

**selos+ fasis**

# DIN RAIL **TERMINAL BLOCKS**

with Screw, Tension Spring and  
Push-In Connection Technologies.

# HELLO WIELAND ELECTRIC

Over 100 years of safe connections.

We are the inventor of safe electrical connection technology and are committed to individual and safe system solutions.

Together with our broad product portfolio we offer comprehensive services for industry applications as well as building installation and lighting technology.

All our experience amounted to us being the global market leader for pluggable, electrical installation in commercial buildings and competent partner for machine safety. Our solutions are designed for you to be safe and secure. At the same time, we ensure you that you integrate our systems fast and easy. This saves you time and costs. Thanks to our modular solutions your requirements can be executed failsafe, fast and flexible.

We do business worldwide with subsidiaries, production facilities and sales partners and have an excellent global network. Our teams are supporting customers and projects on all continents – personally and individually. Our competences in engineering, production and logistics processes are interlinked with each other for maximum efficiency.

We are looking forward to be your partner.



**1910**

founded in  
Bamberg



**1.600+**

employees  
worldwide



**6**

production  
sites



**70+**

countries  
worldwide

# CONTENT

---

<b>04</b>	One System, many Possibilities
<b>06</b>	Wieland DIN Rail Terminal Blocks – Overview
<b>08</b>	wieplan CLICK2BUY
<b>10</b>	selos – DIN Rail Terminal Blocks with Screw Connection
<b>48</b>	selos WRT – The New Generation of High Current Terminals
<b>58</b>	selos BIT – Terminal Blocks for Electrical Installations with Screw Connection
<b>64</b>	selos CLASSIC – DIN Rail Terminal Blocks with Screw Connection, Type 9700 A.. S35
<b>70</b>	fasis WKFN – DIN Rail Terminal Blocks with Tension Spring Connection
<b>106</b>	fasis CON – DIN Rail Terminal Blocks with Plug-In Connection
<b>116</b>	fasis MINI – DIN Rail Terminal Blocks with Tension Spring Connection for Installation in Confined Spaces
<b>122</b>	fasis BIT – DIN Rail Terminals for Installation distribution Board with Tension Spring Connection
<b>128</b>	fasis WTP – DIN Rail Terminal Blocks with Push-In Connection
<b>144</b>	Accessories
<b>172</b>	Tables, technical Data
<b>186</b>	Service, Your Contact Partner



## DIN RAIL TERMINAL BLOCKS WITH SCREW CONNECTION – SELOS

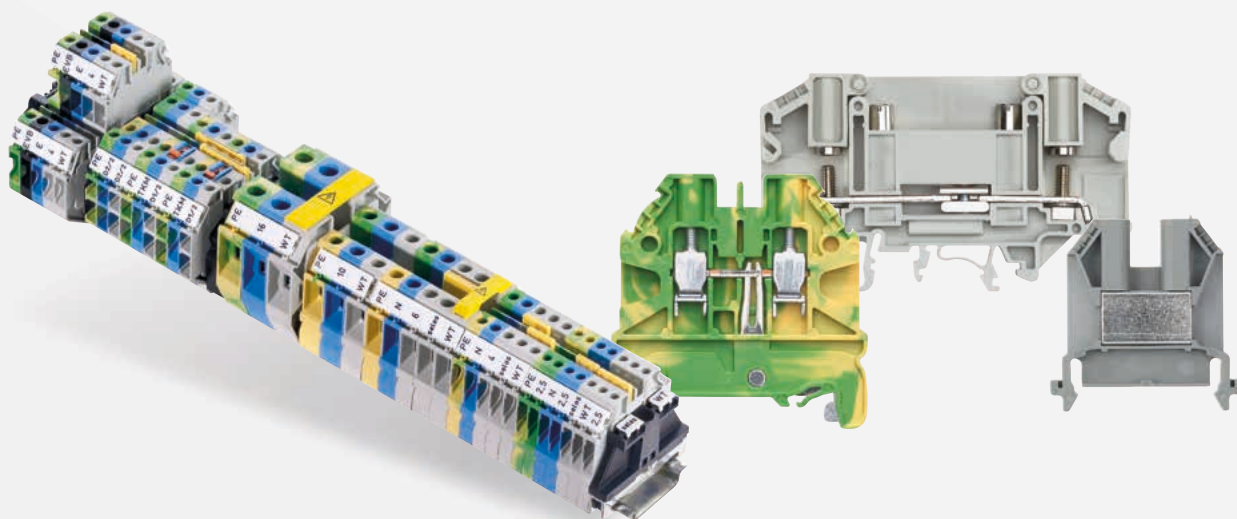

## DIN RAIL TERMINAL BLOCKS WITH PUSH-IN CONNECTION – FASIS WTP

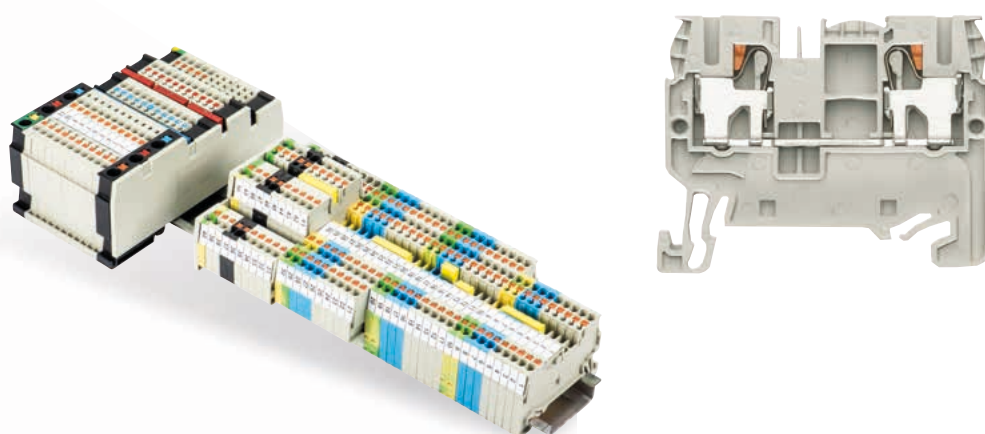

## DIN RAIL TERMINAL BLOCKS WITH TENSION SPRING CONNECTION – FASIS WKFN

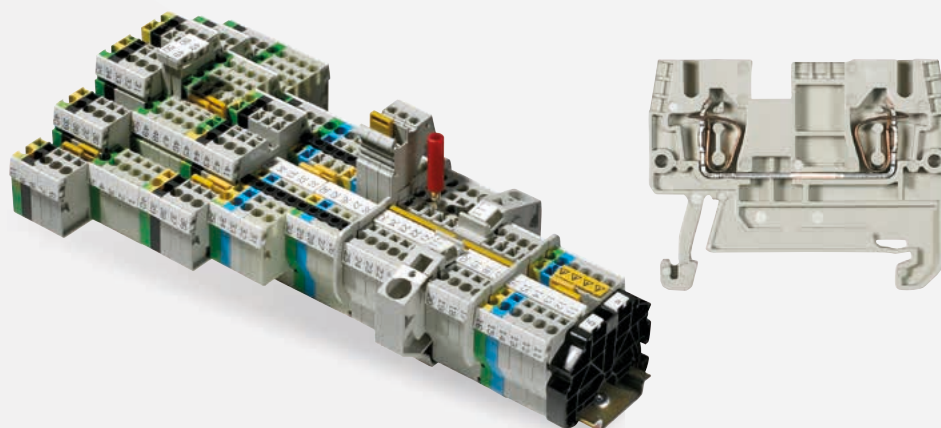



# ONE SYSTEM – MANY POSSIBILITIES

Three product families, three connection technologies – our DIN rail terminal block program is the right choice for every installation, wherever the control cabinet is found – in machinery or plant engineering, energy technology or building installation, or with screw, tension spring or push-in connection.

The ultimately flexible DIN rail terminal block systems selos and fasis offer optimum handling and harmonized accessories. This guarantees not only fast wiring time, but also reduces cost of inventory at your facility and in the supply chain.

Customized assembly service, customer-specific solutions and a comprehensive service portfolio match our products individually with the requirements of our customers.

## ACCESSORIES, SOFTWARE AND SERVICE





# WIELAND DIN RAIL TERMINAL BLOCKS – OVERVIEW

## DIN RAIL TERMINAL BLOCKS WITH SCREW CONNECTION

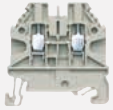

Feed-through blocks  
starting at page 14



Ground blocks  
starting at page 18

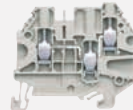

Duo feed-through blocks  
starting at page 22

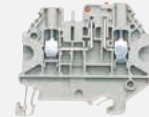

Knife edge  
disconnect blocks  
starting at page 22 + 33

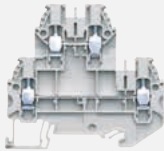

Multi-tier blocks  
starting at page 24



Initiator blocks  
starting at page 28



Fuse blocks  
starting at page 30



DIN rail terminal blocks with  
plug-in connection  
starting at page 36



Function blocks  
starting at page 26 + 40



Instrument isolating  
terminals  
starting at page 42

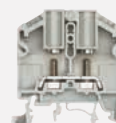

DIN rail terminal blocks with ring  
lug connection  
starting at page 47



High current terminal blocks  
starting at page 48



Mini blocks  
starting at page 56

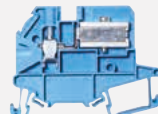

DIN rail terminal blocks for  
installation distribution boards  
starting at page 58

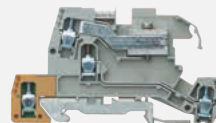

Triple-deck terminal blocks for  
installation distribution boards  
starting at page 62



selos CLASSIC  
starting at page 64

## SOFTWARE page 8 / 9





## DIN RAIL TERMINAL BLOCKS WITH TENSION SPRING CONNECTION

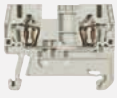

Feed-through blocks  
starting at page 74



Ground blocks  
starting at page 82

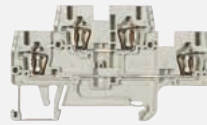

Multi-tier blocks  
starting at page 90



Knife edge  
disconnect blocks  
starting at page 100

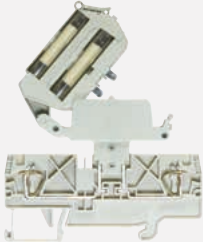

Fuse blocks  
starting at page 102



DIN rail terminal blocks with  
plug-in connection  
starting at page 106

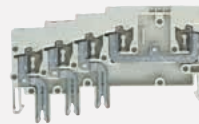

Initiator blocks  
starting at page 112



Mini blocks  
starting at page 116

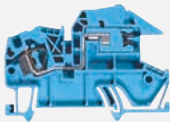

DIN rail terminal blocks for  
installation distribution boards  
starting at page 123



Triple-deck terminal blocks for instal-  
lation distribution boards starting at  
page 126

## DIN RAIL TERMINAL BLOCKS WITH PUSH-IN CONNECTION



Feed-through blocks  
starting at page 132

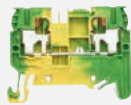

Ground blocks  
starting at page 133

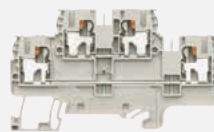

Multi-tier blocks  
starting at page 134

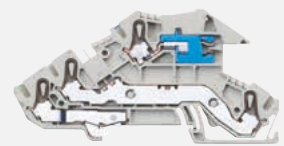

Triple-deck terminal blocks for instal-  
lation distribution boards starting at  
page 142

## ACCESSORIES starting at page 144

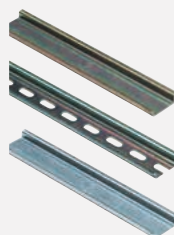

## SERVICE starting at page 172





# WIEPLAN CLICK2BUY

**Online** terminal block configurator.

The **quick** way to a complete **pre-assembled DIN RAIL**:

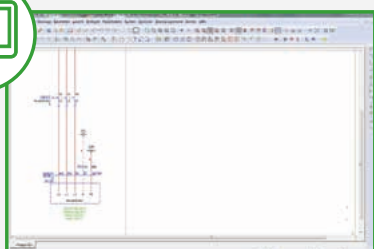

Design in CAE system



Product selection

STEP  
**01**

STEP  
**02**

## QUICKER PLANNING

The simple integration of wieplan into your CAE environment will enable you to plan and respond much more quickly (with EPLAN CAE already integrated).

## COMPLETE DOCUMENTATION

At the touch of a button you can download the complete documentation for your configured terminal strips including parts lists – even without registering.

## QUICK PRICING

It is worth registering with wieplan Click to Buy as users who are logged in see our prices immediately – and can order directly.

Speed up **processes**.  
Use **opportunities**.

Meet tight deadlines and make design changes at short notice without any worry. As your partner we are set up to deal with short timeframes and small batch sizes – delivering on time without any errors. You can count on this!

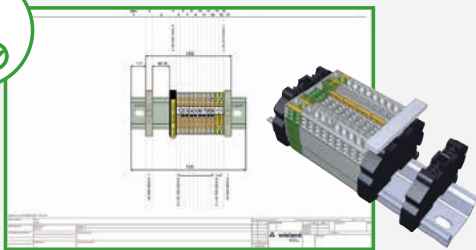

**Documentation**

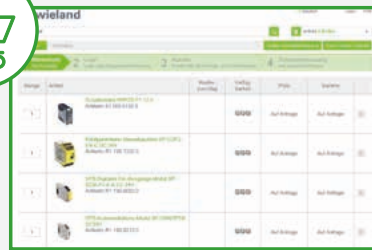

**Immediate pricing**

STEP  
**03**

STEP  
**04**

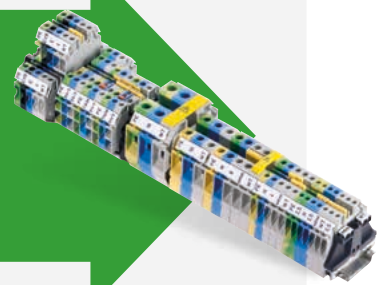

**EXPERIENCE INDUSTRY 4.0**

This consistent networking approach means that your order will go straight into production here – without any detours or delays.

**NO MINIMUM QUANTITY**

Whether the batch size is 1 or 1,000, we will deliver the exact quantity you need – starting from just 1 piece. This will also save you high warehousing and logistics costs.

**NO ADDITIONAL EFFORT**

The tested terminal strips are customized and will be tailored precisely to your needs. We will deliver them ready-made, saving you additional work.



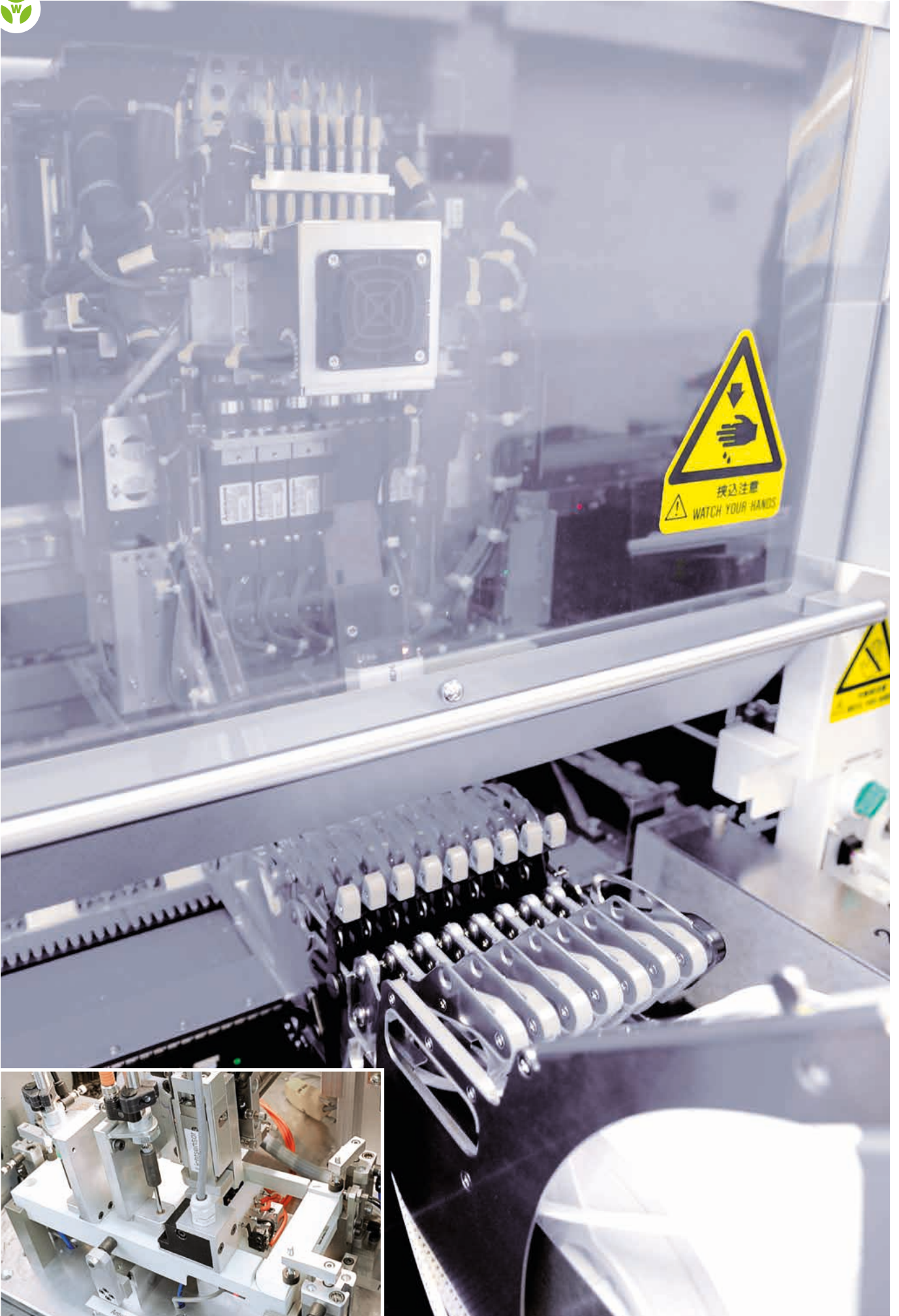

# SELOS

## DIN RAIL TERMINAL BLOCKS WITH **SCREW CONNECTION**

Reliable connection, proven concept! selos is our DIN rail terminal block with screw connection, solid and functional, known worldwide, and in use millions of times over.

The selos series combines the classic screw connection with modern connection technology, with the focus on customer benefits and increased efficiency in wiring and the supply chain.

The selos CLASSIC series offers the highest-quality connecting technology. Thanks to its unique clamping body design, aluminum or copper wire connections are long-lasting and maintenance-free.

The selos product line includes feed-through and ground blocks with 2, 3 or 4 termination points, multi-tier blocks in two- and three-tier designs, knife-edge disconnect blocks and fuse blocks. In addition, specialty function blocks are available with a wide variety of diode circuits and diverse application-specific terminals, such as transformer disconnect terminals.

selos has been designed for use in machinery and plant construction as well as hazardous locations subject to explosion.

Connection cross-section up to 300 mm<sup>2</sup>  
Rated current up to 520 A  
Rated voltage up to 1000 V

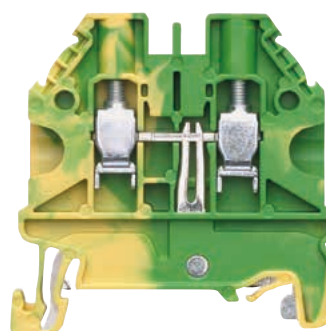
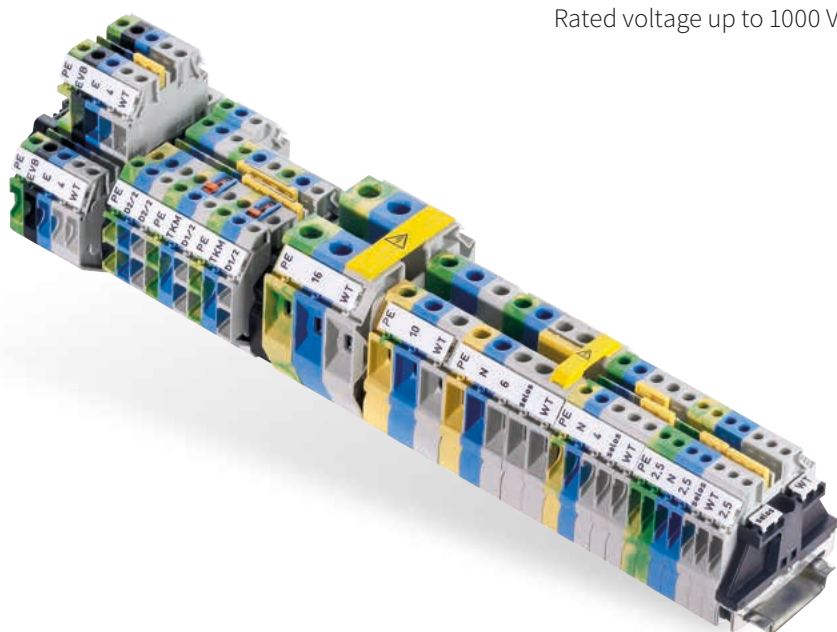



# DIN RAIL TERMINAL BLOCKS WITH **SCREW CONNECTION**

- **SMALLER SIZE**
- **UNIFORM DESIGN**
- **FEWER ACCESSORIES**

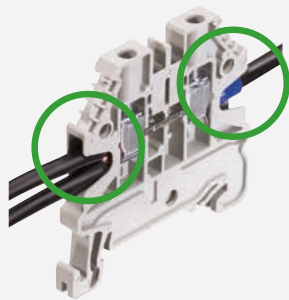
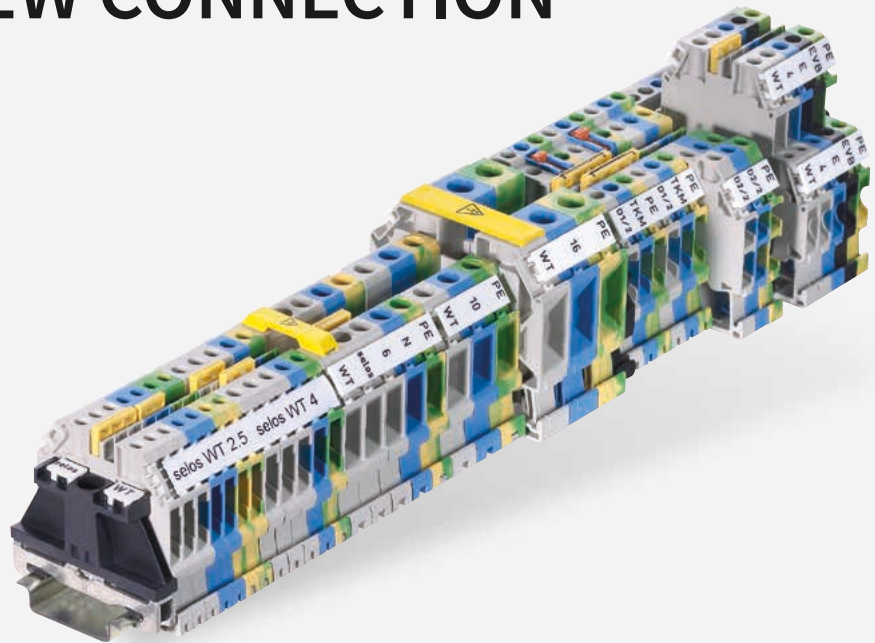

## **SIMPLY CONNECT**

- Multi-wire connection
- Connect with or without ferrules

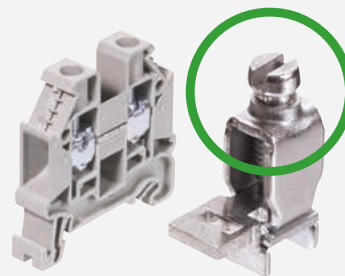

## **RELIABLE AND MAINTENANCE-FREE**

- Rugged clamping body design
- One-piece threaded collar
- Stress-free connecting and reconnecting

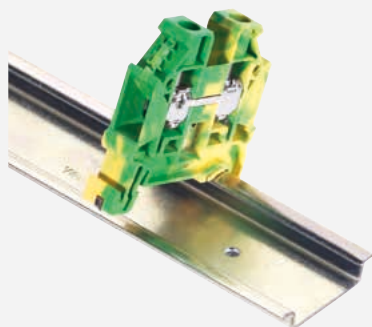

## **TIME-SAVING ASSEMBLY**

- Snap-on screwless ground blocks

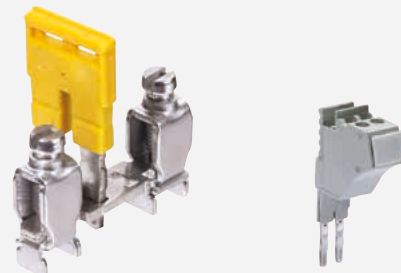

## **PLUG & PLAY**

- Dual jumpering channels
- Plug-in jumper bars
- Plug-in test adapter



## WIELAND JUMPERING SYSTEM – PERFECT TECHNOLOGY

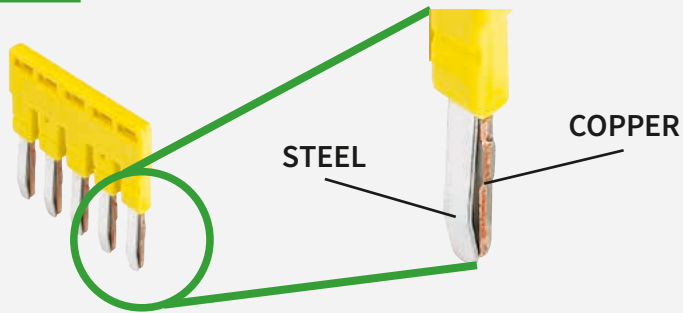

### PERFECT TECHNOLOGY

- Copper current bar guarantees low contact resistance
- Steel spring guarantees strength, durability, and long-term stability

### EXTREMELY RUGGED!

- Indestructible steel spring
- Vibration-proof connection



### SIMPLE CUSTOMIZATION

- Individual-poles easy to remove
- Circuits easy to identify

## WIELAND MARKING SYSTEM – RELIABLE IDENTIFICATION



### MARKING STRIPS – DEPENDABLE

- Maximum hold to the terminal
- Solidify integrity of rail assembly

### ENDLESS STRIP – EFFECTIVE

- Mounting facility for endless strips permits single step marking of entire assembly
- Continuous labeling
- Uses commercially available labeling systems



### MARKING TAGS – INDIVIDUAL



- Individual labeling with minimum effort
- Ideal for service and maintenance

# FEED-THROUGH BLOCKS WITH SCREW CONNECTION

## WT 2,5

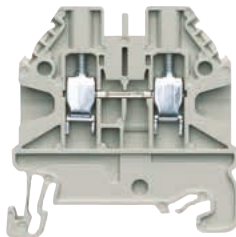
- Feed-through block with screw connection for mounting on TS 35
- Nominal cross section 2.5 mm<sup>2</sup>
-  II 2G 2D Ex eb IIC  
EN 60079-0:12+A11:13 / IEC 60079-0:2011 Ed:6.0  
EN 60079-7:07 / IEC 60079-7:2006-07 Ed:4  
Follow the EX installation instructions on page 174
- Max. electrical data: 32 A / 4 mm<sup>2</sup>
- Connection capacity: 2 wires, equal size  
0.14 – 1.5 mm<sup>2</sup>





Description	Type	Part No.	Std. Pack	
Feed-through block	gray WT 2,5	58.503.0055.0	100	
Feed-through block	blue WT 2,5 BL	58.503.0055.6	100	
GENERAL DATA				
Width / length / height, incl. TS 7.5	5 mm / 48 mm / 48 mm			
Wire strip length	9 mm		IEC Ex SEV14.0004 U	
Approvals	  ATEX IEC Ex		SEV 14 ATEX 0124 U	
TECHNICAL DATA				
	IEC	UL	CSA	
	EN 60 947-7-1			
Cross section fine-stranded	0.14 – 4 mm <sup>2</sup>		0.14 – 4 mm <sup>2</sup>	
Cross section solid/stranded	0.14 – 4 mm <sup>2</sup>		0.14 – 4 mm <sup>2</sup>	
Cross section, AWG	26 – 12		26 – 12	
Rated current	24 A	20 A	20 A	24 A
Rated voltage	1000 V	600 V	600 V	690 V
Rated impulse voltage	8 kV			
Pollution degree	3			
ACCESSORIES				
	Type	Part No.	Std. Pack	
End plate	AP WT 2,5-10	07.313.2555.0	10	
Cross connector	2-pole	IVB WKF 2,5-2	10	
	3-pole	IVB WKF 2,5-3	10	
	4-pole	IVB WKF 2,5-4	10	
	5-pole	IVB WKF 2,5-5	10	
	10-pole	IVB WKF 2,5-10	20	
	20-pole	IVB WKF 2,5-20	20	

## WT 4

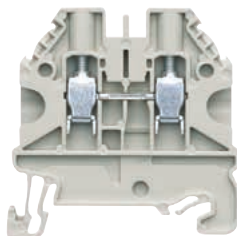
- Feed-through block with screw connection for mounting on TS 35
- Nominal cross section 4 mm<sup>2</sup>
-  II 2G 2D Ex eb IIC  
EN 60079-0:12+A11:13 / IEC 60079-0:2011 Ed:6.0  
EN 60079-7:07 / IEC 60079-7:2006-07 Ed:4  
Follow the EX installation instructions on page 174
- Max. electrical data: 41 A / 6 mm<sup>2</sup>
- Connection capacity: 2 wires, equal size  
0.14 – 2.5 mm<sup>2</sup>





Description	Type	Part No.	Std. Pack	
Feed-through block	gray WT 4	58.504.0055.0	100	
Feed-through block	blue WT 4 BL	58.504.0055.6	100	
GENERAL DATA				
Width / length / height, incl. TS 7.5	6 mm / 48 mm / 48 mm			
Wire strip length	9 mm		IEC Ex SEV 14.0004 U	
Approvals	  ATEX IEC Ex		SEV 14 ATEX 0124 U	
TECHNICAL DATA				
	IEC	UL	CSA	
	EN 60 947-7-1			
Cross section fine-stranded	0.14 – 6 mm <sup>2</sup>		0.14 – 6 mm <sup>2</sup>	
Cross section solid/stranded	0.14 – 6 mm <sup>2</sup>		0.14 – 6 mm <sup>2</sup>	
Cross section, AWG	26 – 10		26 – 10	
Rated current	32 A	30 A	30 A	32 A
Rated voltage	1000 V	600 V	600 V	690 V
Rated impulse voltage	8 kV			
Pollution degree	3			
ACCESSORIES				
	Type	Part No.	Std. Pack	
End plate	AP WT 2,5-10	07.313.2555.0	10	
Cross connector	2-pole	IVB WKF 4-2	10	
	3-pole	IVB WKF 4-3	10	
	4-pole	IVB WKF 4-4	10	
	5-pole	IVB WKF 4-5	10	
	10-pole	IVB WKF 4-10	20	

## WT 6

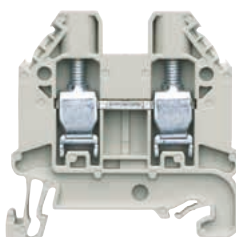
- Feed-through block with screw connection for mounting on TS 35
- Nominal cross section 6 mm<sup>2</sup>
-  II 2G 2D Ex eb IIC  
EN 60079-0:12+A11:13 / IEC 60079-0:2011 Ed:6.0  
EN 60079-7:07 / IEC 60079-7:2006-07 Ed:4  
Follow the EX installation instructions on page 174
- Max. electrical data: 57 A / 10 mm<sup>2</sup>
- Connection capacity: 2 wires, equal size  
0.2 – 4 mm<sup>2</sup>



Description	Type	Part No.	Std. Pack	
Feed-through block	gray WT 6	58.506.0055.0	100	
Feed-through block	blue WT 6 BL	58.506.0055.6	100	
GENERAL DATA				
Width / length / height, incl. TS 7.5	8 mm / 48 mm / 48 mm			
Wire strip length	11 mm		IEC Ex SEV 14.0004 U	
Approvals	  ATEX IEC Ex		SEV 14 ATEX 0124 U	
TECHNICAL DATA				
	IEC	UL	CSA	
	EN 60 947-7-1			
Cross section fine-stranded	0.2 – 10 mm <sup>2</sup>		0.2 – 10 mm <sup>2</sup>	
Cross section solid/stranded	0.2 – 10 mm <sup>2</sup>		0.2 – 10 mm <sup>2</sup>	
Cross section, AWG	24 – 8		24 – 8	
Rated current	41 A	50 A	50 A	41 A
Rated voltage	1000 V	600 V	600 V	550 V
Rated impulse voltage	8 kV			
Pollution degree	3			
ACCESSORIES				
	Type	Part No.	Std. Pack	
End plate	AP WT 2,5-10	07.313.2555.0	10	
Cross connector	2-pole	IVB WKFN 6-2	10	
	3-pole	IVB WKFN 6-3	10	
	4-pole	IVB WKFN 6-4	10	
	5-pole	IVB WKFN 6-5	10	



## WT 10

- Feed-through block with screw connection for mounting on TS 35
- Nominal cross section 10 mm<sup>2</sup>
- II 2G 2D Ex eb IIC  
EN 60079-0:12+A11:13 / IEC 60079-0:2011 Ed:6.0  
EN 60079-7:07 / IEC 60079-7:2006-07 Ed:4  
Follow the EX installation instructions on page 174
- Max. electrical data: 76 A / 16 mm<sup>2</sup>
- Connection capacity: 2 wires, equal size  
0.5 – 6 mm<sup>2</sup>

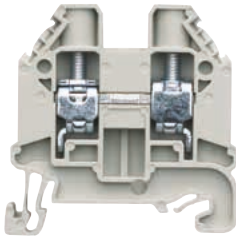

Description	Type	Part No.	Std. Pack
Feed-through block	gray WT 10	58.510.0055.0	50
Feed-through block	blue WT 10 BL	58.510.0055.6	50

GENERAL DATA					
Width / length / height, incl. TS 7.5	10 mm / 48 mm / 48 mm				
Wire strip length	13 mm			IEC Ex SEV 14.0004 U	
Approvals				SEV 14 ATEX 0124 U	
TECHNICAL DATA		IEC	UL	CSA	
		EN 60 947-7-1			
Cross section fine-stranded	0.5 – 16 mm <sup>2</sup>			0.5 – 16 mm <sup>2</sup>	
Cross section solid/stranded	0.5 – 16 mm <sup>2</sup>			0.5 – 16 mm <sup>2</sup>	
Cross section, AWG	20 – 6		20 – 6		
Rated current	57 A	65 A	65 A	57 A	
Rated voltage	1000 V	600 V	600 V	690 V	
Rated impulse voltage	8 kV				
Pollution degree	3				

ACCESSORIES	Type	Part No.	Std. Pack
End plate	AP WT 2,5-10	07.313.2555.0	10
Cross connector	2-pole IVB WKF 10-2	Z7.283.8227.0	10

## WT 16

- Feed-through block with screw connection for mounting on TS 35
- Nominal cross section 16 mm<sup>2</sup>
- II 2G 2D Ex eb IIC  
EN 60079-0:12+A11:13 / IEC 60079-0:2011 Ed:6.0  
EN 60079-7:07 / IEC 60079-7:2006-07 Ed:4  
Follow the EX installation instructions on page 174
- Max. electrical data: 101 A / 25 mm<sup>2</sup>
- Connection capacity: 2 wires, equal size  
2.5 – 10 mm<sup>2</sup>

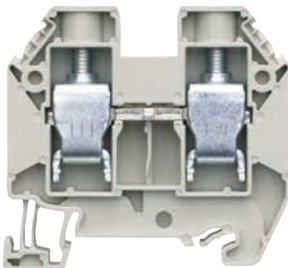

Description	Type	Part No.	Std. Pack
Feed-through block	gray WT 16	58.516.0055.0	50
Feed-through block	blue WT 16 BLAU	58.516.0055.6	50

GENERAL DATA					
Width / length / height, incl. TS 7.5	12 mm / 58 mm / 54mm				
Wire strip length	15 mm			IEC Ex SEV 14.0004 U	
Approvals				SEV 14 ATEX 0124 U	
TECHNICAL DATA		IEC	UL	CSA	
		EN 60 947-7-1			
Cross section fine-stranded	4 – 25 mm <sup>2</sup>			4 – 25 mm <sup>2</sup>	
Cross section solid/stranded	1.5 – 25 mm <sup>2</sup>			1.5 – 25 mm <sup>2</sup>	
Cross section, AWG	16 – 4		14 – 4		
Rated current	76 A	85 A	85 A	76 A	
Rated voltage	1000 V	600 V	600 V	690 V	
Rated impulse voltage	8 kV				
Pollution degree	3				

ACCESSORIES	Type	Part No.	Std. Pack
End plate	AP WT 16	07.313.2755.0	10
Cross connector	2-pole IVB WKF 16-2	Z7.284.4227.0	10

## ACCESSORIES FOR SELOS WT 2,5 – WT 16

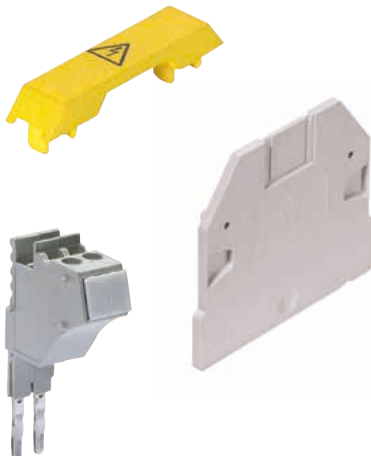

ACCESSORIES	Type	Part No.	Std. Pack	
Cover with warning symbol	for WT 2,5	AD WT 2,5	04.344.1455.8	10
	for WT 4	AD WT 4	04.344.1655.8	10
	for WT 6	AD WT 6/10	04.344.1855.8	10
	for WT 10	AD WT 6/10	04.344.1855.8	10
	for WT 16	AD WT 16	04.344.2255.8	10
Partition for WT 2,5 – WT 10	TW WT 2,5-10	07.313.2655.0	10	
Partition for WT 16	TW WT 4E	07.313.2855.0	10	
Test adapter modular for WT 2,5 and 4	PS WKC/F	Z1.299.9753.0	10	
End plate for test adapter *	ZP/AP PS	07.312.6053.0	10	

\* for WT4 an end cover plate must be snapped in after each test connector

# FEED-THROUGH BLOCKS WITH SCREW CONNECTION

## WKN 35 / U

- Feed-through block with screw connection for mounting on TS 35 and TS 32
- Nominal cross section 35 mm<sup>2</sup>
- Ex e I/II  II 2GD IM2  
Follow the EX installation instructions on page 174
- Enclosed design

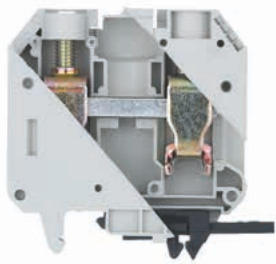

Description	Type	Part No.	Std. Pack
Feed-through block	gray WKN 35/U	57.535.0155.0	20
Feed-through block Exi	blue WKN 35/U BLAU	57.535.0155.6	20

GENERAL DATA			
Width / length / height, incl. TS 7.5	16 mm / 71 mm / 68 mm		
Wire strip length	18 mm		
Approvals	 IECEx SEV 15.0002 U SEV 15 ATEX 0108 U		

TECHNICAL DATA	IEC	UL	CSA	
	EN 60 947-7-1			EN 60 079-0/-7
Cross section fine-stranded	10 – 35 mm <sup>2</sup>	10 – 1/0 AWG	10 – 1/0 AWG	10 – 35 mm <sup>2</sup>
Cross section solid/stranded	10 – 50 mm <sup>2</sup>			10 – 50 mm <sup>2</sup>
Rated current	125 A	150 A	150 A	125 A
Rated voltage	800 V *)	600 V	600 V	690 V <sup>1)</sup>
Rated impulse voltage	8 kV			
Pollution degree	3			

ACCESSORIES	Type	Part No.	Std. Pack
Partition	gray TWN 35	07.311.7855.0	10
Cross connector with screws, insulated	2-pole	IVB WKN 35 - 2	5
	3-pole	IVB WKN 35 - 3	5
	up to 6-pole	IVB WKN 35 - 6	5
	up to 12-pole	IVB WKN 35 - 12	5
Single cover with marking facility	AD VB 35 GELB	04.326.2553.8	10
Cover with warning symbol over 4 blocks	AD VB 16/4 GELB	04.343.5256.8	10

\*) higher voltage upon request

## WKN 70 / U

- Feed-through block with screw connection for mounting on TS 35 and TS 32
- Nominal cross section 70 mm<sup>2</sup>
- Ex e I/II  II 2GD IM2  
Follow the EX installation instructions on page 174
- Enclosed design

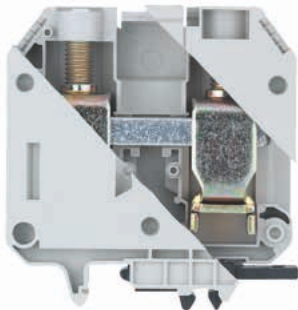

Description	Type	Part No.	Std. Pack
Feed-through block	gray WKN 70/U	57.570.0155.0	20
Feed-through block Exi	blue WKN 70/U BLAU	57.570.0155.6	20

GENERAL DATA			
Width / length / height, incl. TS 7.5	24 mm / 77 mm / 81 mm		
Wire strip length	24 mm		
Approvals	 IECEx SEV 15.0002 U SEV 15 ATEX 0108 U		

TECHNICAL DATA	IEC	UL	CSA	
	EN 60 947-7-1			EN 60 079-0/-7
Cross section fine-stranded	10 – 70 mm <sup>2</sup>	6 – 2/0 AWG	6 – 2/0 AWG	10 – 70 mm <sup>2</sup>
Cross section solid/stranded	16 – 95 mm <sup>2</sup>			16 – 95 mm <sup>2</sup>
Rated current	192 A	175/175 A	170 A	192 A
Rated voltage	800 V *)	600 V	600 V	690 V
Rated impulse voltage	8 kV			
Pollution degree	3			

ACCESSORIES	Type	Part No.	Std. Pack
Partition	gray TWN 70	07.311.7955.0	10
Cross connector with screws, insulated	2-pole	VB WKN 70 - 2	10
	3-pole	VB WKN 70 - 3	10
	up to 6-pole	VB WKN 70 - 6	10
Single cover with marking facility	AD VB 70 GELB	04.326.2653.8	10
Cover with warning symbol over 4 blocks	AD VB 24/4 GELB	04.343.5356.8	10

\*) higher voltage upon request

## WKN 150 / U

- Feed-through block with screw connection for mounting on TS 35 and TS 32
- Nominal cross section 150 mm<sup>2</sup>
- Ex e I/II  II GD IM2  
Follow the EX installation instructions on page 174
- Enclosed design

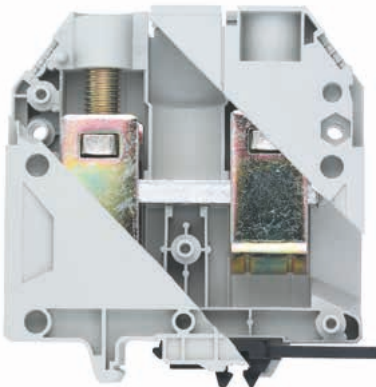

Description	Type	Part No.	Std. Pack
Feed-through block	gray WKN 150/U	57.597.0155.0	10
Feed-through block Exi	blue WKN 150/U BLAU	57.597.0155.6	10

GENERAL DATA			
Width / length / height, incl. TS 7.5	28 mm / 96 mm / 99 mm		
Wire strip length	30 mm		
Approvals	 IECEx SEV 15.0002 U SEV 15 ATEX 0108 U		

TECHNICAL DATA	IEC	UL	CSA	
	EN 60 947-7-1			EN 60 079-0/-7
Cross section fine-stranded	35 – 150 mm <sup>2</sup>	2/0 AWG-350 kcmil	2/0 AWG-350 kcmil	35 – 150 mm <sup>2</sup>
Cross section solid/stranded	35 – 185 mm <sup>2</sup>			35 – 185 mm <sup>2</sup>
Rated current	309 A	335/335 A	365 A	309 A
Rated voltage	1000 V	600 V	1000 V	690 V
Rated impulse voltage	8 kV			
Pollution degree	3			

ACCESSORIES	Type	Part No.	Std. Pack
Partition	gray		
Cross connector with screws, insulated	2-pole	VB WKN 150 - 2	5
	3-pole	VB WKN 150 - 3	5
Cover with warning symbol over 4 blocks	AD VB 28/4 GELB	04.343.5456.8	10

## SUPPLY SET

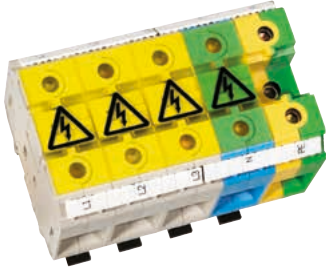

Description	Type	Part No.	Std. Pack
Supply set	WKN 70 3D/N/SL/U	57.570.9855.0	1
Supply set	WKN 70 3D/2N/SL/U	57.570.9955.0	1
Supply set	WKN 150/70 3D/N/SL/U	57.597.9855.0	1
Supply set	WKN 150/3D/N/U	57.597.9955.0	1



<sup>1)</sup> For maintaining the proper isolation distances, the open side of a feed-through terminal block as well as both sides of a jumper are to be enclosed by partitions

# GROUND BLOCKS WITH SCREW CONNECTION

## WT 2,5 PE

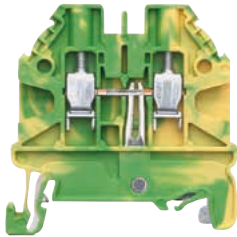
- Ground block with screw connection for mounting on TS 35
- Nominal cross section 2.5 mm<sup>2</sup>
-  II 2G 2D Ex eb IIC  
EN 60079-0:12+A11:13 / IEC 60079-0:2011 Ed:6.0  
EN 60079-7:07 / IEC 60079-7:2006-07 Ed:4  
Follow the EX installation instructions on page 174
- Connection capacity: 2 wires, equal size 0.14 – 1.5 mm<sup>2</sup>





Description	Type	Part No.	Std. Pack
Ground block	green/yellow WT 2,5 PE	58.503.9055.0	100
<b>GENERAL DATA</b>			
Width / length / height, incl. TS 7.5	5 mm / 48 mm / 48 mm		
Wire strip length	9 mm		
Approvals	   IEC Ex SEV 14.0004 U SEV 14 ATEX 0124 U		
<b>TECHNICAL DATA</b>			
	<b>IEC</b>	<b>UL</b>	<b>CSA</b>
	EN 60 947-7-2		
Cross section fine-stranded	0.14 – 4 mm <sup>2</sup>		0.14 – 4 mm <sup>2</sup>
Cross section solid/stranded	0.14 – 4 mm <sup>2</sup>		0.14 – 4 mm <sup>2</sup>
Cross section, AWG	26 – 12		26 – 12
Rated current			
Rated voltage	1000 V		600 V
Rated impulse voltage	8 kV		600 V
Pollution degree	3		
<b>ACCESSORIES</b>			
End plate	AP WT 2,5 - 10	07.313.2555.0	10

## WT 4 PE

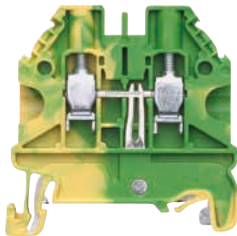
- Ground block with screw connection for mounting on TS 35
- Nominal cross section 4 mm<sup>2</sup>
-  II 2G 2D Ex eb IIC  
EN 60079-0:12+A11:13 / IEC 60079-0:2011 Ed:6.0  
EN 60079-7:07 / IEC 60079-7:2006-07 Ed:4  
Follow the EX installation instructions on page 174
- Connection capacity: 2 wires, equal size 0.14 – 2.5 mm<sup>2</sup>





Description	Type	Part No.	Std. Pack
Ground block	green/yellow WT 4 PE	58.504.9055.0	100
<b>GENERAL DATA</b>			
Width / length / height, incl. TS 7.5	6 mm / 48 mm / 48 mm		
Wire strip length	9 mm		
Approvals	   IEC Ex SEV 14.0004 U SEV 14 ATEX 0124 U		
<b>TECHNICAL DATA</b>			
	<b>IEC</b>	<b>UL</b>	<b>CSA</b>
	EN 60 947-7-2		
Cross section fine-stranded	0.14 – 6 mm <sup>2</sup>		0.14 – 6 mm <sup>2</sup>
Cross section solid/stranded	0.14 – 6 mm <sup>2</sup>		0.14 – 6 mm <sup>2</sup>
Cross section, AWG	26 – 10		26 – 10
Rated current			
Rated voltage	1000 V		600 V
Rated impulse voltage	8 kV		600 V
Pollution degree	3		
<b>ACCESSORIES</b>			
End plate	AP WT 2,5 - 10	07.313.2555.0	10

## WT 6 PE

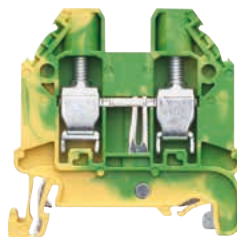
- Ground block with screw connection for mounting on TS 35
- Nominal cross section 6 mm<sup>2</sup>
-  II 2G 2D Ex eb IIC  
EN 60079-0:12+A11:13 / IEC 60079-0:2011 Ed:6.0  
EN 60079-7:07 / IEC 60079-7:2006-07 Ed:4  
Follow the EX installation instructions on page 174
- Connection capacity: 2 wires, equal size 0.2 – 4 mm<sup>2</sup>



Description	Type	Part No.	Std. Pack
Ground block	green/yellow WT 6 PE	58.506.9055.0	100
<b>GENERAL DATA</b>			
Width / length / height, incl. TS 7.5	8 mm / 48 mm / 48 mm		
Wire strip length	11 mm		
Approvals	   IEC Ex SEV 14.0004 U SEV 14 ATEX 0124 U		
<b>TECHNICAL DATA</b>			
	<b>IEC</b>	<b>UL</b>	<b>CSA</b>
	EN 60 947-7-2		
Cross section fine-stranded	0.2 – 10 mm <sup>2</sup>		0.2 – 10 mm <sup>2</sup>
Cross section solid/stranded	0.2 – 10 mm <sup>2</sup>		0.2 – 10 mm <sup>2</sup>
Cross section, AWG	24 – 8		24 – 8
Rated current			
Rated voltage	1000 V		600 V
Rated impulse voltage	8 kV		600 V
Pollution degree	3		
<b>ACCESSORIES</b>			
End plate	AP WT 2,5 - 10	07.313.2555.0	10

### WT 10 PE

- Ground block with screw connection for mounting on TS 35
- Nominal cross section 10 mm<sup>2</sup>
- II 2G 2D Ex eb IIC  
EN 60079-0:12+A11:13 / IEC 60079-0:2011 Ed:6.0  
EN 60079-7:07 / IEC 60079-7:2006-07 Ed:4  
Follow the EX installation instructions on page 174
- Connection capacity: 2 wires, equal size  
0.5 – 6 mm<sup>2</sup>

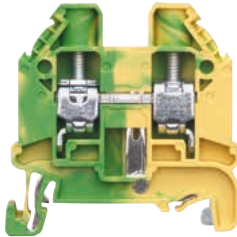

Description	Type	Part No.	Std. Pack
Ground block	green/yellow WT 10 PE	58.510.9055.0	50
<b>GENERAL DATA</b>			
Width / length / height, incl. TS 7.5	10 mm / 48 mm / 48 mm		
Wire strip length	13 mm	IEC Ex SEV 14.0004 U	
Approvals		SEV 14 ATEX 0124 U	
<b>TECHNICAL DATA</b>			
	<b>IEC</b>	<b>UL</b>	<b>CSA</b>
	EN 60 947-7-2		
Cross section fine-stranded	0.5 – 16 mm <sup>2</sup>		0.5 – 16 mm <sup>2</sup>
Cross section solid/stranded	0.5 – 16 mm <sup>2</sup>		0.5 – 16 mm <sup>2</sup>
Cross section, AWG		20 – 6	20 – 6
Rated current			
Rated voltage	1000 V	600 V	600 V
Rated impulse voltage	8 kV		
Pollution degree	3		
<b>ACCESSORIES</b>			
	<b>Type</b>	<b>Part No.</b>	<b>Std. Pack</b>
End plate	AP WT 2,5 - 10	07.313.2555.0	10

### WT 16 PE

- Ground block with screw connection for mounting on TS 35
- Nominal cross section 16 mm<sup>2</sup>
- II 2G 2D Ex eb IIC  
EN 60079-0:12+A11:13 / IEC 60079-0:2011 Ed:6.0  
EN 60079-7:07 / IEC 60079-7:2006-07 Ed:4  
Follow the EX installation instructions on page 174
- Connection capacity: 2 wires, equal size  
2.5 – 10 mm<sup>2</sup>

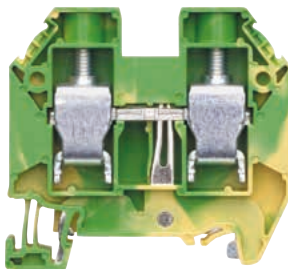

Description	Type	Part No.	Std. Pack
Ground block	green/yellow WT 16 PE	58.516.9055.0	100
<b>GENERAL DATA</b>			
Width / length / height, incl. TS 7.5	12 mm / 58 mm / 54 mm		
Wire strip length	15 mm	IEC Ex SEV 14.0004 U	
Approvals		SEV 14 ATEX 0124 U	
<b>TECHNICAL DATA</b>			
	<b>IEC</b>	<b>UL</b>	<b>CSA</b>
	EN 60 947-7-2		
Cross section fine-stranded	4 – 25 mm <sup>2</sup>		4 – 25 mm <sup>2</sup>
Cross section solid/stranded	1.5 – 25 mm <sup>2</sup>		1.5 – 25 mm <sup>2</sup>
Cross section, AWG		16 – 4	14 – 4
Rated current			
Rated voltage	1000 V	600 V	600 V
Rated impulse voltage	8 kV		
Pollution degree	3		
<b>ACCESSORIES</b>			
	<b>Type</b>	<b>Part No.</b>	<b>Std. Pack</b>
End plate	AP WT 16	07.313.2755.0	10



# GROUND BLOCKS WITH SCREW CONNECTION

## WKN 35 SL

- Ground block with screw connection for mounting on TS 35
- Nominal cross section 35 mm<sup>2</sup>
- Ex e I/II  II 2GD IM2  
Follow the EX installation instructions on page 174
- Enclosed design

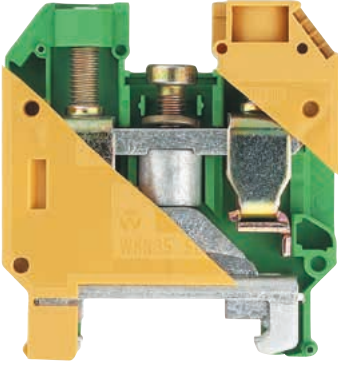

Description	Type	Part No.	Std. Pack
Ground block	green/yellow	WKN 35 SL	57.535.9055.0 20
<b>GENERAL DATA</b>			
Width / length / height, incl. TS 7.5	16 mm / 63 mm / 68 mm		
Wire strip length	20 mm		
Approvals			
	IEC	UL	CSA
	EN 60 947-7-2		
Cross section fine-stranded	10 – 35 mm <sup>2</sup>		
Cross section solid/stranded	10 – 50 mm <sup>2</sup>		
Cross section, AWG	10 – 2		
Rated current	600 V		
Rated voltage	800 V		
Rated impulse voltage	8 kV		
Pollution degree	3		

## WKN 70 SL

- Ground block with screw connection for mounting on TS 35
- Nominal cross section 70 mm<sup>2</sup>
- Ex e I/II  II 2GD IM2  
Follow the EX installation instructions on page 174
- Enclosed design

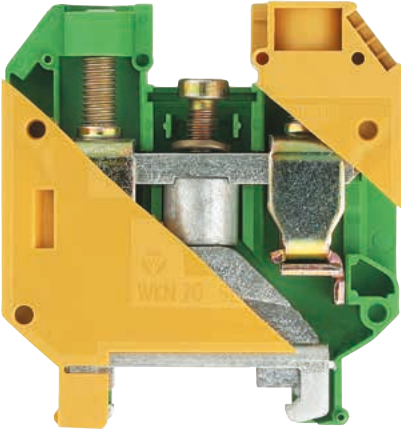

Description	Type	Part No.	Std. Pack
Ground block	green/yellow	WKN 70 SL	57.570.9055.0 20
<b>GENERAL DATA</b>			
Width / length / height, incl. TS 7.5	24 mm / 75 mm / 81 mm		
Wire strip length	24 mm		
Approvals			
	IEC	UL	CSA
	EN 60 947-7-2		
Cross section fine-stranded	10 – 70 mm <sup>2</sup>		
Cross section solid/stranded	16 – 95 mm <sup>2</sup>		
Cross section, AWG	6 – 2/0		
Rated current	600 V		
Rated voltage	800 V		
Rated impulse voltage	8 kV		
Pollution degree	3		

### 9700 A/35 E S 35

- Ground block with screw connection for mounting on TS 35
- Nominal cross section 35 mm<sup>2</sup>

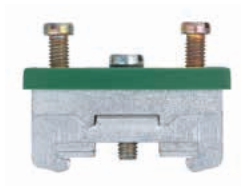

Description	Type	Part No.	Std. Pack
Ground block	green/yellow	9700 A/35 E S 35	Z2.302.0621.0 25
<b>GENERAL DATA</b>			
Width / length / height, incl. TS 7.5	17 mm / 56 mm / 35 mm		
Wire strip length			
Approvals	<b>VDE</b>		
<b>TECHNICAL DATA</b>		<b>IEC</b>	<b>UL</b> <b>CSA</b>
	EN 60 947-7-2		
Cross section fine-stranded	35 mm <sup>2</sup>		
Cross section solid/stranded	50 mm <sup>2</sup>		
Cross section, AWG	8-2		
Rated current			
Rated voltage	600 V		
Rated impulse voltage			
Pollution degree			

### 9700 A/70 E S 35

- Ground block with screw connection for mounting on TS 35
- Nominal cross section 70 mm<sup>2</sup>



Description	Type	Part No.	Std. Pack
Ground block	green/yellow	9700 A/70 E S 35	Z2.302.0421.0 10
<b>GENERAL DATA</b>			
Width / length / height, incl. TS 7.5	25 mm / 57 mm / 57 mm		
Wire strip length			
Approvals	<b>VDE</b>		
<b>TECHNICAL DATA</b>		<b>IEC</b>	<b>UL</b> <b>CSA</b>
	EN 60 947-7-2		
Cross section fine-stranded	70 mm <sup>2</sup>		
Cross section solid/stranded	120 mm <sup>2</sup>		
Cross section, AWG	6-2/0		6-2/0
Rated current			
Rated voltage	600 V		
Rated impulse voltage			
Pollution degree			

# DUO FEED-THROUGH AND DUO-GROUND BLOCKS WITH SCREW CONNECTION

## WT 4 D1/2 | WT 4 D1/2 PE

- Duo feed-through block / duo-ground block with screw connection for mounting on TS 35
- Nominal cross section 4 mm<sup>2</sup>
-  II 2G 2D Ex eb IIC  
EN 60079-0:12+A11:13 / IEC 60079-0:2011 Ed:6.0  
EN 60079-7:07 / IEC 60079-7:2006-07 Ed:4  
Follow the EX installation instructions on page 174
- Max. electrical data: 41 A/6 mm<sup>2</sup>
- Connection capacity: 2 wires, equal size  
0.14 – 2.5 mm<sup>2</sup>

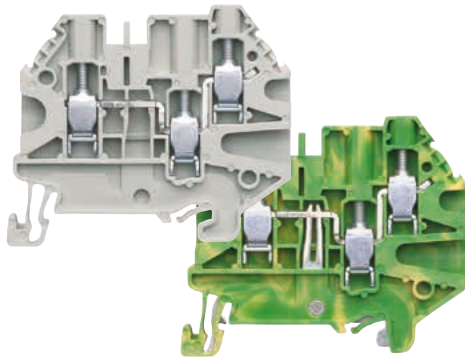

Description	Type	Part No.	Std. Pack
Duo feed-through block	gray WT 4 D1/2	58.504.5055.0	100
Duo feed-through block	blue WT 4 D1/2 BL	58.504.5055.6	100
Duo-ground block	green/yellow WT 4 D1/2 PE	58.504.9355.0	100

GENERAL DATA				
Width / length / height, incl. TS 7.5	6 mm / 56 mm / 50 mm			
Wire strip length	9 mm			IEC Ex SEV 14.0004 U
Approvals				SEV 14 ATEX 0124 U

TECHNICAL DATA	IEC	UL	CSA	
EN 60 947-7-1				
Cross section fine-stranded	0.14 – 6 mm <sup>2</sup>			0.14 – 6 mm <sup>2</sup>
Cross section solid/stranded	0.14 – 6 mm <sup>2</sup>			0.14 – 6 mm <sup>2</sup>
Cross section, AWG	26 – 10			
Rated current	32 A	30 A	30 A	32 A
Rated voltage	500 V	300 V	300 V	550 V
Rated impulse voltage	6 kV			
Pollution degree	3			

ACCESSORIES	Type	Part No.	Std. Pack
End plate	AP WT 4 D1/2	07.313.2955.0	10
Partition	TW WT 4 E	07.313.2855.0	10
Cross connector	2-pole	IVB WKF 4-2	Z7.261.1227.0
	3-pole	IVB WKF 4-3	Z7.261.1327.0
	4-pole	IVB WKF 4-4	Z7.261.1427.0
	5-pole	IVB WKF 4-5	Z7.261.1527.0
	10-pole	IVB WKF 4-10	Z7.261.2027.0

## WT 4 D2/2 | WT 4 D2/2 PE

- Duo feed-through block / duo-ground block with screw connection for mounting on TS 35
- Nominal cross section 4 mm<sup>2</sup>
-  II 2G 2D Ex eb IIC  
EN 60079-0:12+A11:13 / IEC 60079-0:2011 Ed:6.0  
EN 60079-7:07 / IEC 60079-7:2006-07 Ed:4  
Follow the EX installation instructions on page 174
- Max. electrical data: 41 A/6 mm<sup>2</sup>
- Connection capacity: 2 wires, equal size  
0.14 – 2.5 mm<sup>2</sup>

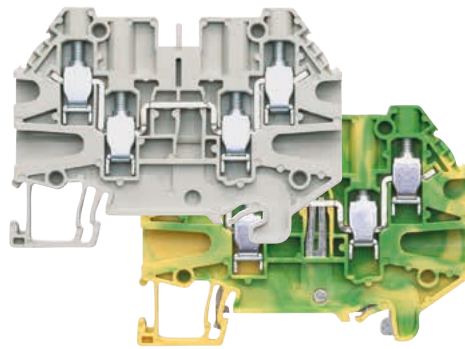

Description	Type	Part No.	Std. Pack
Duo feed-through block	gray WT 4 D2/2	58.504.5155.0	100
Duo feed-through block	blue WT 4 D2/2 BLAU	58.504.5155.6	100
Duo-ground block	green/yellow WT 4 D2/2 PE	58.504.9155.0	100

GENERAL DATA				
Width / length / height, incl. TS 7.5	6 mm / 68 mm / 50 mm			
Wire strip length	9 mm			IEC Ex SEV 14.0004 U
Approvals				SEV 14 ATEX 0124 U

TECHNICAL DATA	IEC	UL	CSA	
EN 60 947-7-1				
Cross section fine-stranded	0.14 – 6 mm <sup>2</sup>			0.14 – 6 mm <sup>2</sup>
Cross section solid/stranded	0.14 – 6 mm <sup>2</sup>			0.14 – 6 mm <sup>2</sup>
Cross section, AWG	26 – 10			
Rated current	32 A	30 A	30 A	32 A
Rated voltage	500 V	300 V	300 V	440 V
Rated impulse voltage	6 kV			
Pollution degree	3			

ACCESSORIES	Type	Part No.	Std. Pack
End plate	AP WT 4 D2/2	07.313.3155.0	10
Partition	TW WT 4 E	07.313.2855.0	10
Cross connector	2-pole	IVB WKF 4-2	Z7.261.1227.0
	3-pole	IVB WKF 4-3	Z7.261.1327.0
	4-pole	IVB WKF 4-4	Z7.261.1427.0
	5-pole	IVB WKF 4-5	Z7.261.1527.0
	10-pole	IVB WKF 4-10	Z7.261.2027.0

# KNIFE EDGE DISCONNECT AND FUSE BLOCKS WITH SCREW CONNECTION

## WT 2,5 TKM...

- Knife edge disconnect block for mounting on TS 35
- Nominal cross section 2,5 mm<sup>2</sup>
- Connection capacity: 2 wires, equal size 0,14 – 1,5 mm<sup>2</sup>

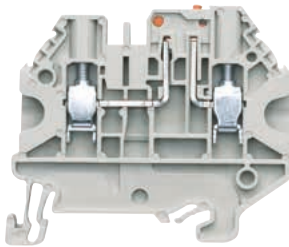

Description	Type	Part No.	Std. Pack
Knife edge disconnect block	gray WT 2,5 TKM	58.503.2055.0	100
Knife edge disconnect block with 2 test bolts	blue WT 2,5 TKM BL gray WT 2,5 TKM P	58.503.2055.6 58.503.2355.0	100 100
Feed-through block, identically-shaped	gray WT 2,5 TKM D	58.503.2155.0	100
Feed-through block, identically-shaped	blue WT 2,5 TKM D BL	58.503.2155.6	100

GENERAL DATA			
Width / length / height, incl. TS 7.5	5 mm / 56 mm / 50 mm		
Wire strip length	9 mm		
Approvals			

TECHNICAL DATA	IEC	UL	CSA
Cross section fine-stranded	0.14 – 4 mm <sup>2</sup>	pending	pending
Cross section solid/stranded	0.14 – 4 mm <sup>2</sup>		
Cross section, AWG			
Rated current	20 A		
Rated voltage	500 V		
Rated impulse voltage	6 kV		
Pollution degree	3		

ACCESSORIES	Type	Part No.	Std. Pack
End plate	AP WT 4 D1/2	07.313.2955.0	10
Partition	TW WT 4 E	07.313.2855.0	10
Cross connector	2-pole	IVB WKF 2,5-2	10
	5-pole	IVB WKF 2,5-5	10
	10-pole	IVB WKF 2,5-10	10
	20-pole	IVB WKF 2,5-20	10

## WT 4 TKM...

- Knife edge disconnect block for mounting on TS 35
- Nominal cross section 4 mm<sup>2</sup>
- Connection capacity: 2 wires, equal size 0,14 – 2,5 mm<sup>2</sup>

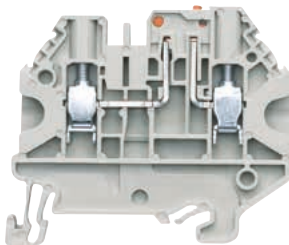

Description	Type	Part No.	Std. Pack
Knife edge disconnect block	gray WT 4 TKM	58.504.2055.0	100
Knife edge disconnect block with 2 test bolts	blue WT 4 TKM BL gray WT 4 TKM P	58.504.2055.6 58.504.2355.0	100 100

GENERAL DATA			
Width / length / height, incl. TS 7.5	6 mm / 56 mm / 50 mm		
Wire strip length	9 mm		
Approvals			

TECHNICAL DATA	IEC	UL	CSA
Cross section fine-stranded	0.14 – 6 mm <sup>2</sup>		
Cross section solid/stranded	0.14 – 6 mm <sup>2</sup>		
Cross section, AWG		26 – 10	26 – 10
Rated current	24 A	16 A	16 A
Rated voltage	500 V	300 V	300 V
Rated impulse voltage	6 kV		
Pollution degree	3		

ACCESSORIES	Type	Part No.	Std. Pack
End plate	AP WT 4 D1/2	07.313.2955.0	10
Partition	TW WT 4 E	07.313.2855.0	10
Cross connector	2-pole	IVB WKF 4-2	10
	5-pole	IVB WKF 4-5	10
	10-pole	IVB WKF 4-10	10

## WT 4 FSI

- Fuse block for automobile fuses (mini) for mounting on TS 35
- Nominal cross section 4 mm<sup>2</sup>
- Connection capacity: 2 wires, equal size 0,14 – 2,5 mm<sup>2</sup>

<sup>1)</sup> Observe the derating curve, available in our e-catalog at <https://eshop.wieland-electric.com>

<sup>2)</sup> determined by the fuse inserted

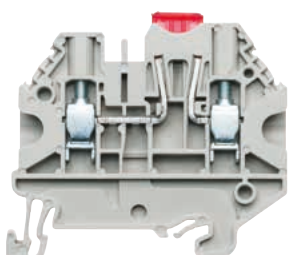

Description	Type	Part No.	Std. Pack
Fuse block	gray WT 4 FSI	58.504.4155.0	100

GENERAL DATA			
Width / length / height, incl. TS 7.5	6 mm / 56 mm / 50 mm		
Wire strip length	9 mm		
Approvals			

TECHNICAL DATA	IEC	UL	CSA
Cross section fine-stranded	0.14 – 6 mm <sup>2</sup>	pending	pending
Cross section solid/stranded	0.14 – 6 mm <sup>2</sup>		
Cross section, AWG			
Rated current	max. 20 A <sup>1)</sup>		
Rated voltage	<sup>2)</sup>		
Rated impulse voltage	6 kV		
Pollution degree	3		

ACCESSORIES	Type	Part No.	Std. Pack
End plate	AP WT 4 D1/2	07.313.2955.0	10
Partition	TW WT 4 E	07.313.2855.0	10
Cross connector	2-pole	IVB WKF 4-2	10
	5-pole	IVB WKF 4-5	10
	10-pole	IVB WKF 4-10	10

# MULTI-TIER BLOCKS WITH SCREW CONNECTION

## WKN 2,5 E / U

- Multi-tier block for mounting on TS 35 and TS 32
- Nominal cross section 2.5 mm<sup>2</sup>
- Ex e I/II  II 2GD IM2  
Follow the EX installation instructions on page 174
- Class I, Zone 1, AEx, e, II, T6

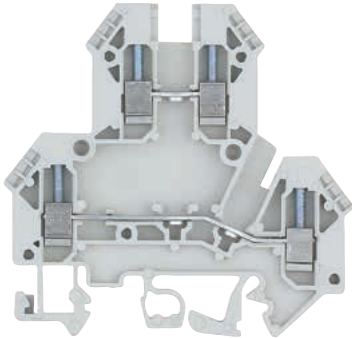

Description	Type	Part No.	Std. Pack
Multi-tier block	gray WKN 2,5 E/U	57.403.7055.0	100
GENERAL DATA			
Width / length / height, incl. TS 7.5	5 mm / 66 mm / 64 mm		
Wire strip length	8 mm		
Approvals			
TECHNICAL DATA			
	IEC	UL	CSA
	EN 60 947-7-1		
Cross section fine-stranded	0.14 – 2.5 mm <sup>2</sup>		
Cross section solid/stranded	0.2 – 4 mm <sup>2</sup>		
Cross section, AWG	22 – 12	24 – 12	
Rated current	24 A	20 A	25 A
Rated voltage	500 V	600 V	600 V
Rated impulse voltage	6 A		
Pollution degree	3		

## WKN 2,5 E / U / VB

- Multi-tier block, vertically jumpered, with screw connection for mounting on TS 35 and TS 32
- Nominal cross section 2.5 mm<sup>2</sup>
- Ex e I/II  II 2GD IM2  
Follow the EX installation instructions on page 174
- Class I, Zone 1, AEx, e, II, T6

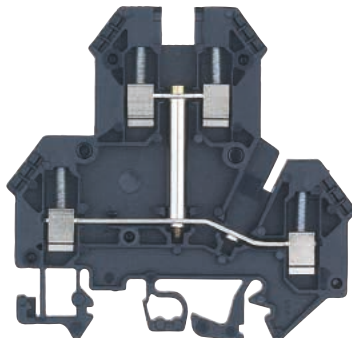

Description	Type	Part No.	Std. Pack
Multi-tier block	black WKN 2,5 E/U/VB	57.403.6955.1	100
GENERAL DATA			
Width / length / height, incl. TS 7.5	5 mm / 66 mm / 64 mm		
Wire strip length	8 mm		
Approvals			
TECHNICAL DATA			
	IEC	UL	CSA
	EN 60 947-7-1		
Cross section fine-stranded	0.14 – 2.5 mm <sup>2</sup>		
Cross section solid/stranded	0.2 – 4 mm <sup>2</sup>		
Cross section, AWG	22 – 12	24 – 12	
Rated current	24 A	20 A	25 A
Rated voltage	500 V	600 V	600 V
Rated impulse voltage	6 A		
Pollution degree	3		

## ACCESSORIES FOR SELOS WKN 2,5 E/U...

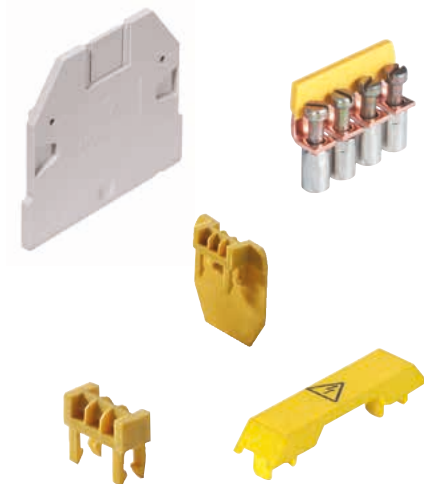

ACCESSORIES	Type	Part No.	Std. Pack
End plate	gray APN 2,5 E	07.312.1755.0	10
Partition	gray TWN 2,5 E	07.312.1855.0	10
Cross connector with screws, insulated	2-pole IVB WK 2,5 - 2	Z7.280.2227.0	10
	3-pole IVB WK 2,5 - 3	Z7.280.2327.0	10
	up to 12-pole IVB WK 2,5 - 12	Z7.280.3227.0	10
Partition plate with marking facility	yellow TS 2,5 GELB	07.311.2053.8	10
Single cover with marking facility	yellow AD VB 2,5 GELB	04.326.2053.8	10
Cover with warning symbol over 4 blocks		04.343.4756.8	10



### WT 4 E

- Multi-tier block for mounting on TS 35
- Nominal cross section 4 mm<sup>2</sup>
- II 2G 2D Ex eb IIC  
EN 60079-0:12+A11:13 / IEC 60079-0:2011 Ed:6.0  
EN 60079-7:07 / IEC 60079-7:2006-07 Ed:4  
Follow the EX installation instructions on page 174
- Connection capacity: 2 wires, equal size  
0.14 – 2.5 mm<sup>2</sup>

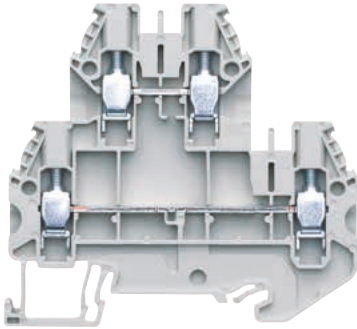

Description	Type	Part No.	Std. Pack
Multi-tier block	gray WT 4 E	58.504.7055.0	100
Multi-tier block	blue WT 4 E BL	58.504.7055.6	100

#### GENERAL DATA

Width / length / height, incl. TS 7.5	6 mm / 72 mm / 67 mm		
Wire strip length	9 mm		IEC Ex SEV 14.0004 U
Approvals			SEV 14 ATEX 0124 U

TECHNICAL DATA	IEC	UL	CSA	
	EN 60 947-7-1			
Cross section fine-stranded	0.14 – 6 mm <sup>2</sup>			0.14 – 6 mm <sup>2</sup>
Cross section solid/stranded	0.14 – 6 mm <sup>2</sup>			0.14 – 6 mm <sup>2</sup>
Cross section, AWG		26 – 10	26 – 10	
Rated current	32 A	30 A	30 A	32 A
Rated voltage	800 V	300 V	300 V	550 V
Rated impulse voltage	8 kV			
Pollution degree	3			

ACCESSORIES	Type	Part No.	Std. Pack
End plate	AP WT 4 E	07.313.3355.0	10
Partition	TW WT 4 E	07.313.2855.0	10
Cross connector	2-pole IVB WKF 4-2	Z7.261.1227.0	10
	3-pole IVB WKF 4-3	Z7.261.1327.0	10
	4-pole IVB WKF 4-4	Z7.261.1427.0	10
	5-pole IVB WKF 4-5	Z7.261.1527.0	10
	10-pole IVB WKF 4-10	Z7.261.2027.0	10

### WT 4 E VB

- Multi-tier block, vertically jumpered, with screw connection for mounting on TS 35
- Nominal cross section 4 mm<sup>2</sup>
- II 2G 2D Ex eb IIC  
EN 60079-0:12+A11:13 / IEC 60079-0:2011 Ed:6.0  
EN 60079-7:07 / IEC 60079-7:2006-07 Ed:4  
Follow the EX installation instructions on page 174
- Connection capacity: 2 wires, equal size  
0.14 – 2.5 mm<sup>2</sup>

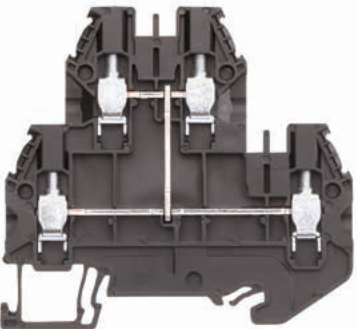

Description	Type	Part No.	Std. Pack
Multi-tier block	black WT 4 E VB	58.504.6955.1	100

#### GENERAL DATA

Width / length / height, incl. TS 7.5	6 mm / 72 mm / 67 mm		
Wire strip length	9 mm		IEC Ex SEV 14.0004 U
Approvals			SEV 14 ATEX 0124 U

TECHNICAL DATA	IEC	UL	CSA	
	EN 60 947-7-1			
Cross section fine-stranded	0.14 – 6 mm <sup>2</sup>			0.14 – 6 mm <sup>2</sup>
Cross section solid/stranded	0.14 – 6 mm <sup>2</sup>			0.14 – 6 mm <sup>2</sup>
Cross section, AWG		26 – 10	26 – 10	
Rated current	32 A	30 A	30 A	32 A
Rated voltage	800 V	300 V	300 V	550 V
Rated impulse voltage	8 kV			
Pollution degree	3			

ACCESSORIES	Type	Part No.	Std. Pack
End plate	AP WT 4 E	07.313.3355.0	10
Partition	TW WT 4 E	07.313.2855.0	10
Cross connector	2-pole IVB WKF 4-2	Z7.261.1227.0	10
	3-pole IVB WKF 4-3	Z7.261.1327.0	10
	4-pole IVB WKF 4-4	Z7.261.1427.0	10
	5-pole IVB WKF 4-5	Z7.261.1527.0	10
	10-pole IVB WKF 4-10	Z7.261.2027.0	10

### WT 4 E PE

- Multi-tier ground block with screw connection for mounting on TS 35
- Nominal cross section 4 mm<sup>2</sup>
- II 2G 2D Ex eb IIC  
EN 60079-0:12+A11:13 / IEC 60079-0:2011 Ed:6.0  
EN 60079-7:07 / IEC 60079-7:2006-07 Ed:4  
Follow the EX installation instructions on page 174
- Connection capacity: 2 wires, equal size  
0.14 – 2.5 mm<sup>2</sup>

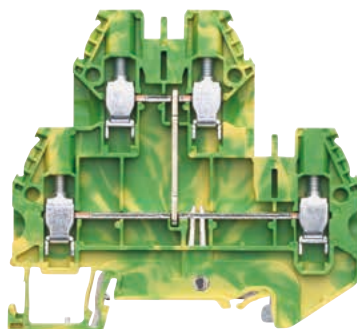

Description	Type	Part No.	Std. Pack
Multi-tier ground block	green/yellow WT 4 E PE	58.504.9255.0	100

#### GENERAL DATA

Width / length / height, incl. TS 7.5	6 mm / 72 mm / 67 mm		
Wire strip length	9 mm		IEC Ex SEV 14.0004 U
Approvals			SEV 14 ATEX 0124 U

TECHNICAL DATA	IEC	UL	CSA	
	EN 60 947-7-2			
Cross section fine-stranded	0.14 – 6 mm <sup>2</sup>			0.14 – 6 mm <sup>2</sup>
Cross section solid/stranded	0.14 – 6 mm <sup>2</sup>			0.14 – 6 mm <sup>2</sup>
Cross section, AWG		26 – 10		
Rated current				
Rated voltage	800 V		300 V	
Rated impulse voltage	8 kV			
Pollution degree	3			

ACCESSORIES	Type	Part No.	Std. Pack
End plate	AP WT 4 E	07.313.3355.0	10

# SPECIALTY FUNCTION BLOCKS WITH SCREW CONNECTION

## WT 4 E...

- Function block with screw connection for mounting on TS 35
- Nominal cross section 4 mm<sup>2</sup>
- Connection capacity: 2 wires, equal size 0.14 – 2.5 mm<sup>2</sup>

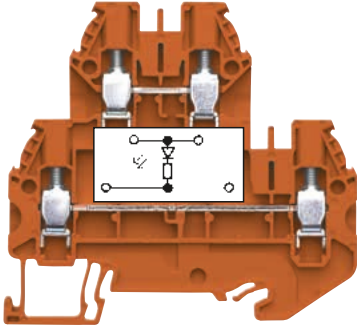

Description	Type	Part No.	Std. Pack
Function block	orange WT 4 E...	58.504.XX55.9	100
<b>GENERAL DATA</b>			
Width / length / height, incl. TS 7.5	6 mm / 72 mm / 67 mm		
Wire strip length	9 mm		
Approvals			
<b>TECHNICAL DATA</b>			
	<b>IEC</b>	<b>UL</b>	<b>CSA</b>
	EN 60 947-7-1/-2		
Cross section fine-stranded	0.14 – 6 mm <sup>2</sup>		
Cross section solid/stranded	0.14 – 6 mm <sup>2</sup>		
Cross section, AWG	26 – 10		26 – 10
Rated current			
Rated voltage			
Rated impulse voltage			
Pollution degree			
<b>ACCESSORIES</b>			
	<b>Type</b>	<b>Part No.</b>	<b>Std. Pack</b>
End plate	gray AP WT 4 E	07.313.3355.0	10

## EXAMPLES OF FUNCTIONS

The multi-tier block is available on request as a function block for a wide variety of switching tasks.

58.504.8355.9

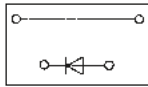

400 V  
1 A/1000 V

58.504.8055.9  
with inverted diode

58.504.7455.9 LED red

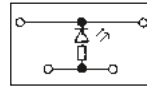

24 V DC  
R = 4,7 K  
0,4 W

58.504.8255.9

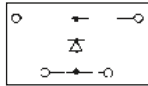

400 V  
1 A/1000 V

58.504.8155.9  
with inverted diode

58.504.7955.9

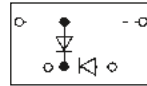

1 A/400 V

58.504.8855.9  
with inverted diodes

58.504.7255.9 LED red

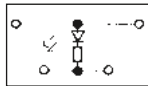

24 V DC  
R = 4,7 K  
0,4 W

58.504.8755.9 LED green

58.504.7355.9

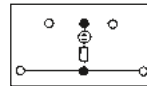

U = 100-500 V

# THREE-TIER-/ INITIATOR BLOCKS WITH SCREW CONNECTION

## WK 2,5-3 D/U

- Multi-tier block for mounting on TS 35 and TS 32
- Nominal cross section 2,5 mm<sup>2</sup>

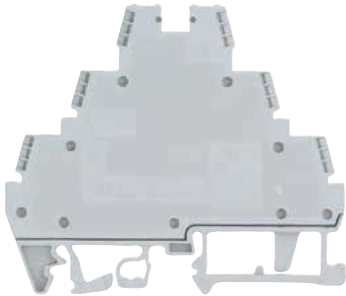

WK 2,5 - 3 D/U-NGN

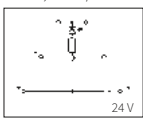

WK 2,5 - 3 D/U-PGN

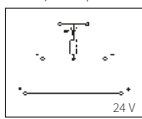

Description	Type	Part No.	Std. Pack
Multi-tier block	gray WK 2,5 - 3 D/U	57.503.8855.0	50
Multi-tier bl., LED (green) betw. signal and +	WK 2,5 - 3 D/U-NGN	57.503.8955.0	50
Multi-tier bl., LED (green) betw. signal and -	WK 2,5 - 3 D/U-PGN	57.503.9055.0	50

GENERAL DATA			
Width / length / height, incl. TS 7.5	6 mm / 79 mm / 69 mm		
Wire strip length	7 mm		
Approvals			

TECHNICAL DATA	IEC	UL	CSA
	EN 60 947-7-1		
Cross section fine-stranded	0.5 – 2.5 mm <sup>2</sup>		
Cross section solid/stranded	0.5 – 4 mm <sup>2</sup>		
Cross section, AWG		22 – 12	22 – 12
Rated current	24 A	25 A	25 A
Rated voltage	400 V*	300 V*	300 V*
Rated impulse voltage	6 kV		
Pollution degree	3		

ACCESSORIES	Type	Part No.	Std. Pack
Partition	gray TW 2,5 - 3 D/U	07.312.1255.0	50

## WK 2,5-3 D/SL

- Multi-tier block for mounting on TS 35
- Nominal cross section 2,5 mm<sup>2</sup>

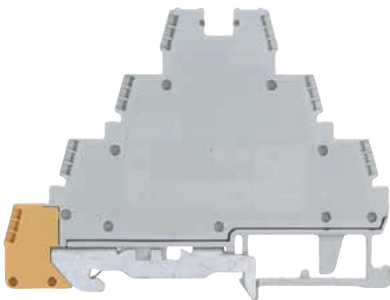

WK 2,5 - 3 D SL-NGN

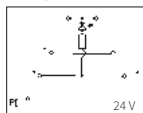

WK 2,5 - 3 D SL-PGN

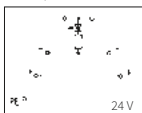

Description	Type	Part No.	Std. Pack
Multi-tier block	gray WK 2,5 - 3 D SL	56.503.8355.0	50
Multi-tier bl., LED (green) betw. signal and +	WK 2,5 - 3 D SL-NGN	56.503.8455.0	50
Multi-tier bl., LED (green) betw. signal and -	WK 2,5 - 3 D SL-PGN	56.503.8555.0	50

GENERAL DATA			
Width / length / height, incl. TS 7.5	6 mm / 79 mm / 69 mm		
Wire strip length	7 mm		
Approvals			

TECHNICAL DATA	IEC	UL	CSA
	EN 60 947-7-1		
Cross section fine-stranded	0.5 – 2.5 mm <sup>2</sup>		
Cross section solid/stranded	0.5 – 4 mm <sup>2</sup>		
Cross section, AWG		22 – 12	22 – 12
Rated current	24 A	25 A	25 A
Rated voltage	400 V*	300 V*	300 V*
Rated impulse voltage	6 kV		
Pollution degree	3		

ACCESSORIES	Type	Part No.	Std. Pack
Partition	gray TW 2,5 - 3 D/U	07.312.1255.0	50

## ACCESSORIES FOR SELOS WK 2,5-3 D/...

- The use of cross connectors (jumper combs), requires partitions in order to maintain the air and creepage distances.
- 24 V<sub>DC</sub> with LED

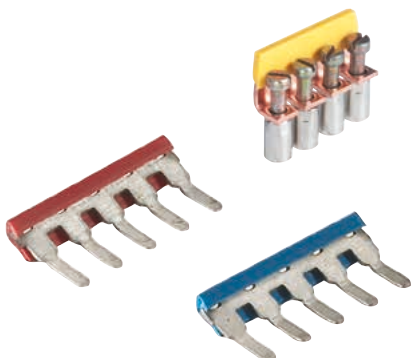

ACCESSORIES	Type	Part No.	Std. Pack	
Cross connector with screws, insulated, for upper level	2-pole	IVB WK/3D-02	Z7.270.0227.0	10
	3-pole	IVB WK/3D-03	Z7.270.0327.0	10
	up to 12-pole	IVB WK/3D-12	Z7.270.1227.0	10
Jumper comb, angled, insulated (red), for lower level	2-pole	IVB WK 2,5-K-2 ROT	Z7.267.0227.5	10
	3-pole	IVB WK 2,5-K-3 ROT	Z7.267.0327.5	10
	up to 12-pole	IVB WK 2,5-K-12 ROT	Z7.267.1227.5	10
Jumper comb, angled, insulated (blue), for lower level	2-pole	IVB WK 2,5-K-2 BLAU	Z7.267.0227.6	10
	3-pole	IVB WK 2,5-K-3 BLAU	Z7.267.0327.6	10
	up to 12-pole	IVB WK 2,5-K-12 BLAU	Z7.267.1227.6	10

# INITIATOR BLOCKS WITH SCREW CONNECTION

## WK 2,5-4 KI / U

- Initiator block with screw connection for mounting on TS 35 and TS 32
- Nominal cross section 2.5 mm<sup>2</sup>

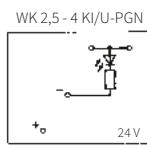
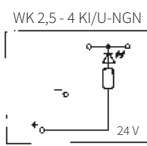
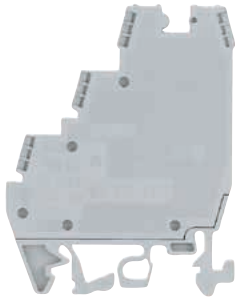

Description	Type	Part No.	Std. Pack
Initiator block	gray WK 2,5 - 4 KI/U	57.503.7855.0	100
Multi-tier bl., LED (green) betw. signal and +	WK 2,5 - 4 KI/U-NGN	57.503.7955.0	100
Multi-tier bl., LED (green) betw. signal and -	WK 2,5 - 4 KI/U-PGN	57.503.8055.0	100

GENERAL DATA			
Width / length / height, incl. TS 7.5	6 mm / 53 mm / 69 mm		
Wire strip length	7 mm		
Approvals			

TECHNICAL DATA			
	IEC	UL	CSA
	EN 60 947-7-1		
	DIN VDE 0611 T1		
Cross section fine-stranded	0.5 - 2.5 mm <sup>2</sup>		
Cross section solid/stranded	0.5 - 4 mm <sup>2</sup>		
Cross section, AWG		22 - 12	22 - 12
Rated current	24 A	25 A	25 A
Rated voltage	250 V*	300 V*	300 V*
Rated impulse voltage	4 kV		
Pollution degree	3		

ACCESSORIES			
Partition	gray TW 2,5 - 4 K/U	07.312.0555.0	10

## WK 2,5-4 KI / SL

- Initiator block with screw connection for mounting on TS 35
- Nominal cross section 2.5 mm<sup>2</sup>

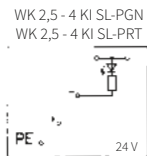
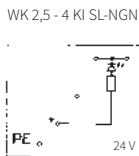
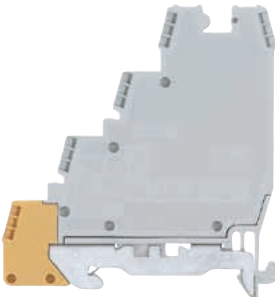

Description	Type	Part No.	Std. Pack
Initiator block	gray WK 2,5 - 4 KI SL	56.503.7355.0	100
Multi-tier bl., LED (green) betw. signal and +	WK 2,5 - 4 KI SL-NGN	56.503.7455.0	100
Multi-tier bl., LED (green) betw. signal and -	WK 2,5 - 4 KI SL-PGN	56.503.7555.0	100
Multi-tier bl., LED (red) betw. signal and -	WK 2,5 - 4 KI SL-PRT	56.503.7655.0	100

GENERAL DATA			
Width / length / height, incl. TS 7.5	6 mm / 64 mm / 69 mm		
Wire strip length	7 mm		
Approvals			

TECHNICAL DATA			
	IEC	UL	CSA
	EN 60 947-7-1		
	DIN VDE 0611 T1		
Cross section fine-stranded	0.5 - 2.5 mm <sup>2</sup>		
Cross section solid/stranded	0.5 - 4 mm <sup>2</sup>		
Cross section, AWG		22 - 12	22 - 12
Rated current	24 A	25 A	25 A
Rated voltage	250 V*	300 V*	300 V*
Rated impulse voltage	4 kV		
Pollution degree	3		

ACCESSORIES			
Partition	gray TW 2,5 - 4 K/U	07.312.0555.0	10

# ACCESSORIES FOR SELOS WK 2,5-4 KI/...

- The use of cross connectors (jumper combs), requires partitions in order to maintain the air and creepage distances.
- 24 V<sub>AC</sub> with LED



ACCESSORIES				
Cross connector with screws, insulated, for upper level	2-pole	IVB WK/3D-02	Z7.270.0227.0	10
	3-pole	IVB WK/3D-03	Z7.270.0327.0	10
	up to 12-pole	IVB WK/3D-12	Z7.270.1227.0	10
Jumper comb, angled, insulated (red), for lower level	2-pole	IVB WK 2,5-K-2 ROT	Z7.267.0227.5	10
	3-pole	IVB WK 2,5-K-3 ROT	Z7.267.0327.5	10
	up to 12-pole	IVB WK 2,5-K-12 ROT	Z7.267.1227.5	10
Jumper comb, angled, insulated (blue), for lower level	2-pole	IVB WK 2,5-K-2 BLAU	Z7.267.0227.6	10
	3-pole	IVB WK 2,5-K-3 BLAU	Z7.267.0327.6	10
	up to 12-pole	IVB WK 2,5-K-12 BLAU	Z7.267.1227.6	10

## WK 2,5-4 KOI / U

- Initiator block with screw connection for mounting on TS 35 and TS 32
- Nominal cross section 2.5 mm<sup>2</sup>

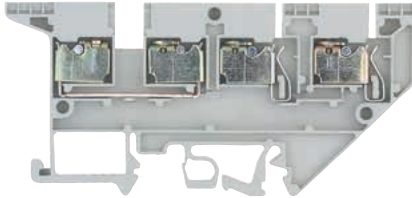

Description	Type	Part No.	Std. Pack
Initiator block	gray WK 2,5-4 KOI/U	57.503.7055.0	50

### GENERAL DATA

Width / length / height, incl. TS 7.5	5 mm / 92 mm / 45 mm
Wire strip length	10 mm
Approvals	

### TECHNICAL DATA

IEC	UL	CSA
EN 60 947-7-1		
Cross section fine-stranded	0.5 – 2.5 mm <sup>2</sup>	
Cross section solid/stranded	0.5 – 4 mm <sup>2</sup>	
Cross section, AWG	22 – 12	22 – 12
Rated current, feed-through	16 A	20/30 A
Rated voltage	400 V	300 V
Rated impulse voltage	6 kV	300 V
Pollution degree	3	

### ACCESSORIES

Description	Type	Part No.	Std. Pack
Cross connector with screws, for signal feed through	2-pole VB WK 2,5-2	Z7.280.0227.0	10
	3-pole VB WK 2,5-3	Z7.280.0327.0	10
	up to 6-pole VB WK 2,5-6	Z7.280.0627.0	10

## WK 2,5-4 KOI / U-NGN

## WK 2,5-4 KOI / U-PGN

- Initiator block with screw connection for mounting on TS 35 and TS 32
- **NGN:** With LED (green) between signal and plus
- **PGN:** Wit LED (green) between signal and minus
- Nominal cross section 2.5 mm<sup>2</sup>

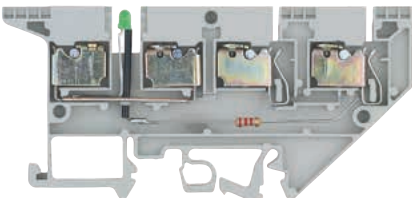

### DESCRIPTION

Description	Type	Part No.	Std. Pack
Initiator block	gray WK 2,5-4 KOI/U-NGN	57.503.7155.0	50
Initiator block	gray WK 2,5-4 KOI/U-PGN	57.503.7255.0	50

### GENERAL DATA

Width / length / height, incl. TS 7.5	5 mm / 92 mm / 45 mm
Wire strip length	10 mm
Approvals	

### TECHNICAL DATA

IEC	UL	CSA
EN 60 947-7-1		
Cross section fine-stranded	0.5 – 2.5 mm <sup>2</sup>	
Cross section solid/stranded	0.5 – 4 mm <sup>2</sup>	
Cross section, AWG	22 – 12	22 – 12
Rated current, feed-through	16 A	20/30 A
Rated voltage	24 DC	24 V
Rated impulse voltage	24 V	24 V
Pollution degree		



**NGN:** Indicator: R = 2.2 K 0,35 W  
Lamp color: green

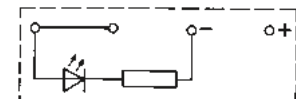

**PGN:** Indicator: R = 2.2 K 0,35 W  
Lamp color: green

## ACCESSORIES FOR SELOS WK 2,5-4 KOI/U...



### ACCESSORIES

Description	Type	Part No.	Std. Pack
End plate	gray AP 2,5-4 KO	07.310.9355.0	50
Partition	gray TW 2,5-4 KO	07.310.9455.0	50
Cross connector for voltage supply	2-pole VB WK 2,5 KO-2	07.257.0227.0	100
	3-pole VB WK 2,5 KO-3	07.257.0327.0	100
	up to 20-pole VB WK 2,5 KO-20	07.257.2027.0	50
Partition plate with marking facility	yellow TS 2,5 GELB	07.311.2053.8	10
Single cover with marking facility	yellow AD VB 2,5 GELB	04.326.2053.8	10
Cover strip for cross connectors over 10 blocks	AD VB 5/10	04.342.0556.0	10
Tear-off marking strip, red, marked "+"	red 9705 A/5/10 B + ROT	04.855.0253.5	25
Tear-off marking strip, blue, marked "-"	blue 9705 A/5/10 B - BLAU	04.855.0353.6	25

# FUSE BLOCKS WITH SCREW CONNECTION

## WK 4 TKG... WITH THSI 5X20

- Disconnect base block with screw connection for mounting on TS 35 and TS 32
- Nominal cross section 4 mm<sup>2</sup>

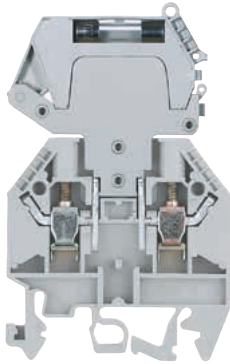

Description	Type	Part No.	Std. Pack
Disconnect base block	gray WK 4 TKG/U	57.504.4055.0	100
Fuse disconnect lever	gray THSI 5x20	Z1.298.1053.0	10
Fuse disconnect lever with LED 12 - 24 V <sup>2)</sup>	THSI 5x20 LED24	Z1.298.1153.0	10
Fuse disconnect lever with LED 24 - 60 V <sup>2)</sup>	THSI 5x20 LED60	Z1.298.1253.0	10
Fuse disconnect lever with GL 110 - 250 V <sup>2)</sup>	THSI 5x20 GL250	Z1.298.1353.0	10

GENERAL DATA			
Width / length / height, incl. TS 7.5	6 mm / 48 mm / 81 mm		
Wire strip length	9 mm		
Approvals			
TECHNICAL DATA			
	IEC	UL	CSA
	EN 60947-7-1, EN 60127-6		
Cross section fine-stranded	0.5 - 4 mm <sup>2</sup>		
Cross section solid/stranded	0.5 - 6 mm <sup>2</sup>		
Cross section, AWG		22 - 10	20 - 10
Rated current	<sup>1)</sup>	10 A <sup>1)</sup>	6.3 A <sup>1)</sup>
Rated voltage	690 V <sup>2)</sup>	300 V <sup>2)</sup>	250 V <sup>2)</sup>
Rated impulse voltage	6 kV		
Pollution degree	3		

## WK 4 TKG... WITH THSI 6,3X32

- Disconnect base block with screw connection for mounting on TS 35 and TS 32
- Nominal cross section 4 mm<sup>2</sup>

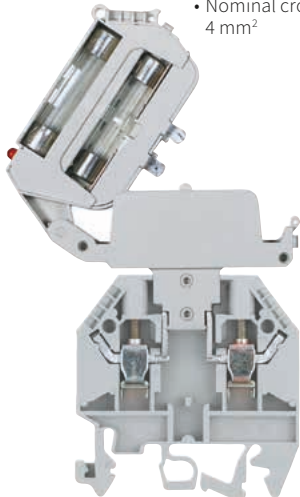

Description	Type	Part No.	Std. Pack
Disconnect base block	gray WK 4 TKG/U	57.504.4055.0	100
Fuse disconnect lever	gray THSI 6,3x32	Z1.298.1653.0	10
Fuse disconnect lever with LED 12 - 24 V <sup>2)</sup>	THSI 6,3x32 LED24	Z1.298.1753.0	10
Fuse disconnect lever with LED 24 - 60 V <sup>2)</sup>	THSI 6,3x32 LED60	Z1.298.1853.0	10
Fuse disconnect lever with GL 110 - 250 V <sup>2)</sup>	THSI 6,3x32 GL250	Z1.298.1953.0	10

GENERAL DATA			
Width / length / height, incl. TS 7.5	6 mm / 48 mm / 81 mm		
Width disconnect lever THSI 6.3x32	8 mm	use end plate 07.311.6155.0 to maintain pitch	
Wire strip length	9 mm		
Approvals			
TECHNICAL DATA			
	IEC	UL	CSA
	EN 60947-7-1, EN 60127-6		
Cross section fine-stranded	0.5 - 4 mm <sup>2</sup>		
Cross section solid/stranded	0.5 - 6 mm <sup>2</sup>		
Cross section, AWG		22 - 10	20 - 10
Rated current	<sup>1)</sup>	10 A <sup>1)</sup>	6.3 A <sup>1)</sup>
Rated voltage	690 V <sup>2)</sup>	300 V <sup>2)</sup>	250 V <sup>2)</sup>
Rated impulse voltage	6 kV		
Pollution degree	3		

## TECHNICAL INFORMATION:

<sup>1)</sup> When selecting G fuse inserts, make sure that the specified maximum power loss is not exceeded. The current is determined by the inserted fuse.

Maximum power loss at 23°C ambient temperature (according to DIN EN 60947-7-3)

Type	Rated Voltage	Overload protection		Exclusive short-circuit protection	
		Single arrangement	Group arrangement	Single arrangement	Group arrangement
THSI 5x20	250V	2.5W	1.6W	4.0W	2.5W
THSI 6,3x32	500V	2.5W	1.6W	4.0W	4.0W
SIST	250V	2.5W	1.6W	2.5W	2.5W

<sup>2)</sup> The voltage range is determined by the built-in LED display.

Depending on the application and the installation method, the possibility of increased temperature must be checked in the closed fuse holders.

Higher ambient temperatures mean additional stress for the fuse inserts. Therefore, the reduction of the rated current must be considered accordingly in these applications.

Indicator (24V):	Lamp color: red Power consumption: 10.3 mA
Indicator (220V):	Lamp color: red Power consumption: 0.3 mA



### WK 4 TKG... SIST

- Disconnect base block with screw connection for mounting on TS 35 and TS 32
- Nominal cross section 4 mm<sup>2</sup>

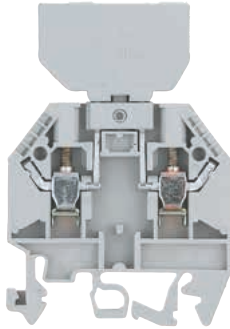

Description	Type	Part No.	Std. Pack
Disconnect base block	gray WK 4 TKG/U	57.504.4055.0	100
Fuse holder for 5x20 fuse	Si ST	Z1.299.4055.0	10
Fuse holder with LED 24-60V	Si ST LED	Z1.299.4155.0	10
Fuse holder with GL 220V	Si ST GL	Z1.299.4255.0	10

GENERAL DATA				
Width / length / height, incl. TS 7.5	6 mm / 48 mm / 68 mm			
Wire strip length	9 mm			
Approvals				
TECHNICAL DATA		IEC	UL	CSA
		EN 60947-7-1, EN 60 127-6		
Cross section fine-stranded	0.5 – 4 mm <sup>2</sup>			
Cross section solid/stranded	0.5 – 6 mm <sup>2</sup>			
Cross section, AWG		22 – 10	20 – 10	
Rated current	1)	10 A	6.3 A <sup>1)</sup>	
Rated voltage	690 V <sup>2)</sup>	300 V	250 V	
Rated impulse voltage	6 kV			
Pollution degree	3			

### WK 4 TKG... DIST

- Disconnect base block with screw connection for mounting on TS 35 and TS 32
- Nominal cross section 4 mm<sup>2</sup>

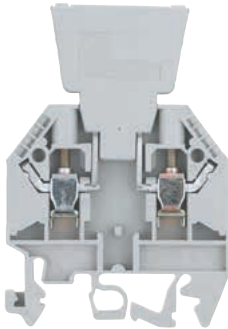

Description	Type	Part No.	Std. Pack
Disconnect base block	gray WK 4 TKG/U	57.504.4055.0	100
Diode plug - without contacts	DIST ...	Z1.299.3055.0	10
Diode plug - diode	I <sub>max</sub> = 1 A DIST-1 N 4007-1 <sup>3)</sup>	Z1.299.3155.0	10
Diode plug - diode	I <sub>max</sub> = 1 A DIST-1 N 4007-2 <sup>4)</sup>	Z1.299.3355.0	10
Diode plug with jumper	I <sub>max</sub> = 10 A DIST-D	Z1.299.3255.0	10

GENERAL DATA				
Width / length / height, incl. TS 7.5	6 mm / 48 mm / 68 mm			
Wire strip length	9 mm			
Approvals				
TECHNICAL DATA		IEC	UL	CSA
		EN 60947-7-1, EN 60 127-6		
Cross section fine-stranded	0.5 – 4 mm <sup>2</sup>			
Cross section solid/stranded	0.5 – 6 mm <sup>2</sup>			
Cross section, AWG		22 – 10	20 – 10	
Rated current		10 A	6.3 A <sup>1)</sup>	
Rated voltage	690 V <sup>2)</sup>	300 V	250 V	
Rated impulse voltage	6 kV			
Pollution degree	3			

The current carrying load depends on the component used.  
 Temporary peak voltage 1000 V.  
 Pole assignment of the diode: Anode Cathode<sup>3)</sup>  
 Cathode Anode<sup>4)</sup>

## ACCESSORIES FOR SELOS WK 4 TKG... WITH THSI 5..., SIST... AND DIST...

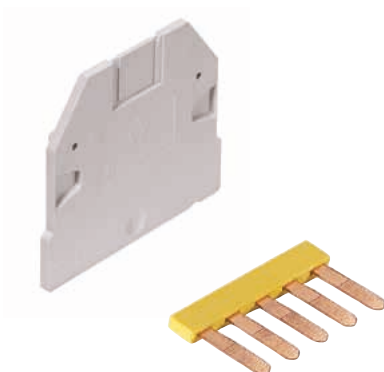

ACCESSORIES	Type	Part No.	Std. Pack
End plate	gray AP 4 TK	07.311.6155.0	10
Partition	gray TW 4 TK	07.311.8155.0	10
Jumper comb, insulated	2-pole IVB 1 WK 4..-2	Z7.255.4227.0	10
	3-pole IVB 1 WK 4..-3	Z7.255.4327.0	10
	up to 6-pole IVB 1 WK 4..-6	Z7.255.4627.0	10

# FUSE- AND KNIFE EDGE DISCONNECT BLOCKS WITH SCREW CONNECTION

## WK 4/SI-D/U 5X25

- Fuse block with screw connection for mounting on TS 35 and TS 32
- Nominal cross section 4 mm<sup>2</sup>

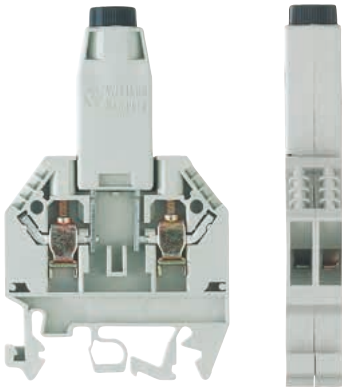

Description	Type	Part No.	Std. Pack
Fuse block	gray		
w. G-screw cap B DIN 41674, 5x25 mm	WK 4/SI-D/U 5 x 25	57.504.1655.0	50
w. G-SG-screw cap A DIN 41674, 5x20 mm	WK 4/SI-D/U 5 x 20	57.504.1755.0	50

GENERAL DATA			
Width / length / height, incl. TS 7.5	12 mm / 48 mm / 49 mm		
Wire strip length	9 mm		
Approvals			

TECHNICAL DATA	IEC	UL	CSA
	EN 60947-7-1, EN 60127-6		
Cross section fine-stranded	0.5 – 4 mm <sup>2</sup>		
Cross section solid/stranded	0.5 – 6 mm <sup>2</sup>		
Cross section, AWG		22 – 10	
Rated current	6.3 A		10 A
Rated voltage	690 V		250 V
Rated impulse voltage	6 kV		
Pollution degree	3		

## WK 4/TKM

- Knife edge disconnect block with screw connection for mounting on TS 35 and TS 32
- Nominal cross section 4 mm<sup>2</sup>
- **Version with test bolt:** CSA: 300V  
EN 60947-7-1 – 400V/4kV/3  
Test bolt can be loaded with 1A

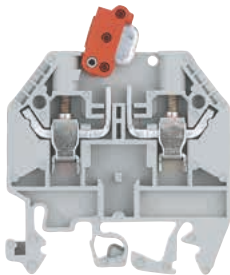

Description	Type	Part No.	Std. Pack
Knife edge disconnect block	gray WK 4/TKM/U	57.504.2055.0	100
Knife edge disconnect block with 2 test bolts	blue WK 4/TKM/U BLAU gray WK 4/TKM/P3/U	57.504.2055.6 57.504.2355.0	100 100

GENERAL DATA			
Width / length / height, incl. TS 7.5	6 mm / 48 mm / 49 mm		
Wire strip length	9 mm		
Approvals			

TECHNICAL DATA	IEC	UL	CSA
	EN 60947-7-1, EN 60127-6		
Cross section fine-stranded	0.5 – 4 mm <sup>2</sup>		
Cross section solid/stranded	0.5 – 6 mm <sup>2</sup>		
Cross section, AWG		22 – 10	22 – 10
Rated current	20 A	20 A	20 A
Rated voltage	690 V	600 V	600 V
Rated impulse voltage	6 kV		
Pollution degree	3		

## WK 4 TKG-TRST/U

- Invertible plug disconnect block with screw connection for mounting on TS 35 and 42
- Nominal cross section 4 mm<sup>2</sup>
- **Version with test bolt:** CSA: 300V  
EN 60 947-7-1 – 400V/4kV/3  
Test bolt can be loaded with 1A

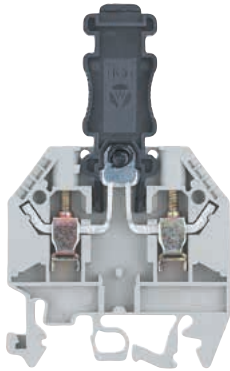

Description	Type	Part No.	Std. Pack
Invertible plug disconnect block with 2 test bolts, gray	gray WK 4 TKG-TRST/U WK 4 TKG-TRST P3/U	57.504.4555.0 57.504.4855.0	100 100
GENERAL DATA			
Width / length / height, incl. TS 7.5	6 mm / 48 mm / 78 mm		
Wire strip length	9 mm		
Approvals			
TECHNICAL DATA			
	IEC	UL	CSA
	EN 60 947-7-1, EN 60 127-6		
Cross section fine-stranded	0.5 – 4 mm <sup>2</sup>		
Cross section solid/stranded	0.5 – 6 mm <sup>2</sup>		
Cross section, AWG		22 – 10	22 – 10
Rated current	20 A	10 A	20 A
Rated voltage	690 V	300 V	600 V
Rated impulse voltage	6 kV		
Pollution degree	3		

## WK 4 TKS D/U

- Feed-through block with screw connection for mounting on TS 35 and TS 32
- Nominal cross section 4 mm<sup>2</sup>
- Same dimensions as types WK 4 TKG / U and types WK 4 /TKM/U

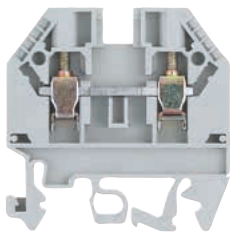

Description	Type	Part No.	Std. Pack
Feed-through block	gray WK 4 TKS D/U	57.504.4455.0	100
GENERAL DATA			
Width / length / height, incl. TS 7.5	6 mm / 48 mm / 49 mm		
Wire strip length	9 mm		
Approvals			
TECHNICAL DATA			
	IEC	UL	CSA
	EN 60 947-7-1, EN 60 127-6		
Cross section fine-stranded	0.5 – 4 mm <sup>2</sup>		
Cross section solid/stranded	0.5 – 6 mm <sup>2</sup>		
Cross section, AWG		22 – 10	20 – 10
Rated current	32 A	25 A	20 A
Rated voltage	690 V	300 V	600 V
Rated impulse voltage	6 kV		
Pollution degree	3		

## ACCESSORIES FOR SELOS WK 4...

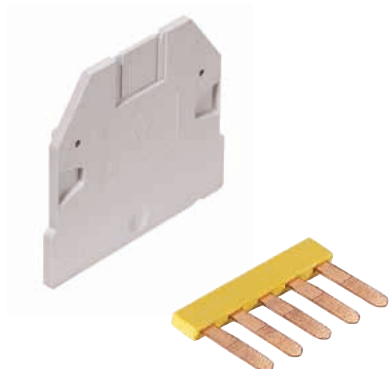

ACCESSORIES	Type	Part No.	Std. Pack
End plate	gray AP 4 TK	07.311.6155.0	10
Partition	gray TW 4 TK	07.311.8155.0	10
Jumper comb, insulated	2-pole	IVB 1 WK 4..-2	10
	3-pole	IVB 1 WK 4..-3	10
	up to 6-pole	IVB 1 WK 4..-6	10

# FUSE BLOCKS WITH SCREW CONNECTION

## WK 4 THSi 5... /U

- Integrated lever-action fuse block with screw connection for mounting on TS 35 and TS 32
- Nominal cross section 4 mm<sup>2</sup>
- For 5 mm miniature fuses
- The standard block has a storage location for a replacement fuse.

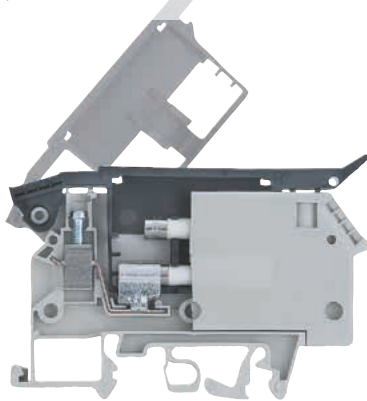

Description	Type	Part No.	Std. Pack
Fuse block	gray WK 4/THSi 5 ... U	57.904.5355.0	50
- with LED 5-12V~/s current consumed.	2.3-7mA WK 4/THSi 5 LED 12 U	57.904.5455.0	50
- with LED 12-24V~/s current con.	2.8-6.2mA WK 4/THSi 5 LED 24 U	57.904.5555.0	50
- with LED 24-60V~/s current con.	1.5-4mA WK 4/THSi 5 LED 60 U	57.904.5655.0	50
- with GL 110-250V~/s current con.	0.13-0.55mA WK 4/THSi 5 GL 250 U	57.904.5755.0	50
- with GL 380-500V~/s current con.	0.2-0.3mA WK 4/THSi 5 GL 500 U	57.904.5855.0	50

GENERAL DATA				
Width / length / height, incl. TS 7.5	8 mm / 77 mm / 54 mm			
Wire strip length	8 mm			
Approvals				
TECHNICAL DATA		IEC	UL	CSA
		EN 60947-7-1, EN 60127-6		
Cross section fine-stranded	0,5 – 4 mm <sup>2</sup>			
Cross section solid/stranded	0,5 – 6 mm <sup>2</sup>			
Cross section, AWG	22 – 10		22 – 10	
Rated current	6.3 A <sup>1)</sup>	15 A	6.3 A	
Rated voltage	800 V <sup>2)</sup>	600 V <sup>2)</sup>	600 V <sup>2)</sup>	
Rated impulse voltage	8 kV			
Pollution degree	3			

## WK 4 THSi 6,3... /U

- Integrated lever-action fuse block with screw connection for mounting on TS 35 and TS32
- Nominal cross section 4 mm<sup>2</sup>
- For 6.3 mm miniature fuses
- The standard block has a storage location for a replacement fuse.

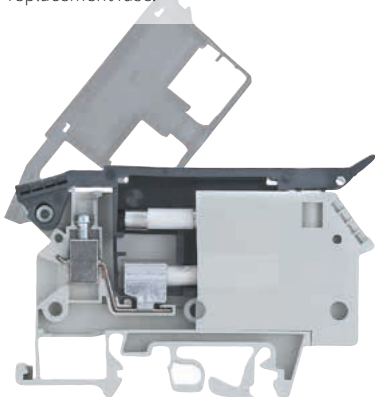

Description	Type	Part No.	Std. Pack
Fuse block	gray WK 4/THSi 6,3 ... U	57.904.6355.0	50
- with LED 5-12V~/s current consumed.	2.3-7mA WK 4/THSi 6,3 LED 12 U	57.904.6455.0	50
- with LED 12-24V~/s current con.	2.8-6.2mA WK 4/THSi 6,3 LED 24 U	57.904.6555.0	50
- with LED 24-60V~/s current con.	1.5-4mA WK 4/THSi 6,3 LED 60 U	57.904.6655.0	50
- with GL 110-250V~/s current con.	0.13-0.55mA WK 4/THSi 6,3 GL 250 U	57.904.6755.0	50
- with GL 380-500V~/s current con.	0.2-0.3mA WK 4/THSi 6,3 GL 500 U	57.904.6855.0	50

GENERAL DATA				
Width / length / height, incl. TS 7.5	10 mm / 77 mm / 54 mm			
Wire strip length	8 mm			
Approvals				
TECHNICAL DATA		IEC	UL	CSA
		EN 60947-7-1, EN 60127-6		
Cross section fine-stranded	0,5 – 4 mm <sup>2</sup>			
Cross section solid/stranded	0,5 – 6 mm <sup>2</sup>			
Cross section, AWG	22 – 10		22 – 10	
Rated current	10 A <sup>1)</sup>	15 A	10 A	
Rated voltage	800 V <sup>2)</sup>	600 V <sup>2)</sup>	600 V <sup>2)</sup>	
Rated impulse voltage	8 kV			
Pollution degree	3			

# TECHNICAL INFORMATION FOR SELOS WK 4 THSi...

The fuse blocks of this type have a flip top disconnect lever. It accepts miniature fuses of 5x20, 5x25 and 5x30 mm (terminal width: 8 mm) or 6.3x32 mm (terminal width: 10 mm). The hinged lever has latch points both in the open and in the closed position, and can be sealed.

All terminal blocks are available in two different versions, i.e. with or without red LEDs functioning as indicators.

<sup>1)</sup> When selecting G fuse inserts, make sure that the specified maximum power loss is not exceeded. The current is determined by the inserted fuse.

<sup>2)</sup> The voltage range is determined by the built-in LED display.

Depending on the application and the installation method, the circumstances for increased temperature must be checked in the closed fuse holders. Higher ambient temperatures are an additional load for the fuse inserts. Therefore, the reduction of the rated current must be considered accordingly in these applications.

<sup>1)</sup> Maximum power loss at 23°C ambient temperature (according to DIN EN 60947-7-3)

Type	Rated voltage	Overload protection		Exclusive short-circuit protection	
		Single arrangement	Group arrangement	Single arrangement	Group arrangement
THSi 5x20/25	250V	1.6W	1.6W	4.0W	2.5W
THSi 6,3x32	500V	2.5W	2.5W	4.0W	2.5W
THSi 5x30	500V	1.6W	1.6W	4.0W	2.5W

## WK 10/SI .../U

- Fuse block with screw cap for mounting on TS 35
- Nominal cross section 10 mm<sup>2</sup>
- \* Voltage and current are determined by the built-in LED and the inserted G-fuse.

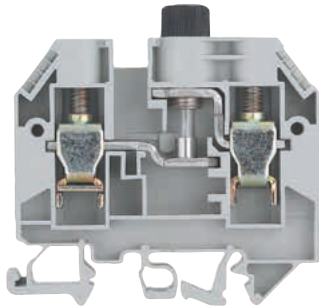

Description	Type	Part No.	Std. Pack
Fuse block, with screw cap	gray		
- A DIN 41674 for G-fuses DIN 41571	WK 10/Si U 5 x 20	57.910.5055.0	50
- B DIN 41674 for G-fuses DIN 41576	WK 10/Si U 5 x 25	57.910.5155.0	50
- A DIN 41674 for G-fuses	WK 10/Si U 5 x 30	57.910.5255.0	50
- with screw cap for G-fuses	WK 10/Si U 6,3 x 32	57.910.5355.0	50

GENERAL DATA			
Width / length / height, incl. TS 7.5	12 mm / 65 mm / 58 mm		
Wire strip length	13 mm		
Approvals			
TECHNICAL DATA			
	IEC	UL	CSA
	EN 60947-7-1, EN 60127-6		
Cross section fine-stranded	1.0 – 10 mm <sup>2</sup>		
Cross section solid/stranded	1.0 – 16 mm <sup>2</sup>		
Cross section, AWG		22 – 6	16 – 6
Rated current	max. 10 A <sup>1)</sup>	15 A	max. 15 A
Rated voltage	500 V*	600 V*	600 V*
	* 57.910.5055.0 250 V~	600 V	600 V
	* 57.910.5155.0 250 V~	600 V	600 V
	* 57.910.5255.0 500 V~	600 V	600 V
	* 57.910.5355.0 500 V~	600 V	600 V
Rated impulse voltage	6 kV		
Pollution degree	3		

## WK 10/SI .../U WITH INDICATOR

- Fuse block with screw cap for mounting on TS 35 and TS 32
- Nominal cross section 10 mm<sup>2</sup>
- With indicator
- \* Voltage and current are determined by the built-in indicator and the inserted G-fuse.

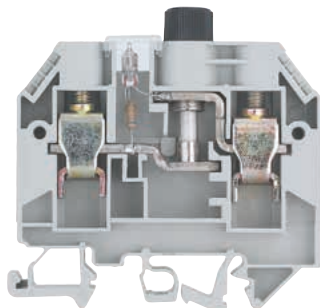

Description	Type	Part No.	Std. Pack
Fuse block, with screw cap	gray		
- A DIN 41674 for G-fuses DIN 41571	WK 10/Si U 5 x 20M, NGL	57.910.5455.0	50
- B DIN 41674 for G-fuses DIN 41576	WK 10/Si U 5 x 20M, GLB	57.910.5855.0	50
- A DIN 41674 for G-fuses	WK 10/Si U 6,3 x 32M, NGL	57.910.5755.0	50
- with screw cap for G-fuses	WK 10/Si U 6,3 x 32M, GLB	57.910.6155.0	50

GENERAL DATA			
Width / length / height, incl. TS 7.5	12 mm / 65 mm / 58 mm		
Wire strip length	13 mm		
Approvals			
TECHNICAL DATA			
	IEC	UL	CSA
	EN 60947-7-1, EN 60127-6		
Cross section fine-stranded	1.0 – 10 mm <sup>2</sup>		
Cross section solid/stranded	1.0 – 16 mm <sup>2</sup>		
Cross section, AWG		22 – 6	16 – 6
Rated current	max. 10 A <sup>1)</sup>	15 A	max. 15 A
Rated voltage	500 V*	600 V*	600 V*
Indicator – Current consumed			
red – 0.16 - 0.8 mA	* 57.910.5455.0 110 - 250V~	150 V	500 V
yellow – 24 mA	* 57.910.5855.0 28V~	28 V	28 V
red – 0.16 - 0.8 mA	* 57.910.5755.0 110 - 500V~	150 V	500 V
yellow – 24 mA	* 57.910.6155.0 28V~	28 V	28 V
Rated impulse voltage	6 kV		
Pollution degree	3		

## ACCESSORIES AND INFO FOR SELOS WK 10/SI...



ACCESSORIES	Type	Part No.	Std. Pack
End plate	gray AP 10/Si	07.311.4155.0	10
Cross connector with screws	2-pole VB WK 10/Si-2	27.287.0227.0	10
	3-pole VB WK 10/Si-3	27.287.0327.0	10
	up to 6-pole VB WK 10/Si-6	27.287.0627.0	10
Transparent block cover (for 1 block)		04.312.2056.0	100

<sup>1)</sup> Maximum power loss at 23° C ambient temperature (according to DIN EN 60947-7-3)

Type	Overload protection		Exclusive short-circuit protection	
	Single arrangement	Group arrangement	Single arrangement	Group arrangement
WK 10 Si U 5x20	4.0W/10A	2.5W/6.3A	4.0W/10A	4.0W/6.3A
WK 10 Si U 6.3x32	4.0W/10A	2.5W/2.5A	4.0W/10A	2.5W/2.5A
WK 10 Si U 5x25	4.0W/10A	2.5W/6.3A	4.0W/10A	4.0W/6.3A
WK 10 Si U 5x30	4.0W/10A	2.5W/6.3A	4.0W/10A	4.0W/6.3A

# FEED-THROUGH BLOCKS WITH WIECON PLUGGABLE CONNECTION

FOR PC BOARD TERMINAL TYPE 8113 B, TYPE 8313 B, TYPE 8113 B/VL, TYPE 8113 B/VR, TYPE 8113 B/TOP

## WK 2,5 U/D/8113 S/V

- Feed-through block with screw connection for mounting on TS 35 and TS 32
- Nominal cross section 2,5 mm<sup>2</sup>

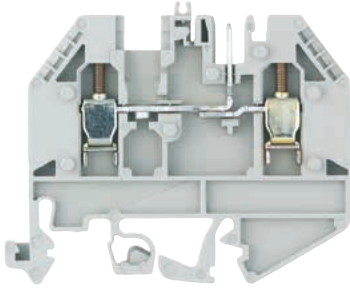

Description	Type	Part No.	Std. Pack
Feed-through block	gray WK 2,5 U/D/8113 S/V...	57.503.2155.0	50
Power block	blue WK 2,5 U/D/8113 S/V/VK	57.503.2555.6	50
Feed-through block, with LED 25V	gray WK 2,5 U/D/8113 S/V/LED 25	57.503.2255.0	50
Feed-through block, with LED 50V	gray WK 2,5 U/D/8113 S/V/LED 50	57.503.2355.0	50

GENERAL DATA			
Width / length / height, incl. TS 7.5	5 mm / 61 mm / 51 mm		
Wire strip length	9 mm		
Approvals	UL ®		

TECHNICAL DATA	IEC	UL	CSA
	EN 60947-7-1		
Cross section fine-stranded	0.5 – 2,5 mm <sup>2</sup>		
Cross section solid/stranded	0.5 – 4 mm <sup>2</sup>		
Cross section, AWG		22 – 12	24 – 12
Rated current	12 A	15 A	15 A
Rated voltage	250 V	300 V	300 V
Rated impulse voltage	4 kV		
Pollution degree	3		

ACCESSORIES	Type	Part No.	Std. Pack
End plate	gray AP 2,5 U/D/8113 S/V	07.311.9055.0	10
Spacer*	2.5 mm thick ZP 2,5 U/D/8113 S/V	07.311.9155.0	10
Cover strip for LED, transparent	10-pole AD VB 5/10 P	04.342.3556.8	10
Coding strip		05.561.0053.0	100

\* for wiecon PC board connector with 7.5 mm pitch

## WK 2,5 U/8113 S/V

- Feed-through block with screw connection for mounting on TS 35 and TS 32
- Nominal cross section 2,5 mm<sup>2</sup>

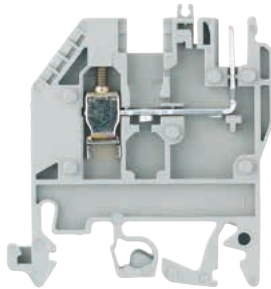

Description	Type	Part No.	Std. Pack
Feed-through block	gray WK 2,5 U/8113 S/V...	57.503.2655.0	50
Power block	blue WK 2,5 U/8113 S/V/VK	57.503.3055.6	50
Feed-through block, with LED 25V	gray WK 2,5 U/8113 S/V/LED 25	57.503.2755.0	50
Feed-through block, with LED 50V	gray WK 2,5 U/8113 S/V/LED 50	57.503.2855.0	50

GENERAL DATA			
Width / length / height, incl. TS 7.5	5 mm / 44 mm / 51 mm		
Wire strip length	9 mm		
Approvals	UL ®		

TECHNICAL DATA	IEC	UL	CSA
	EN 60947-7-1		
Cross section fine-stranded	0.5 – 2,5 mm <sup>2</sup>		
Cross section solid/stranded	0.5 – 4 mm <sup>2</sup>		
Cross section, AWG		22 – 12	24 – 12
Rated current	12 A	15 A	15 A
Rated voltage	250 V	300 V	300 V
Rated impulse voltage	4 kV		
Pollution degree	3		

ACCESSORIES	Type	Part No.	Std. Pack
End plate	gray AP 2,5 U/8113 S/V	07.312.1555.0	10
Spacer*	2.5 mm thick ZP 2,5 U/8113 S/V	07.312.1655.0	10
Coding strip		05.561.0053.0	100

\* for wiecon PC board connector with 7.5 mm pitch

## WK 2,5 U/D/8113 S/H

- Feed-through block with screw connection for mounting on TS 35 and TS 32
- Nominal cross section 2,5 mm<sup>2</sup>

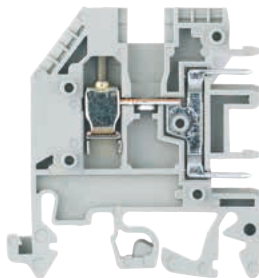

Description	Type	Part No.	Std. Pack
Feed-through block	gray WK 2,5 U/8113 S/H	57.503.2055.0	100

GENERAL DATA			
Width / length / height, incl. TS 7.5	5 mm / 44 mm / 48 mm		
Wire strip length	9 mm		
Approvals	UL ®		

TECHNICAL DATA	IEC	UL	CSA
	EN 60947-7-1		
Cross section fine-stranded	0.5 – 2,5 mm <sup>2</sup>		
Cross section solid/stranded	0.5 – 4 mm <sup>2</sup>		
Cross section, AWG		22 – 12	24 – 12
Rated current	12 A	20 A	15 A
Rated voltage	250 V	300 V	300 V
Rated impulse voltage	4 kV		
Pollution degree	3		

ACCESSORIES	Type	Part No.	Std. Pack
End plate	gray AP 2,5 U/8113 S/H	07.311.9855.0	10
Coding strip		05.584.0053.0	100
Locking piece	10-pole	05.576.5853.0	25



### TYPE 8113 B/..., 8313 B/...

- Mating orientation parallel to wire entry
- For additional pluggable blocks, see wiecon product family



Description	Type	Part No.	Std. Pack
<b>Spacing 5.00 mm, Rated voltage 250 V</b>			
unmarked, starting at 2	8113 B/2 OB	25.320.3253.0	100
up to 16	8113 B/16 OB	25.320.4653.0	50
marked with 1- x, starting at 2	8113 B/2	25.320.0253.0	100
up to 16	8113 B/16	25.320.1653.0	50
<b>Spacing 7.50 mm, Rated voltage 400 V</b>			
unmarked, starting at 2	8313 B/2 OB	25.360.3253.0	100
up to 12	8313 B/12 OB	25.360.4253.0	50
marked with 1- x, starting at 2	8313 B/2	25.360.0253.0	100
up to 12	8313 B/12	25.360.1253.0	50
<b>GENERAL DATA</b>			
Approvals			
<b>TECHNICAL DATA</b>			
	<b>IEC</b>	<b>UL</b>	<b>CSA</b>
	EN 60947-7-1		
Cross section fine-stranded	0.5 – 2.5 mm <sup>2</sup>		
Cross section solid/stranded	0.5 – 4 mm <sup>2</sup>		
Cross section, AWG		22 – 12	24 – 12
Rated current	12 A	15 A	15 A
Rated voltage	250 V	300 V	300 V
Rated impulse voltage	400 V		
Pollution degree			
<b>ACCESSORIES</b>			
	<b>Type</b>	<b>Part No.</b>	<b>Std. Pack</b>
Coding strip		05.561.9153.0	100

### TYPE 8113 B/... VR

- Mating orientation 90° towards the wire
- For additional pluggable blocks, see wiecon product family

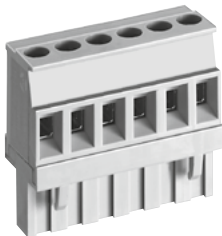

Description	Type	Part No.	Std. Pack
<b>Spacing 5.00 mm, Rated voltage 250 V</b>			
unmarked, starting at 2	8113 B/2 VR OB	25.325.3253.0	100
up to 16	8113 B/16 VR OB	25.325.4653.0	50
marked with 1- x, starting at 2	8113 B/2	25.325.0253.0	100
up to 16	8113 B/16	25.325.1653.0	50
<b>GENERAL DATA</b>			
Approvals			
<b>TECHNICAL DATA</b>			
	<b>IEC</b>	<b>UL</b>	<b>CSA</b>
	EN 60947-7-1		
Cross section fine-stranded	0.5 – 2.5 mm <sup>2</sup>		
Cross section solid/stranded	0.5 – 4 mm <sup>2</sup>		
Cross section, AWG		22 – 12	24 – 12
Rated current	12 A	15 A	15 A
Rated voltage	250 V	300 V	300 V
Rated impulse voltage	400 V		
Pollution degree			
<b>ACCESSORIES</b>			
	<b>Type</b>	<b>Part No.</b>	<b>Std. Pack</b>
Coding strip		05.561.9153.0	100

## ACCESSORIES FOR SELOS WK 2,5 U/...



ACCESSORIES	Type	Part No.	Std. Pack
Cross connector with screws, insulated	2-pole	VB WK 2,5-2	27.280.2227.0
	3-pole	IVB WK 2,5-3	27.280.2327.0
	12-pole	IVB WK 2,5-12	27.280.3227.0
Partition plate with marking facility	yellow	TS 2,5 GELB	07.311.2053.8
Single cover with marking facility	yellow	AD VB 2,5 GELB	04.326.2053.8
Cover strip for PCB terminal	24-pole		04.343.9056.8
	with warning symbol		04.343.9156.8
Connection rail	L=0,4 m		05.561.4125.0
for connection to power block (blue) and indicator			

# DISTRIBUTION BLOCKS WITH SCREW / PUSH-ON CONNECTION

## WK/4-8 S/IW/U

- Feed-through block with push-on connection for mounting on TS 35
- Push-on connectors 2.8 x 0.8 acc. to DIN 46247  
Push-on connectors 6.3 x 0.8 acc. to DIN 46247
- Current carrying capability according to DIN 46249  
Tab connector 2.8 10A  
6.3 20A

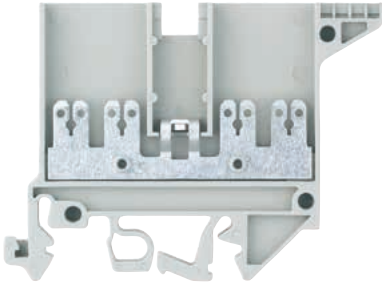

Description	Type	Part No.	Std. Pack
Feed-through block	gray WK/4-8 S/IW/U	57.504.6355.0	100

GENERAL DATA				
Width / length / height, incl. TS 7.5	6 mm / 67 mm / 50 mm			
Wire strip length				
Approvals				
TECHNICAL DATA		IEC	UL	CSA
		EN 60947-7-1, EN 61210		
Cross section fine-stranded				
Cross section solid/stranded				
Cross section, AWG		22 – 12	22 – 12	
Rated current	20 A	10 A	10 A	
Rated voltage	800 V <sup>(1)</sup>	600 V <sup>(1)</sup>	300 V <sup>(1)</sup>	
Rated impulse voltage	8 kV			
Pollution degree	3			

ACCESSORIES		Type	Part No.	Std. Pack
End plate	gray	AP 3 S/IW	07.311.4355.0	50
Cross connector with screws	2-pole	VB WK/...S/IW/U-2	Z7.281.3227.0	10
	3-pole	VB WK/...S/IW/U-3	Z7.281.3327.0	10
	up to 6-pole	VB WK/...S/IW/U-6	Z7.281.3627.0	10

## WK/4-8 S/U

- Feed-through block with push-on connection for mounting on TS 35
- Push-on connectors 2.8 x 0.8 acc. to DIN 46247  
Push-on connectors 6.3 x 0.8 acc. to DIN 46247
- Current carrying capability according to DIN 46249  
Tab connector 2.8 10A  
6.3 20A

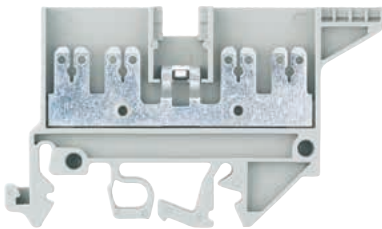

Description	Type	Part No.	Std. Pack
Feed-through block	gray WK/4-8 S/U	57.504.6255.0	100

GENERAL DATA				
Width / length / height, incl. TS 7.5	6 mm / 67 mm / 40 mm			
Wire strip length				
Approvals				
TECHNICAL DATA		IEC	UL	CSA
		EN 60947-7-1, EN 61210		
Cross section fine-stranded				
Cross section solid/stranded				
Cross section, AWG		22 – 12	22 – 12	
Rated current	20 A	10 A	10 A	
Rated voltage	800 V <sup>(1)</sup>	300 V <sup>(1)</sup>	300 V <sup>(1)</sup>	
Rated impulse voltage	8 kV			
Pollution degree	3			

ACCESSORIES		Type	Part No.	Std. Pack
End plate	gray	AP 4 S	07.311.4255.0	10
Cross connector with screws	2-pole	9703/6-2	Z7.211.0227.0	50
	3-pole	9703/6-3	Z7.211.0327.0	50
	up to 6-pole	9703/6-6	Z7.211.0627.0	50

## WK/3-6 S KO/U

- Feed-through block with push-on connection for mounting on TS 35
- Nominal cross section 4,0 mm<sup>2</sup>
- Push-on connectors 2.8 x 0.8 acc. to DIN 46247  
Push-on connectors 6.3 x 0.8 acc. to DIN 46247
- Current carrying capability according to DIN 46249  
Tab connector 2.8 10A  
6.3 20A

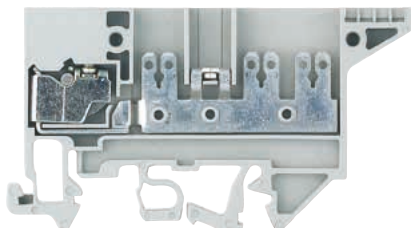

Description	Type	Part No.	Std. Pack
Feed-through block	gray WK/3-6 S KO/U	57.504.7355.0	100

GENERAL DATA				
Width / length / height, incl. TS 7.5	6 mm / 72 mm / 40 mm			
Wire strip length	9 mm			
Approvals				
TECHNICAL DATA		IEC	UL	CSA
For use with insulating sleeves		EN 60947-7-1, EN 61210		
Cross section fine-stranded	0.5 – 4 mm <sup>2</sup>			
Cross section solid/stranded	0.5 – 4 mm <sup>2</sup>			
Cross section, AWG		22 – 12	22 – 12	
Rated current	20 A	10 A	10 A	
Rated voltage	690 V <sup>(1)</sup>	300 V <sup>(1)</sup>	300 V <sup>(1)</sup>	
Rated impulse voltage	8 kV			
Pollution degree	3			

ACCESSORIES		Type	Part No.	Std. Pack
End plate	gray	9701 A/6 1 S KO TP 2	07.310.5855.0	10
Cross connector with screws	2-pole	2072/2	Z7.220.0227.0	50
	3-pole	2072/2	Z7.220.0227.0	50
	up to 6-pole	2072/6	Z7.220.0627.0	50

### WK 4 3-6 S 1 K/U

- Feed-through block with push-on connection for mounting on TS 35
- Nominal cross section 4 mm<sup>2</sup>
- Push-on connectors 2.8 x 0.8 acc. to DIN 46247
- Push-on connectors 6.3 x 0.8 acc. to DIN 46247
- Current carrying capability according to DIN 46249
 

Tab connector	2.8	10 A
6.3	20 A	

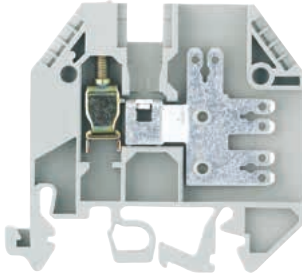

Description	Type	Part No.	Std. Pack
Feed-through block	gray WK 4 3-6 S 1 K/U	57.504.3755.0	100

#### GENERAL DATA

Width / length / height, incl. TS 7.5	6 mm / 52 mm / 48 mm
Wire strip length	9 mm
Approvals	

#### TECHNICAL DATA

	IEC	UL	CSA
	EN 60947-7-1, EN 61210		
Cross section fine-stranded	0.5 – 4 mm <sup>2</sup>		
Cross section solid/stranded	0.5 – 6 mm <sup>2</sup>		
Cross section, AWG		22 – 12	22 – 12
Rated current	20 A	10 A	10 A
Rated voltage	800 V <sup>1)</sup>	300 V <sup>1)</sup>	300 V <sup>1)</sup>
Rated impulse voltage	8 kV		
Pollution degree	3		

#### ACCESSORIES

Description	Type	Part No.	Std. Pack
End plate	gray AP4 3 S 1 K	07.311.3855.0	10
Cross connector with screws	2-pole	IVB WK 4-2	10
	3-pole	IVB WK 4-3	10
	up to 12-pole	IVB WK 4-12	10

### WK/5-10 S/U

- Feed-through block with push-on connection for mounting on TS 35
- Push-on connectors 2.8 x 0.8 acc. to DIN 46247
- Push-on connectors 6.3 x 0.8 acc. to DIN 46247
- Current carrying capability according to DIN 46249
 

Tab connector	2.8	10 A
6.3	20 A	

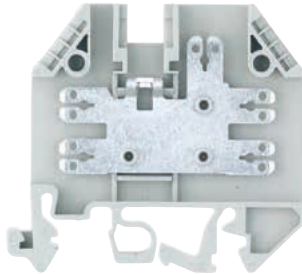

Description	Type	Part No.	Std. Pack
Feed-through block	gray WK/5-10 S/U	57.504.3655.0	100

#### GENERAL DATA

Width / length / height, incl. TS 7.5	6 mm / 52 mm / 48 mm
Wire strip length	
Approvals	

#### TECHNICAL DATA

	IEC	UL	CSA
	EN 60947-7-1, EN 61210		
Cross section fine-stranded			
Cross section solid/stranded			
Cross section, AWG		22 – 12	
Rated current	20 A	10 A	10 A
Rated voltage	800 V <sup>1)</sup>	300 V <sup>1)</sup>	300 V <sup>1)</sup>
Rated impulse voltage	8 kV		
Pollution degree	3		

#### ACCESSORIES

Description	Type	Part No.	Std. Pack
End plate	gray AP 5 S	07.311.4655.0	10
Cross connector with screws	2-pole	IVB WKI 4-2	10
	3-pole	IVB WKI 4-3	10
	up to 12-pole	IVB WKI 4-12	10

## ACCESSORIES FOR SELOS WK/...



#### ACCESSORIES

Description	Type	Part No.	Std. Pack
Partition plate with marking facility	yellow TS 4 GELB	07.311.2153.8	10
Single cover with marking facility	yellow AD VB 4 GELB	04.326.2153.8	10
Insulating sleeve for tab connector			

<sup>1)</sup> Rating for use with insulating sleeves

# FUNCTION BLOCKS WITH SCREW CONNECTION

## 9786 U/12

- Function block with screw connection for mounting on TS 35 and TS 32
- Nominal cross section 2.5 mm<sup>2</sup>

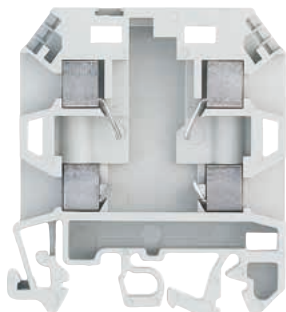

Description	Type	Part No.	Std. Pack
Function block empty	9786 U/12	57.904.2055.0	50
with bridge rectifier B380 C1500	9786 U/12 G4	57.904.2555.0	50
with optocoupler CNY 17 / 3	9786 U/12 OPK	57.904.2855.0	50

GENERAL DATA			
Width / length / height, incl. TS 7.5	12 mm / 52 mm / 58 mm		
Wire strip length	9 mm		
Approvals			

TECHNICAL DATA	IEC	UL	CSA
	EN 60947-7-1		
Cross section fine-stranded	0.5 – 2.5 mm <sup>2</sup>		
Cross section solid/stranded	0.5 – 2.5 mm <sup>2</sup>		
Cross section, AWG			
Rated current	24 A	22 – 14	22 – 14
Rated voltage	800 V	6 A	6 A
Rated impulse voltage	8 kV	300 V	300 V
Pollution degree	3		

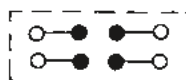

## 9785 U/... - SPT

- Compensating terminal with screw connection for mounting on TS 35 and TS 32
- Nominal cross section 2.5 mm<sup>2</sup>

Resistor range: 0.25 Ω up to 100 Ω  
 Resistor tolerance: ± 10%  
 Resistor range: 100 Ω up to 50 kΩ  
 Resistor tolerance: ± 20%  
 Limite continuous resistance value:  
 0.75 W up to 70° C  
 Max. load: 100 mA  
 Temperature coefficient: 0 up to +500 ppm/°C  
 Max. operating voltage: 300V

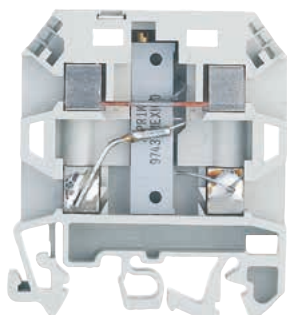

Description	Type	Part No.	Std. Pack	
Compensating terminal with potentiometer	gray 10 Ω	9785 U/10 Ω	57.904.0055.0	50
	20 Ω	9785 U/20 Ω	57.904.0155.0	50
	50 Ω	9785 U/50 Ω	57.904.0255.0	50
	100 Ω	9785 U/100 Ω	57.904.0355.0	50
	200 Ω	9785 U/200 Ω	57.904.0455.0	50
	510 Ω	9785 U/500 Ω	57.904.0555.0	50
	1 kΩ	9785 U/1 kΩ	57.904.0655.0	50
	2 kΩ	9785 U/2 kΩ	57.904.0755.0	50
	5 kΩ	9785 U/5 kΩ	57.904.0855.0	50
	10 kΩ	9785 U/10 kΩ	57.904.0955.0	50
Compensating terminal with potentiometer as voltage divider	gray 10 Ω	9785 U/10 Ω-SPT	57.904.3955.0	50
	20 Ω	9785 U/20 Ω-SPT	57.904.4155.0	50
	50 Ω	9785 U/50 Ω-SPT	57.904.4255.0	50
	100 Ω	9785 U/100 Ω-SPT	57.904.4355.0	50
	200 Ω	9785 U/200 Ω-SPT	57.904.4455.0	50
	510 Ω	9785 U/500 Ω-SPT	57.904.4555.0	50
	1 kΩ	9785 U/1 kΩ-SPT	57.904.4655.0	50
	2 kΩ	9785 U/2 kΩ-SPT	57.904.4755.0	50
	5 kΩ	9785 U/5 kΩ-SPT	57.904.4855.0	50
	10 kΩ	9785 U/10 kΩ-SPT	57.904.4955.0	50
20 kΩ	9785 U/20 kΩ-SPT	57.904.5055.0	50	
50 kΩ	9785 U/50 kΩ-SPT	57.904.5155.0	50	

GENERAL/TECHNICAL DATA			
Width / length / height, incl. TS 7.5	12 mm / 49 mm / 58 mm		
Wire strip length	9 mm		
Approvals			
EN 60947-7-1			
Cross section fine-stranded	0.5 – 2.5 mm <sup>2</sup>		
Cross section solid/stranded	0.5 – 2.5 mm <sup>2</sup>		

## 9786 U/TSK...

- Thermocouple terminal with screw connection for mounting on TS 35 and TS 32
- Nominal cross section 2,5 mm<sup>2</sup>

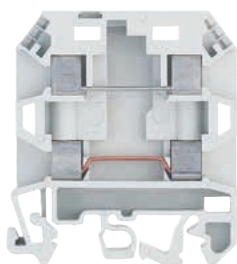

Description	Type	Part No.	Std. Pack
Thermocouple terminal type T-Cu / CuNi 44	9786 U/TSK Cu-CuNi	57.904.7355.0	50
Thermocouple terminal type E-NiCr / CuNi 44	9786 U/TSK NiCr-CuNi	57.904.7055.0	50
Thermocouple terminal type J-Fe / CuNi 44	9786 U/TSK Fe-CuNi	57.904.7155.0	50
Thermocouple terminal type K-NiCr / Ni	9786 U/TSK NiCr-Ni	57.904.7255.0	50
Thermocouple terminal type R-PtRh 13 / Pt	9786 U/TSK E-Cu-A-Cu	57.904.7455.0	50

GENERAL DATA			
Width / length / height, incl. TS 7.5	12 mm / 52 mm / 58 mm		
Wire strip length	9 mm		
Approvals			

TECHNICAL DATA	IEC	UL	CSA
	EN 60947-7-1		
Cross section fine-stranded	0.5 – 2.5 mm <sup>2</sup>		
Cross section solid/stranded	0.5 – 2.5 mm <sup>2</sup>		
Rated voltage	800 V		
Rated impulse voltage	8 kV		
Pollution degree	3		

Example:  
 Fe/constantan      Fe / CuNi 44  
 fully enclosed design

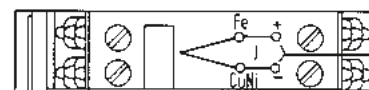

## 9786 U/12

- Ground disconnect with screw connection for mounting on TS 35 and TS 32
- Nominal cross section 6 mm<sup>2</sup>



Description	Type	Part No.	Std. Pack
Ground disconnect 24-48V $\cong$ with LED	9760 U/8 TKE 48	57.110.1655.0	25
110-220V $\cong$ with indicator lamp	9760 U/8 TKE 220	57.110.1555.0	25

### GENERAL DATA

Width / length / height, incl. TS 7.5 17,5 mm / 71 mm / 52 mm

Wire strip length 9 mm

Approvals

### TECHNICAL DATA

IEC EN 60947-7-1

Cross section fine-stranded 1.0 – 10 mm<sup>2</sup>

Cross section solid/stranded 1.0 – 10 mm<sup>2</sup>

Cross section, AWG

18 – 8 18 – 8

Rated current

25 A 25 A

Rated voltage 24 – 48 V / 110 – 220 V

48 V / 220 V 48 V / 220 V

Rated impulse voltage

Pollution degree

## EN 60204 part 1 / DIN VDE 0113 part 1 “Fitting industrial machines with electrical equipment”

### 9.4.3.1. Ground faults.

Ground faults in any control circuits must not result in unintentional startup, potentially hazardous motions or shutdown of the machine.

During normal operation the auxiliary circuit is connected to the functional ground and the green (24 - 48V) or yellow (110 - 220V) status display is illuminated.

If a low resistance ground fault occurs, the line fuse will blow.

Once the contact separator is open, you can replace the fuse.

The illumination of the red lamp alone indicates an ground fault.

After the fault had been rectified, the green (24 - 48V) or yellow (110 - 220V) display will also light up. The contacts should now be moved to the “on” position as a result of which the red lamp will go out.

The illumination of the yellow or green lamp and external display indicates that the auxiliary circuit has been reconnected to the functional ground.

### Ground Disconnect terminal with LED 24 - 48V $\cong$

Normal operation

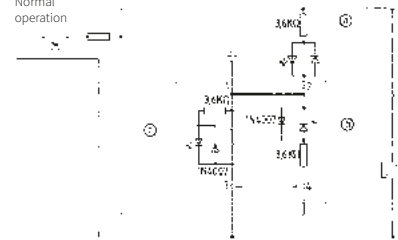

- (a) external status display lights up
- (b) green status display lights up
- (c) red ground-fault indicator lights up

Ground fault

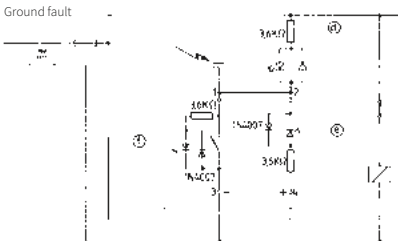

- (d) external status display lights up
- (e) green status display lights up
- (f) red ground-fault indicator lights up

### Ground Disconnect terminal with Neon Lamp 110 - 220V $\cong$

Normal operation

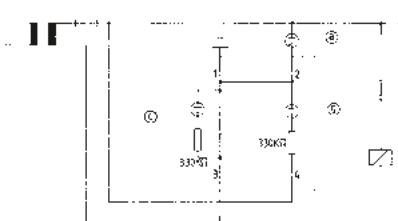

- (g) yellow status display lights up

Ground fault

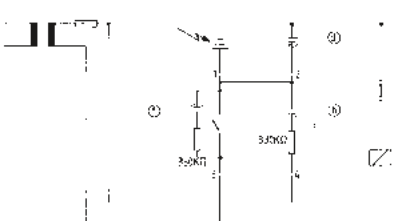

- (h) yellow indicator light not flashing





# MEASURING DISCONNECT BLOCKS WITH SCREW CONNECTION



Wieland Electric's selos WKN 6 TK block offers a simple and effective DIN rail block solution for use in measuring circuits for current, voltage or energy. All circuits in everyday practice can be neatly implemented with the measuring disconnect block and a few accessory parts. Only two blocks are needed for simple transformer circuits.

The main focus during the development of this block was clear and simple handling as well as universal application. All switching states of the block and the converter circuit are clearly recognizable and the extensive accessory program is easy to use.

The block and the accessories meet the requirements of protection against accidental finger touch as per BGV A2.

### Technical data as per EN 60947-7:

Rated cross section:	6 mm <sup>2</sup>	Rated current:	57 A
Rated voltage:	400 V	Connection capacity:	0.5 - 10 mm <sup>2</sup>

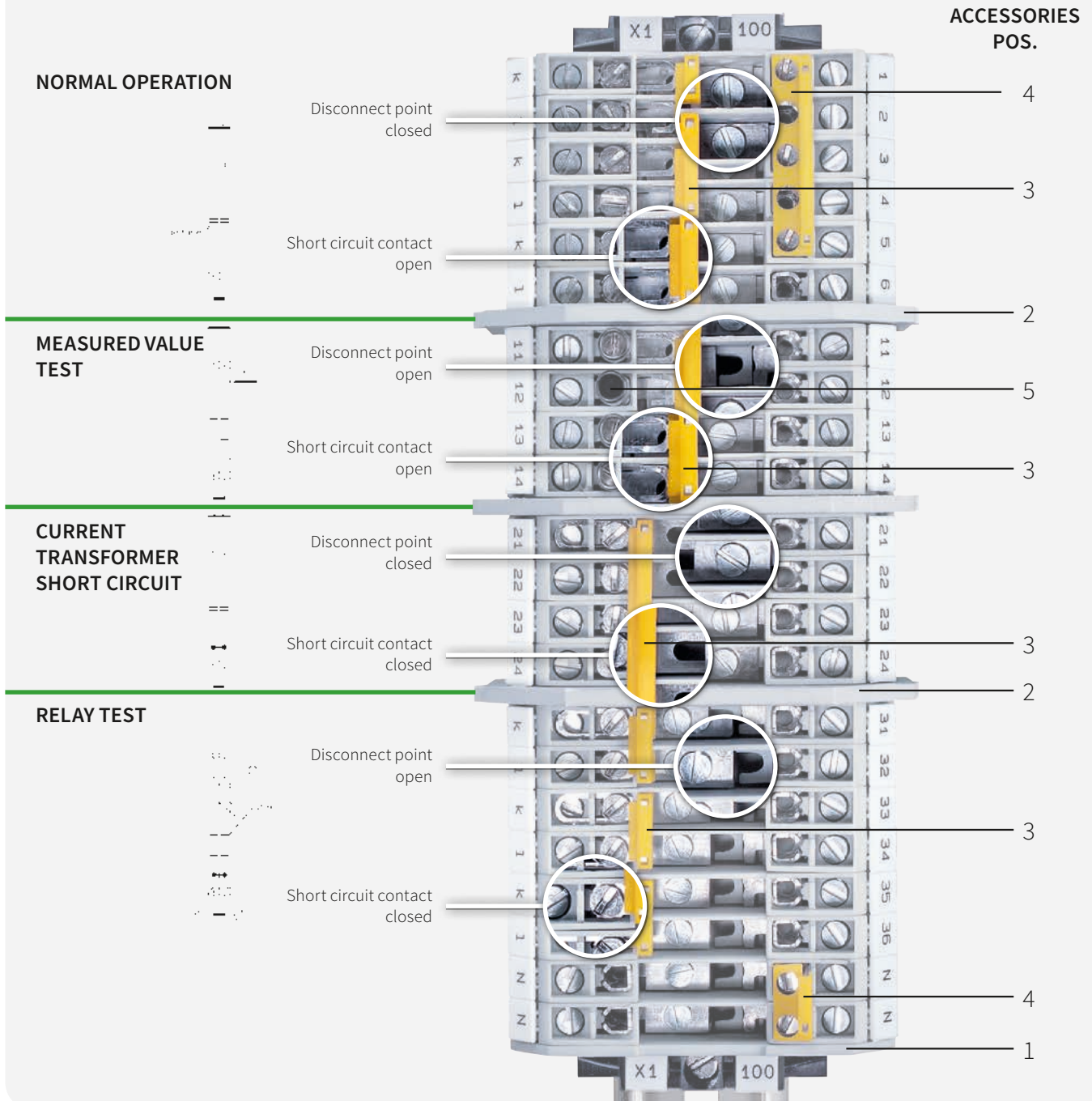

# MEASURING DISCONNECT BLOCKS WITH SCREW CONNECTION

## WKN 6 TK

- Measuring disconnect block for mounting on TS 35
- Nominal cross section 6 mm<sup>2</sup>

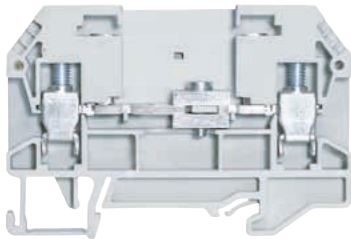

Description	Type	Part No.	Std. Pack
Measuring disconnect block	WKN6 TK	56.106.0055.0	50
Feed-through block	WKN6 TK D	56.106.0155.0	50

### GENERAL DATA

Width / length / height, incl. TS 7.5	8 mm / 73 mm / 58 mm
Wire strip length	12 mm
Approvals	

### TECHNICAL DATA

	IEC	UL	CSA
	EN 60947-7-1		
Cross section fine-stranded	0.5 – 6 mm <sup>2</sup>		
Cross section solid/stranded	0.5 – 10 mm <sup>2</sup>		
Cross section, AWG			
Rated current	57 A		
Rated voltage	500 V		
Rated impulse voltage	6 kV		
Pollution degree	3		

## WKN 6 TK SF

- Measuring disconnect block with spring support for mounting on TS 35
- Nominal cross section 6 mm<sup>2</sup>

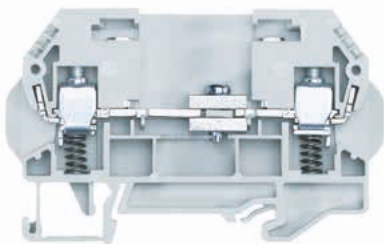

Description	Type	Part No.	Std. Pack
Measuring disconnect block	WKN6 TK SF	56.106.0755.0	50
Feed-through block	WKN6 TK SFD	56.106.0855.0	50

### GENERAL DATA

Width / length / height, incl. TS 7.5	8 mm / 73 mm / 58 mm
Wire strip length	12 mm
Approvals	

### TECHNICAL DATA

	IEC	EA TS 50-18
	EN 60947-7-1	
Cross section fine-stranded	0.5 – 6 mm <sup>2</sup>	
Cross section solid/stranded	0.5 – 10 mm <sup>2</sup>	
Cross section, AWG		
Rated current	57 A	25 A
Rated voltage	500 V	500 V
Rated impulse voltage	6 kV	
Pollution degree	3	

## ACCESSORIES FOR SELOS WKN 6 TK...

ACCESSORIES	Type	Part No.	Std. Pack
1. End plate	2 mm APN 6 TK	07.313.1755.0	10
2. Partition	TW 6 TK	07.312.0453.0	10
3. Sliding short-circuit slide, insulated	2-pole IVS WKN6 TK-2	Z7.282.7229.0	10
	3-pole IVS WKN6 TK-3	Z7.282.7329.0	10
	4-pole IVS WKN6 TK-4	Z7.282.7429.0	10
	4. Cross connector with screws, insulated	2-pole IVB WKN6 TK-2	Z7.282.6229.0
	3-pole IVB WKN6 TK-3	Z7.282.6329.0	10
	4-pole IVB WKN6 TK-4	Z7.282.6429.0	10
	5-pole IVB WKN6 TK-5	Z7.282.6529.0	10
	6-pole IVB WKN6 TK-6	Z7.282.6629.0	10
5. Test socket	gray SBN 4 GRAU	Z5.511.3553.0	10
	violet SBN 4 VIOLETT	Z5.511.3553.9	10
	green SBN 4 GRÜN	Z5.511.3553.7	10
	yellow SBN 4 GELB	Z5.511.3553.8	10
	blue SBN 4 BLAU	Z5.511.3553.6	10
6. Disconnect locking device	SP WKN 6 TK	05.566.6855.9	50
Jumper comb for WKN 6 TK	2-pole IVK WKN 6TK-2	Z7.255.8227.0	10
	3-pole IVK WKN 6TK-3	Z7.255.8327.0	10
	4-pole IVK WKN 6TK-4	Z7.255.8427.0	10
	5-pole IVK WKN 6TK-5	Z7.255.8527.0	10
	6-pole IVK WKN 6TK-6	Z7.255.8627.0	10



# MEASURING DISCONNECT BLOCKS WITH SCREW CONNECTION WK6 TK

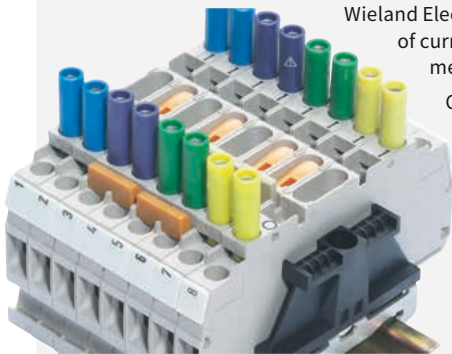

Wieland Electric's selos WK 6 TK block offers an optimal DIN rail block solution for all types of measuring circuits of current, voltage or energy. All circuits occurring during everyday practice can be implemented with the measuring disconnect block and a few accessories.

Complete insulated selectable connecting links are available as standard, as are insulated test sockets in all conventional signal colors. Two additional jumpering facilities permit the installation of fixed cross connections (e.g., for internal distribution of the k point of converter circuits). Standard cross connectors in a wide variety of numbers of pins are available for this purpose. The jumpers are easy to disconnect so that you can skip over blocks.

**Technical data as per EN 60947-7:**

Rated cross section:	6 mm <sup>2</sup>	Rated current:	32A
Rated voltage:	400V	Connection capacity:	0.5-10 mm <sup>2</sup>

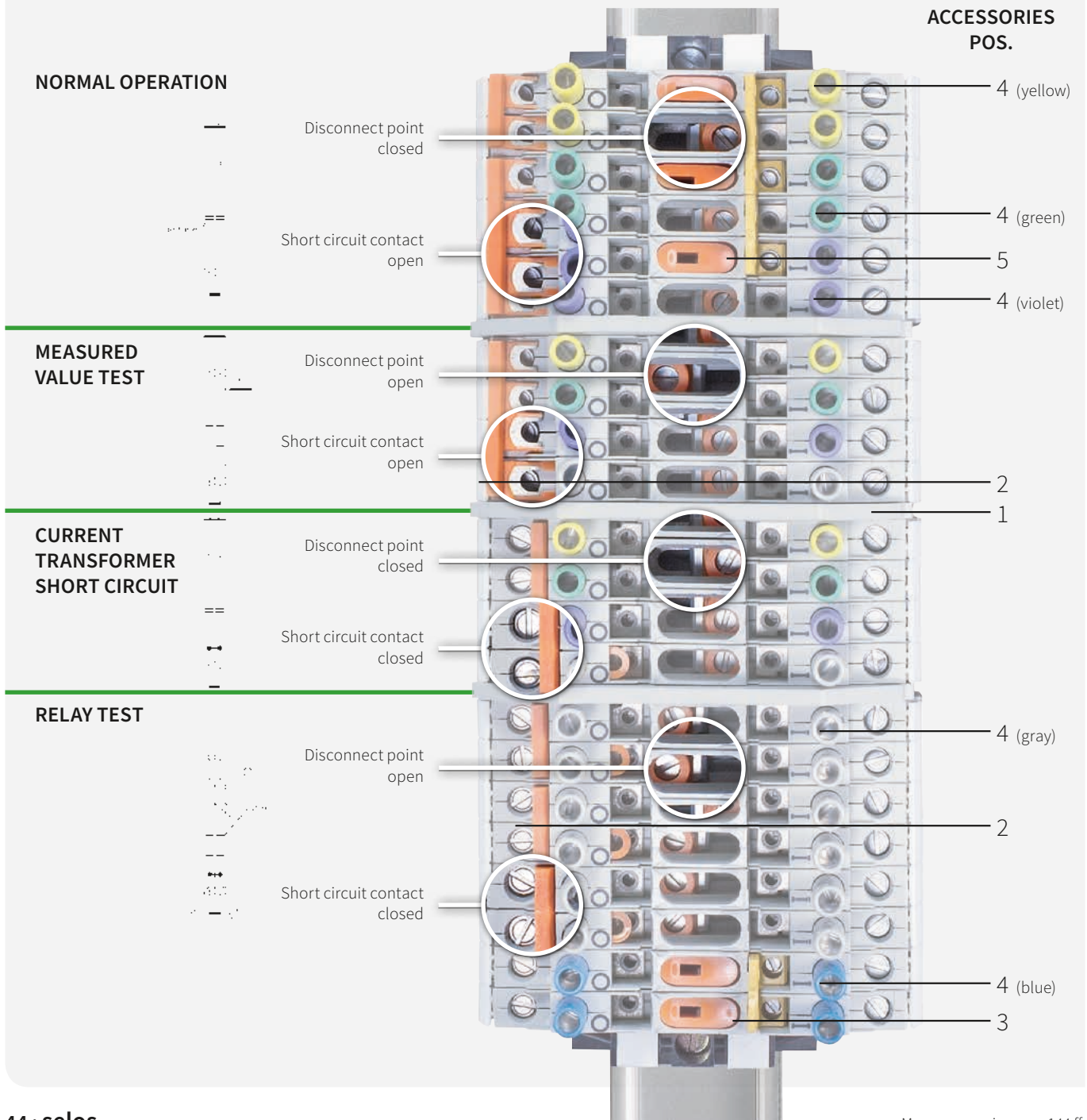

# MEASURING DISCONNECT BLOCKS WITH SCREW CONNECTION WK6 TK

## WK6 TK/35

- Measuring disconnect block for mounting on TS 35
- Nominal cross section 6 mm<sup>2</sup>

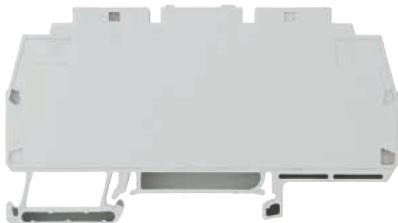

Description	Type	Part No.	Std. Pack
Measuring disconnect block	WK6 TK/35	56.106.0553.0	50
<b>GENERAL DATA</b>			
Width / length / height, incl. TS 7.5	8 mm / 87 mm / 49 mm		
Wire strip length	12 mm		
Approvals			
<b>TECHNICAL DATA</b>			
	<b>IEC</b>	<b>UL</b>	<b>CSA</b>
For use with insulating sleeves	EN 60947-7-1		
Cross section fine-stranded	0.5 – 6 mm <sup>2</sup>		
Cross section solid/stranded	0.5 – 10 mm <sup>2</sup>		
Cross section, AWG		20 – 8	20 – 8
Rated current	32 A	45 A	45 A
Rated voltage	400 V	600 V	300 V
Rated impulse voltage	6 kV		
Pollution degree	3		

## WK6 TK P3/35

- Measuring disconnect block with mounted test sockets for mounting on TS 35
- Nominal cross section 6 mm<sup>2</sup>

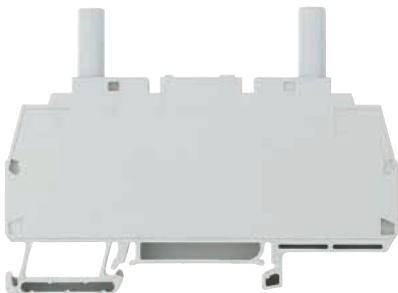

Description	Type	Part No.	Std. Pack
Measuring disconnect block	WK6 TK P3/35	56.106.0653.0	50
<b>GENERAL DATA</b>			
Width / length / height, incl. TS 7.5	8 mm / 87 mm / 62 mm		
Wire strip length	12 mm		
Approvals			
<b>TECHNICAL DATA</b>			
	<b>IEC</b>	<b>UL</b>	<b>CSA</b>
For use with insulating sleeves	EN 60947-7-1		
Cross section fine-stranded	0.5 – 6 mm <sup>2</sup>		
Cross section solid/stranded	0.5 – 10 mm <sup>2</sup>		
Cross section, AWG		20 – 8	20 – 8
Rated current	32 A	45 A	45 A
Rated voltage	400 V	600 V	300 V
Rated impulse voltage	6 kV		
Pollution degree	3		

## ACCESSORIES FOR SELOS WK6 TK.../35

ACCESSORIES	Type	Part No.	Std. Pack
1. Partition	TW 6 TK	07.312.0453.0	10
2. Sliding short-circuit slide, insulated	2-pole	IVS WK6 TK-2	50
	3-pole	IVS WK6 TK-3	50
	4-pole	IVS WK6 TK-4	50
3. Cross connector with screws, insulated	2-pole	IVB WK6 TK-2	50
	3-pole	IVB WK6 TK-3	50
	4-pole	IVB WK6 TK-4	50
	5-pole	IVB WK6 TK-5	50
	10-pole	IVB WK6 TK-10	50
4. Test socket	gray	SB 4 GRAU	10
	violet	SB 4 VIOLETT	10
	green	SB 4 GRÜN	10
	yellow	SB 4 GELB	10
5. Disconnect locking device	blue	SB 4 BLAU	10
	SP WK6 TK	05.563.5453.0	50



# SCREW TYPE TERMINAL BLOCKS WITH SPRING SUPPORT

## WKN 6 SF

- Feed-through block with spring support for mounting on TS 35 and TS 32
- Nominal cross section 6 mm<sup>2</sup>

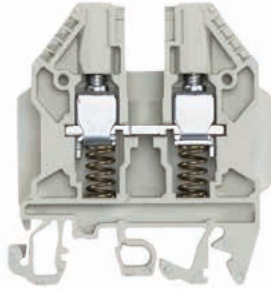

Description	Type	Part No.	Std. Pack
Feed-through block	gray WKN 6 SF	57.506.0555.0	100
<b>GENERAL DATA</b>			
Width / length / height, incl. TS 7.5	8 mm / 54 mm / 57 mm		
Wire strip length	11 mm		
Approvals			
<b>TECHNICAL DATA</b>		<b>IEC</b>	<b>EA TS 50-18</b>
		EN 60947-7-1	
Cross section fine-stranded	0.5 – 6 mm <sup>2</sup>		
Cross section solid/stranded	0.5 – 10 mm <sup>2</sup>		
Cross section, AWG			
Rated current	41 A	30 A	
Rated voltage	800 V	500 V	
Rated impulse voltage	8 kV		
Pollution degree	3		
<b>ACCESSORIES</b>			
End plate	gray APN 6 SF	07.313.2355.0	10
Partition	gray TW 6 TK	07.312.0453.0	10
Cross connector with screws	2-pole IVB WK 6 - 2	Z7.282.2227.0	10
insulated	3-pole IVB WK 6 - 3	Z7.282.2327.0	10
	up to 12-pole IVB WK 6 - 12	Z7.282.3227.0	10
Single cover f. cross conn. with marking facility	AD VB 6 GELB	04.326.2253.8	10
Cover with warning symbol	yellow AD VB 8/4 GELB	04.343.4956.8	10

## WKN 10 SF

- Feed-through block with spring support for mounting on TS 35 and TS 32
- Nominal cross section 10 mm<sup>2</sup>

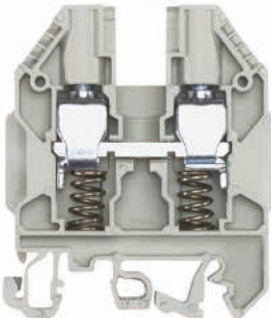

Description	Type	Part No.	Std. Pack
Feed-through block	gray WKN 10 SF	57.510.0555.0	100
<b>GENERAL DATA</b>			
Width / length / height, incl. TS 7.5	10 mm / 55 mm / 64 mm		
Wire strip length	13 mm		
Approvals			
<b>TECHNICAL DATA</b>		<b>IEC</b>	<b>EA TS 50-18</b>
		EN 60947-7-1	
Cross section fine-stranded	2.5 – 10 mm <sup>2</sup>		
Cross section solid/stranded	1.5 – 16 mm <sup>2</sup>		
Cross section, AWG			
Rated current	57 A	30 A	
Rated voltage	800 V	500 V	
Rated impulse voltage	8 kV		
Pollution degree	3		
<b>ACCESSORIES</b>			
End plate	gray APN 10 SF	07.313.2455.0	10
Partition	gray TW 6 TK	07.312.0453.0	10
Cross connector with screws	2-pole IVB WK 10 - 2	Z7.283.2227.0	10
insulated	3-pole IVB WK 10 - 3	Z7.283.2327.0	10
	up to 12-pole IVB WK 10 - 12	Z7.283.3227.0	10
Single cover f. cross conn. with marking facility	AD VB 10 GELB	04.326.2353.8	10
Cover with warning symbol	yellow AD VB 10/4 GELB	04.343.5056.8	10



# DIN RAIL TERMINAL BLOCKS WITH RING LUG CONNECTION

## WRT 6

- Feed-through block with ring lug connection for mounting on TS 35
- Nominal cross section 6 mm<sup>2</sup>

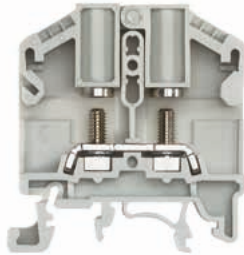

Description	Type	Part No.	Std. Pack
Feed-through block	gray WRT 6	57.106.1155.0	100
<b>GENERAL DATA</b>			
Width / length / height, incl. TS 7.5	11 mm / 49 mm / 51 mm		
Wire strip length	10 mm		
Approvals			
<b>TECHNICAL DATA</b>		<b>IEC</b>	<b>UL</b> <b>CSA</b>
		EN 60947-7-1	
Cross section fine-stranded	1.5 – 6 mm <sup>2</sup>		
Cross section solid/stranded	1.5 – 6 mm <sup>2</sup>		
Cross section, AWG			22 – 8      22 – 8
Rated current	41 A	50 A	50 A
Rated voltage	1000 V	600 V	600 V
Rated impulse voltage	8 kV		
Pollution degree	3		
<b>ACCESSORIES</b>		<b>Type</b>	<b>Part No.</b> <b>Std. Pack</b>
End plate	gray	APRT 6	07.300.6955.0      10
Partition	gray	TW 6 TK	07.312.0453.0      10
Cross connector, insulated	2-pole	IVB WRT 6 TK - 2	Z7.250.5227.0      10
	3-pole	IVB WRT 6 TK - 3	Z7.250.5327.0      10
	4-pole	IVB WRT 6 TK - 4	Z7.250.5427.0      10

## WRT 6 TK

- Measuring disconnect block with ring lug connection for mounting on TS 35
- Nominal cross section 6 mm<sup>2</sup>

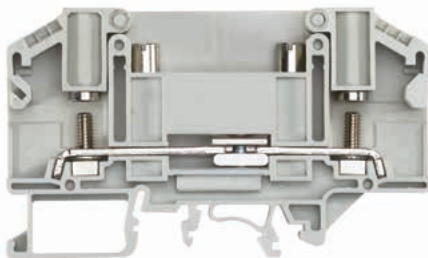

Description	Type	Part No.	Std. Pack
Measuring disconnect block	gray WRT 6 TK	57.106.1055.0	100
<b>GENERAL DATA</b>			
Width / length / height, incl. TS 7.5	11 mm / 86 mm / 51 mm		
Wire strip length	10 mm		
Approvals			
<b>TECHNICAL DATA</b>		<b>IEC</b>	<b>UL</b> <b>CSA</b>
		EN 60947-7-1	
Cross section fine-stranded	1.5 – 6 mm <sup>2</sup>		
Cross section solid/stranded	1.5 – 6 mm <sup>2</sup>		
Cross section, AWG			22 – 8      22 – 8
Rated current	41 A	35 A	35 A
Rated voltage	1000 V	600 V	600 V
Rated impulse voltage	8 kV		
Pollution degree	3		
<b>ACCESSORIES</b>		<b>Type</b>	<b>Part No.</b> <b>Std. Pack</b>
End plate	gray	APRT 6 TK	07.300.7055.0      10
Partition	gray	TW 6 TK	07.312.0453.0      10
Cross connector, insulated	2-pole	IVB WRT 6 TK - 2	Z7.250.5227.0      10
	3-pole	IVB WRT 6 TK - 3	Z7.250.5327.0      10
	4-pole	IVB WRT 6 TK - 4	Z7.250.5427.0      10

# DIN RAIL TERMINAL BLOCK WITH DOUBLE CLAMPING SCREW

## WKN 16 DS

- Feed-through block with double screw connection for mounting on TS 32 and 35
- Nominal cross section 16 mm<sup>2</sup>



Description	Type	Part No.	Std. Pack
Feed-through block	gray WKN 16 DS	57.016.5055.0	50
<b>GENERAL DATA</b>			
Width / length / height, incl. TS 7.5	10 mm / 68 mm / 54 mm		
Wire strip length	18 mm		
Approvals			
<b>TECHNICAL DATA</b>		<b>IEC</b>	<b>CSA</b>
		EN 60947-7-1	
Cross section fine-stranded	1,5 – 16 mm <sup>2</sup>		
Cross section solid/stranded	1,5 – 25 mm <sup>2</sup>		
Cross section, AWG			16 – 6
Rated current	76 A		65 A
Rated voltage	800 V		600 V
Rated impulse voltage	8 kV		
Pollution degree	3		
<b>ACCESSORIES</b>		<b>Type</b>	<b>Part No.</b> <b>Std. Pack</b>
End plate	gray	APN 16 DS	07.313.2255.0      10
Cross connector, insulated	2-pole	IVB WKN 10 - 2	Z7.283.2227.0      10
	3-pole	IVB WKN 10 - 3	Z7.283.2327.0      10
	12-pole	IVB WKN 10 - 12	Z7.283.3227.0      10







# SELOS WRT

## THE NEW GENERATION OF HIGH CURRENT TERMINALS

The selos WRT high current terminals are the new generation of ring lug terminals for safe and maintenance-free energy transmission.

A broad range and a clear focus on customer benefits makes selos WRT a robust solution for connecting conductors to 300 mm<sup>2</sup> and 520 A.

### FEATURES

- Rugged design
- Safe and maintenance-free
- Flexible potential distribution
- Reliable touch protection

### SIMPLE MOUNTING

- On TS 35 or on the mounting plate
- Few parts – nut with integrated spring washer

### SAFE AND MAINTENANCE-FREE

- High performance
- Up to 300 mm<sup>2</sup> / 520 A / 1000 V
- Maintenance-free screw connection
- Vibration-proof

### TOUCH-PROOF APPLICATION

- Cover easy to open and close
- Test opening – completely touch-proof voltage measurement
- Cover can be individually adapted

### FLEXIBLE POTENTIAL DISTRIBUTION

- Cross connectors for simple potential distribution up to nominal currents
- Multi-conductor connection possible, 2 cable lugs per connection point

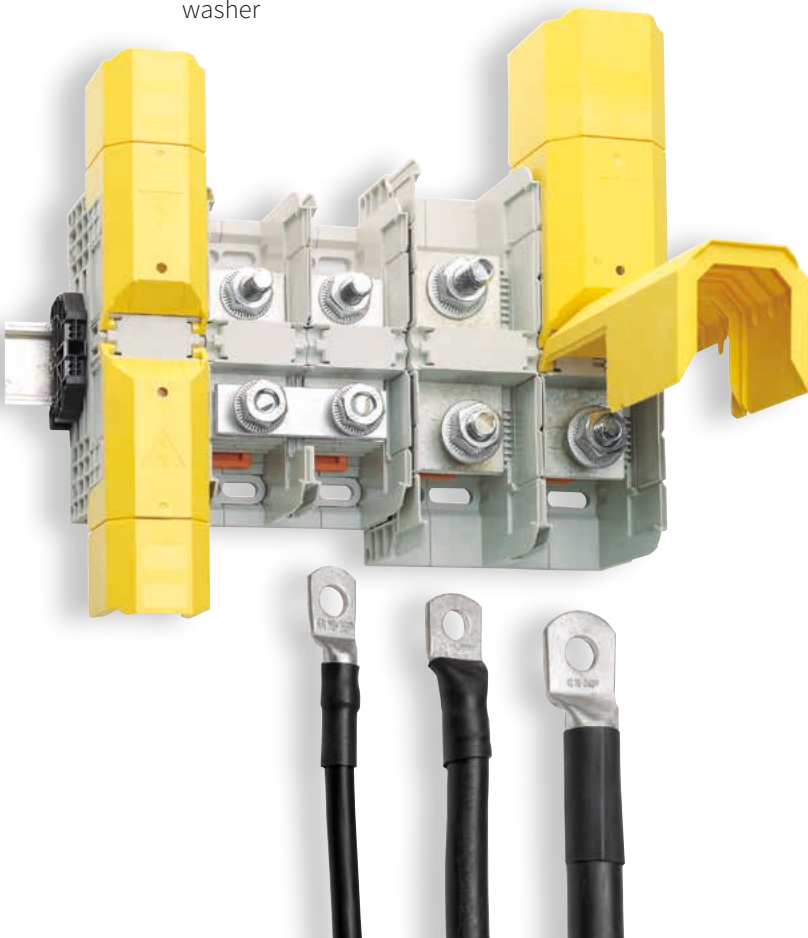

# HIGH CURRENT TERMINALS WITH SCREW CONNECTION

## WRT 35

- High current terminal block for mounting on TS 35
- Nominal cross-section 35 mm<sup>2</sup>
- Bolt connection M6



Description	Type	Part No.	Std. Pack	
High current terminal block	WRT 35 / M6	56.135.1055.0	10	
<b>GENERAL DATA</b>				
Width / length / height (incl. TS 7.5)	27 mm / 107 mm / 51 mm			
Width / length / height (incl. TS 7.5 & cover)	27 mm / 131 mm / 60 mm			
Screw size	M6			
Approvals				
<b>Technical data</b>		<b>IEC</b>	<b>UL</b>	<b>CSA</b>
Cross section fine-stranded	2.5 - 50 mm <sup>2</sup>			
Cross section solid/stranded	2.5 - 50 mm <sup>2</sup>			
Cross-section, AWG	14 - 1/0		14 - 1/0	
Rated current	125 A	130 A	130 A	
Rated voltage	1000 V	1000 V	1000 V	
Rated impulse voltage	8 kV			
Pollution degree	3			
Torque	3 - 6 Nm			
<b>ACCESSORIES</b>		<b>Type</b>	<b>Part No.</b>	<b>Std. Pack</b>
Cover (2 piece/terminal required)		AD WRT 35	07.431.7053.8	20
Cross connector, for 2 terminals		VB WRT 35-2	07.201.1227.6	5
Cross connector, for 3 terminals		VB WRT 35-3	07.201.1327.6	5

## WRT 70

- High current terminal block for mounting on TS 35
- Nominal cross-section 70 mm<sup>2</sup>
- Bolt connection M8



Description	Typ	Part No.	Std. Pack	
High current terminal block	WRT 70	56.170.1055.0	10	
<b>GENERAL DATA</b>				
Width / length / height (incl. TS 7.5)	32 mm / 132 mm / 61 mm			
Width / length / height (incl. TS 7.5 & cover)	32 mm / 180 mm / 70 mm			
Screw size	M8			
Approvals				
<b>TECHNICAL DATA</b>		<b>IEC</b>	<b>UL</b>	<b>CSA</b>
Cross section fine-stranded	2.5 - 95 mm <sup>2</sup>			
Cross section solid/stranded	2.5 - 95 mm <sup>2</sup>			
Cross-section, AWG	14 - 3/0		14 - 3/0	
Rated current	192 A	175 A	175 A	
Rated voltage	1000 V	1000 V	1000 V	
Rated impulse voltage	8 kV			
Pollution degree	3			
Torque	6 - 12 Nm			
<b>ACCESSORIES</b>		<b>Type</b>	<b>Part No.</b>	<b>Std. Pack</b>
Cover (2 piece/terminal required)		AD WRT 70	07.431.7153.8	20
Cross connector, for 2 terminals		VB WRT 70-2	07.201.3227.6	5
Cross connector, for 3 terminals		VB WRT 70-3	07.201.3327.6	5

## WRT 120

- High current terminal block for mounting on TS 35
- Nominal cross-section 120 mm<sup>2</sup>
- Bolt connection M10



Description	Type	Part No.	Std. Pack	
High current terminal block	WRT 120	56.197.1055.0	5	
<b>General data</b>				
Width / length / height (incl. TS 7.5)	42 mm / 133 mm / 72 mm			
Width / length / height (incl. TS 7.5 & cover)	42 mm / 226 mm / 80 mm			
Screw size	M10			
Approvals				
<b>Technical data</b>		<b>IEC</b>	<b>UL</b>	<b>CSA</b>
Cross section fine-stranded	to 120 mm <sup>2</sup>			
Cross section solid/stranded	6 - 150 mm <sup>2</sup>			
Cross-section, AWG	10 - 250 kcmil		10 - 250 kcmil	
Rated current	269 A	225/310 A *)	225/310 A *)	
Rated voltage	1000 V	1000 V	1000 V	
Rated impulse voltage	8 kV			
Pollution degree	3			
Torque	10 - 20 Nm			
<b>Accessories</b>		<b>Type</b>	<b>Part No.</b>	<b>Std. Pack</b>
Cover (2 piece/terminal required)		AD WRT 120	07.431.7253.8	10
Cross connector, for 2 terminals		VB WRT 120-2	07.201.5227.6	5
Cross connector, for 3 terminals		VB WRT 120-3	07.201.5327.6	5

\*) field / factory wiring

## WRT 185

- High current terminal block for mounting on TS 35
- Nominal cross-section 185 mm<sup>2</sup>
- Bolt connection M12



Description	Type	Part No.	Std. Pack
High current terminal block	WRT 185	56.198.1055.0	5
<b>General data</b>			
Width / length / height (incl. TS 7.5)	55 mm / 164 mm / 78 mm		
Width / length / height (incl. TS 7.5 & cover)	55 mm / 288 mm / 90 mm		
Screw size	M12		
Approvals			
<b>Technical data</b>			
	<b>IEC</b>	<b>UL</b>	<b>CSA</b>
Cross section fine-stranded	to 185 mm <sup>2</sup>		
Cross section solid/stranded	10 - 240 mm <sup>2</sup>		
Cross-section, AWG		8 - 500 kcmil	8 - 500 kcmil
Rated current	353 A	380 A	380 A
Rated voltage	1000 V	1000 V	1000 V
Rated impulse voltage	8 kV		
Pollution degree	3		
Torque	14 - 31 Nm		
<b>Accessories</b>			
	<b>Type</b>	<b>Part No.</b>	<b>Std. Pack</b>
Cover (2 piece/terminal required)	AD WRT 185/300	07.431.7353.8	10
Cross connector, for 2 terminals	VB WRT 185-2	07.201.7227.6	5
Cross connector, for 3 terminals	VB WRT 185-3	07.201.7327.6	5

## WRT 300

- High current terminal block for mounting on TS 35
- Nominal cross-section 300 mm<sup>2</sup>
- Bolt connection M16



Description	Type	Part No.	Std. Pack
High current terminal block	WRT 300	56.199.1055.0	5
<b>General data</b>			
Width / length / height (incl. TS 7.5)	55 mm / 164 mm / 78 mm		
Width / length / height (incl. TS 7.5 & cover)	55 mm / 288 mm / 90 mm		
Screw size	M16		
Approvals			
<b>Technical data</b>			
	<b>IEC</b>	<b>UL</b>	<b>CSA</b>
Cross section fine-stranded	to 300 mm <sup>2</sup>		
Cross section solid/stranded	25 - 240 mm <sup>2</sup>		
Cross-section, AWG		6 - 600 kcmil	6 - 600 kcmil
Rated current	520 A	420/510 A *)	420/510 A *)
Rated voltage	1000 V	1000 V	1000 V
Rated impulse voltage	8 kV		
Pollution degree	3		
Torque	25 - 60 Nm		
<b>Accessories</b>			
	<b>Type</b>	<b>Part No.</b>	<b>Std. Pack</b>
Cover (2 piece/terminal required)	AD WRT 185/300	07.431.7353.8	10
Cross connector, for 2 terminals	VB WRT 300-2	07.201.9227.6	5
Cross connector, for 3 terminals	VB WRT 300-3	07.201.9327.6	5

\*) field / factory wiring



# SELOS POWER LINE

## HIGH CURRENT TERMINAL BLOCKS WITH SCREW CONNECTION

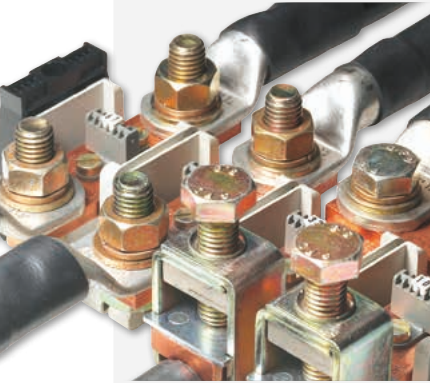

selos POWER LINE is designed for use in mechanical and plant engineering, railway, and battery applications.

Wieland offers a program which was especially developed for high current applications. The portfolio includes feed through blocks and ring lug terminals. The RFK type feed through blocks include four different cross sections between 95 and 240 mm<sup>2</sup> with different types of connection (e.g., rising cage or ring lug connection).

Ring lug terminals augment the selos POWER LINE product line. Blocks with ring lug sizes from M 6 to M 12 are available for the connection of wires with crimped cable lugs.

Extensive accessories optimize the selos POWER LINE for a wide variety of applications.

### Technical data as per EN 60947-7:

Rated cross section:	95 mm <sup>2</sup> - 240 mm <sup>2</sup>	Rated current:	up to 415 A
Rated voltage:	1000 V		



### HIGH CURRENT BLOCKS, TYPE RFK

- Up to 240 mm<sup>2</sup> rated cross section
- Cable connection via ring lug connection technology, direct connection with rising cage or hybrid solutions
- Current carrying and cross connectors made of E-Cu
- Screws maintain torque via clamping body design, as well as lock washers

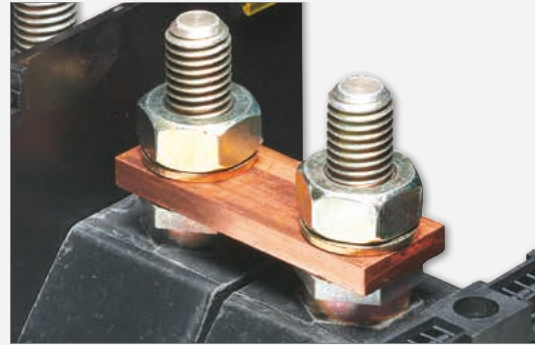

### RING LUG CONNECTION BLOCKS

- For the connection of cable lugs in versions from M 6 to M 12
- Screws maintain torque via lock washers
- Approved for international rail transportation standards

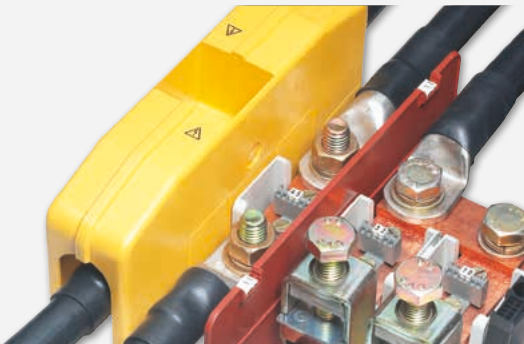

### ACCESSORIES FOR SELOS POWER

- Covers for provision of protection against accidental touch
- Cross connectors made of E-Cu; 2, 3 and 4-pole
- Partition plates for visual and electrical separation
- All components can be marked with the standard Wieland marking system

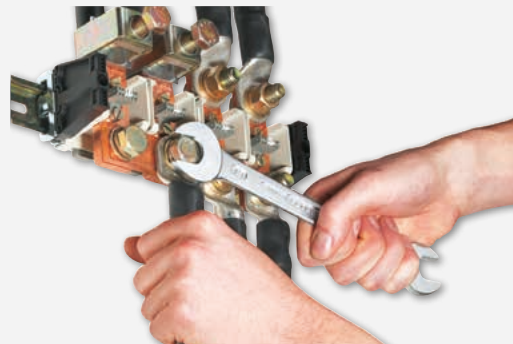

### MOUNTING NOTICE

- When tightening the block screws, we recommend countering by holding the wire to avoid deformation of the mounting rail and to keep the foot of the block free of torsional forces.



# HIGH CURRENT BLOCKS WITH SCREW CONNECTION



## BK M .../35

- Ring lug terminal for mounting on TS 35



Description	Type	Part No.	Std. Pack	
Ring lug terminal	BK M 6/35	32.530.0053.0	25	
	BK M 8/35	32.540.0053.0	25	
	BK M 10/35	32.550.0053.0	25	
	BK M 12/35	32.560.0053.0	25	
<b>GENERAL DATA</b>				
Approvals				
<b>TECHNICAL DATA</b>				
	<b>BK M 6</b>	<b>BK M 8</b>	<b>BK M 10</b>	<b>BK M 12</b>
Width / height	19 x 56	24 x 65	35 x 72	35 x 74
Rated current	125 A	150 A	265 A	265 A
Rated voltage	1000 V / 8 kV / 3 with partition TW BK			
<b>ACCESSORIES</b>				
	<b>Type</b>	<b>Part No.</b>	<b>Std. Pack</b>	
Partition	for BK M 6	TW BK M 6/35	07.340.3553.0	25
	for BK M 8	TW BK M 8/35	07.340.3653.0	25
	for BK M 10	TW BK M 10-12/35	07.340.3753.0	25
	for BK M 12	TW BK M 10-12/35	07.340.3753.0	25
Cross connector for tab connection blocks, from E-Cu	for 2 blocks BK M 6	VB BK M 6/35-2	07.205.5227.0	20
	for 3 blocks BK M 6	VB BK M 6/35-3	07.205.5327.0	10
	for 2 blocks BK M 8	VB BK M 8/35-2	07.205.7227.0	20
	for 3 blocks BK M 8	VB BK M 8/35-3	07.205.7327.0	10
	for 2 blocks BK M 10	VB BK M 10/35-2	07.205.8227.0	20
	for 3 blocks BK M 10	VB BK M 10/35-3	07.205.8327.0	10
	for 2 blocks BK M 12	VB BK M 12/35-2	07.205.9227.0	20
	for 3 blocks BK M 12	VB BK M 12/35-3	07.205.9327.0	10
	Cover	for BK M 6	AD BK M 6-8/35	04.304.0181.0
for BK M 8		AD BK M 6-8/35	04.304.0181.0	1
for BK M 10		AD BK M 10-12/35	04.304.0281.0	1
for BK M 12		AD BK M 10-12/35	04.304.0281.0	1
Installation clip for cover		05.564.0753.0	10	

# HIGH CURRENT BLOCKS WITH SCREW CONNECTION

## RFK 1/95... S35

- High current block for mounting on TS 35
- Nominal cross section 95 mm<sup>2</sup>



Description	Type	Part No.	Std. Pack	
Feed-through block	gray	<b>F</b> RFK 1/95 F S 35	56.395.0055.0	10
		<b>K</b> RFK 1/95 K S 35	56.395.0155.0	10
		<b>FK</b> RFK 1/95 FK S 35	56.395.0255.0	10
		<b>FM</b> RFK 1/95 FM S 35	56.395.1055.0	10
		<b>FMK</b> RFK 1/95 FMK S 35	56.395.1255.0	10

GENERAL DATA				
Width / length / height, incl. TS 7.5	see list p. 53			
Wire strip length	27 mm			
Approvals				
TECHNICAL DATA		IEC	UL	CSA
		EN 60947-7-1		
Cross section fine-stranded	16 – 95 mm <sup>2</sup>			
Cross section solid/stranded	16 – 95 mm <sup>2</sup>			
Cross section, AWG			6 - 3/0	6 - 3/0
Rated current	250 A		200 A	200 A
Rated voltage	1000 V		600 V	600 V
Rated impulse voltage	8 kV			
Pollution degree	3			
ACCESSORIES		Type	Part No.	Std. Pack
Cover for RFK 1 /...	yellow	AD RFK 95	27.409.5753.0	10
Partition / end plate	2.8 mm thick	TE/RFK 1/95	07.340.0353.0	50
Cross connector, from E-Cu	for 2 blocks	VB RFK 1/95/2/32	07.205.1227.0	20
	for 3 blocks	VB RFK 1/95/3/32	07.205.1327.0	10
	for 4 blocks	VB RFK 1/95/4/32	07.205.1427.0	10

## RFK 1/150... S35

- High current block for mounting on TS 35
- Nominal cross section 150 mm<sup>2</sup>

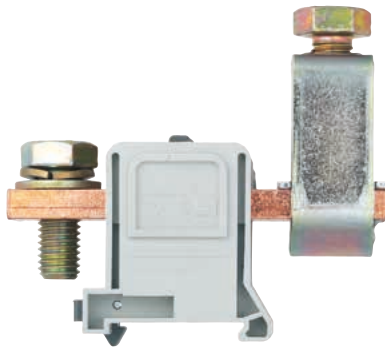

Description	Type	Part No.	Std. Pack	
Feed-through block	gray	<b>F</b> RFK 1/150 F S35	56.397.0055.0	10
		<b>K</b> RFK 1/150 K S35	56.397.0155.0	10
		<b>FK</b> RFK 1/150 FK S35	56.397.0255.0	10
		<b>FMK</b> RFK 1/150 FMK S35	56.397.1255.0	10

GENERAL DATA				
Width / length / height, incl. TS 7.5	see list p. 53			
Wire strip length	27 mm			
Approvals				
TECHNICAL DATA		IEC	UL	CSA
		EN 60947-7-1		
Cross section fine-stranded	70 – 150 mm <sup>2</sup>			
Cross section solid/stranded	70 – 150 mm <sup>2</sup>			
Cross section, AWG			0 - 300 kcmil	0 - 300 kcmil
Rated current	335 A		275 A	300 A
Rated voltage	1000 V		600 V	600 V
Rated impulse voltage	8 kV			
Pollution degree	3			
ACCESSORIES		Type	Part No.	Std. Pack
Cover for RFK 1 /...	yellow	AD RFK 150 - 240	27.409.5853.0	10
Partition / end plate	2.8 mm thick	TE/RFK 1/150 - 240 PA	07.340.1053.0	50
Cross connector, from E-Cu	for 2 blocks	VB RFK 1/185/2	07.201.4227.0	10
	for 3 blocks	VB RFK 1/185/3	07.201.4327.0	10
	for 4 blocks	VB RFK 1/185/4	07.201.4427.0	10



## RFK 1/185... S35

- High current block for mounting on TS 35
- Nominal cross section 185 mm<sup>2</sup>

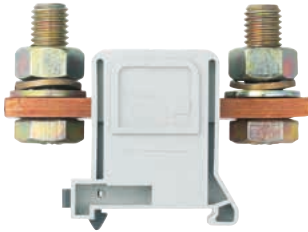

Description	Type	Part No.	Std. Pack
Feed-through block	gray F	RFK 1/185 F S 35	56.398.0055.0
	FM	RFK 1/185 FM S 35	56.398.1055.0

### GENERAL DATA

Width / length / height, incl. TS 7.5	see list			
Wire strip length	27 mm			
Approvals				
TECHNICAL DATA		IEC	UL	CSA
For use with insulating sleeves		EN 60947-7-1		
Cross section fine-stranded		70 - 200 mm <sup>2</sup>		
Cross section solid/stranded		70 - 200 mm <sup>2</sup>		
Cross section, AWG			0 - 400 kcmil	0 - 400 kcmil
Rated current		353 A	375 A	375 A
Rated voltage		1000 V	600 V	600 V
Rated impulse voltage		8 kV		
Pollution degree		3		

ACCESSORIES	Type	Part No.	Std. Pack
Cover for RFK 1 /..., yellow		AD RFK 150 - 240	27.409.5853.0
Partition / end plate	2.8mm thick	TE/RFK 1/150 - 240 PA	07.340.1053.0
Cross connector, from E-Cu	for 2 blocks	VB RFK 1/185/2	07.201.4227.0
	for 3 blocks	VB RFK 1/185/3	07.201.4327.0
	for 4 blocks	VB RFK 1/185/4	07.201.4427.0

## RFK 1/240... S35

- High current block for mounting on TS 35
- Nominal cross section 240 mm<sup>2</sup>
- \* Use only cable lugs type DIN 46234



Description	Type	Part No.	Std. Pack
Feed-through block	gray F	RFK 1/240 F S 35 <sup>*)</sup>	56.399.0055.0
	K	RFK 1/240 K S 35	56.399.0155.0
	FK	RFK 1/240 FK S 35 <sup>*)</sup>	56.399.0255.0
	FM	RFK 1/240 FM S 35 <sup>*)</sup>	56.399.1055.0
	FMK	RFK 1/240 FMK S 35 <sup>*)</sup>	56.399.1255.0

### GENERAL DATA

Width / length / height, incl. TS 7.5	see list			
Wire strip length	27 mm			
Approvals				
TECHNICAL DATA		IEC	UL	CSA
For use with insulating sleeves		EN 60947-7-1		
Cross section fine-stranded		70 - 240 mm <sup>2</sup>		
Cross section solid/stranded		70 - 240 mm <sup>2</sup>		
Cross section, AWG			0 - 500 kcmil	3/0 - 500 kcmil
Rated current		415 A	375 A	425 A
Rated voltage		1000 V	600 V	600 V
Rated impulse voltage		8 kV		
Pollution degree		3		

ACCESSORIES	Type	Part No.	Std. Pack
Cover for RFK 1 /..., yellow		AD RFK 150 - 240	27.409.5853.0
Partition / end plate	2.8mm thick	TE/RFK 1/150 - 240 PA	07.340.1053.0
Cross connector, from E-Cu	for 2 blocks	VB RFK 1/240/2	07.201.8227.0
	for 3 blocks	VB RFK 1/240/3	07.201.8327.0
	for 4 blocks	VB RFK 1/240/4	07.201.8427.0

## CONFIGURATIONS

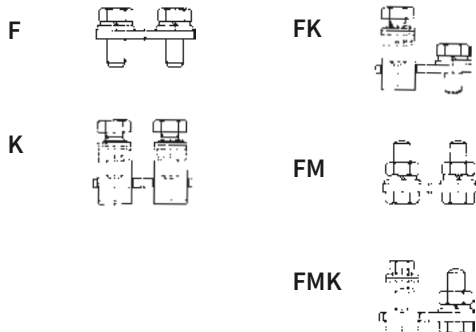

mm <sup>2</sup>	Type	Screw	Width mm	Length mm	Height, incl. TS 7.5 mm
95	F	M 10	32	92	55
	FM	M 10	32	92	65
	K, FK, FMK	M 10	32	92	78
150	F	M 12	42	92	55
	K, FK, FMK	M 12	42	92	78
185	F	M 12	42	92	55
	FM	M 12	42	92	70
240	F	M 12	42	92	55
	FM	M 12	42	92	77
	K, FK, FMK	M 12	42	92	93

# MINI BLOCKS WITH SCREW CONNECTION FOR TS 15

## WKM 2,5 / 15

- Feed-through block for mounting on TS 15
- Nominal cross section 2.5 mm<sup>2</sup>
- Ex e I/II  II 2GD IM2  
Follow the EX installation instructions on page 174



Description	Type	Part No.	Std. Pack
Feed-through block	gray	WKM 2,5/15	55.503.1053.0 100
Feed-through block	blue	WKM 2,5/15 BLAU	55.503.1053.6 100
GENERAL DATA			
Width / length / height, incl. TS 7.5	5 mm / 32 mm / 32 mm		
Wire strip length	9 mm		
Approvals	 KEMA 02 ATEX 2114 U		
TECHNICAL DATA			
	IEC	UL	CSA
	EN 60 947-7-1		
Cross section fine-stranded	0.5 – 2.5 mm <sup>2</sup>		
Cross section solid/stranded	0.5 – 4 mm <sup>2</sup>		
Cross section, AWG	22 – 14	24 – 12	
Rated current	25 A	10 A	20 A
Rated voltage	500 V	300 V	275 V
Rated impulse voltage	6 kV		
Pollution degree	3		
ACCESSORIES			
Description	Type	Part No.	Std. Pack
End plate	gray	APM 2,5 - 4/15	07.311.0853.0 10
	blue	APM 2,5 - 4/15 BLAU	07.311.0853.6 10
Partition	gray	TWM 2,5 - 4/15	07.311.1853.0 10
Cross connector with screws,	2-pole	VB WKM 2,5/15-2	Z7.215.4227.0 50
E-Cu	3-pole	VB WKM 2,5/15-3	Z7.215.4327.0 50
	up to 6-pole	VB WKM 2,5/15-6	Z7.215.4627.0 50
	60-pole	VB WKM 2,5/15 M60	Z7.215.4027.0 10
Single cover f. cross conn. with marking facility	AD VB 2,5/15 GELB 04.326.3053.8 10		
Partition plate with marking facility	TSM 2,5/15 07.311.2853.8 10		

## WKM 4 / 15

- Feed-through block for mounting on TS 15
- Nominal cross section 4 mm<sup>2</sup>
- Ex e I/II  II 2GD IM2  
Follow the EX installation instructions on page 174
- <sup>2)</sup> with/without jumper



Description	Type	Part No.	Std. Pack
Feed-through block	gray	WKM 4/15	55.504.1053.0 100
Feed-through block	blue	WKM 4/15 BLAU	55.504.1053.6 100
GENERAL DATA			
Width / length / height, incl. TS 7.5	6 mm / 32 mm / 32 mm		
Wire strip length	9 mm		
Approvals	 KEMA 02 ATEX 2114 U		
TECHNICAL DATA			
	IEC	UL	CSA
	EN 60 947-7-1		
Cross section fine-stranded	0.5 – 4 mm <sup>2</sup>		
Cross section solid/stranded	0.5 – 6 mm <sup>2</sup>		
Cross section, AWG	22 – 10	20 – 10	
Rated current	28 A	30 A	21/27 A <sup>2)</sup>
Rated voltage	500 V	600 V	275 V
Rated impulse voltage	6 kV		
Pollution degree	3		
ACCESSORIES			
Description	Type	Part No.	Std. Pack
End plate	gray	APM 2,5 - 4/15	07.311.0853.0 10
	blue	APM 2,5 - 4/15 BLAU	07.311.0853.6 10
Partition	gray	TWM 2,5 - 4/15	07.311.1853.0 10
Cross connector with screws,	2-pole	IVB WK 4 E/U-2	Z7.271.2227.0 10
E-Cu	3-pole	IVB WK 4 E/U-3	Z7.271.2327.0 10
	up to 12-pole	IVB WK 4 E/U-12	Z7.271.3227.0 10
Single cover f. cross conn. with marking facility	AD VB 4/15 GELB 04.326.2953.8 10		
Partition plate with marking facility	TSM 4/15 07.311.2953.8 10		

## WKM 4 SL / 15

- Ground block for mounting on TS 15
- Nominal cross section 4 mm<sup>2</sup>
- Ex e I/II  II 2GD IM2  
Follow the EX installation instructions on page 174



Description	Type	Part No.	Std. Pack
Ground block	green/yellow	WKM 4 SL/15	55.504.9153.0 100
GENERAL DATA			
Width / length / height, incl. TS 7.5	6 mm / 32 mm / 32 mm		
Wire strip length	9 mm		
Approvals	 KEMA 02 ATEX 2114 U		
TECHNICAL DATA			
	IEC	UL	CSA
	EN 60 947-7-2		
Cross section fine-stranded	0.5 – 4 mm <sup>2</sup>		
Cross section solid/stranded	0.5 – 6 mm <sup>2</sup>		
Cross section, AWG	22 – 14	22 – 10	
Rated current	30 A		
Rated voltage	500 V	300 V	
Rated impulse voltage	6 kV		
Pollution degree	3		
ACCESSORIES			
Description	Type	Part No.	Std. Pack
End plate	APM 4 SL/15 07.311.0753.0 10		

## WKM 2,5 F1/15

- Feed-through block with solder connection for mounting on TS 15
- Nominal cross section 2.5 mm<sup>2</sup>
- The terminal blocks of series WKM 2,5 F1/15 and WKM 2,5 F2/15 must be mounted alternately in order to maintain the required air and creepage distances for the indicated rated voltage.

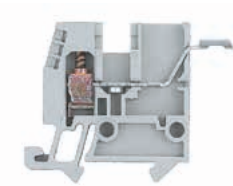

Description	Type	Part No.	Std. Pack
Feed-through block	gray WKM 2,5 F1/15	55.503.1253.0	100
<b>GENERAL DATA</b>			
Width / length / height, incl. TS 7.5	5 mm / 32 mm / 32 mm		
Wire strip length	9 mm		
Approvals			
<b>TECHNICAL DATA</b>		<b>IEC</b>	<b>UL</b> <b>CSA</b>
		EN 60 947-7-1	
Cross section fine-stranded	0.5 – 2.5 mm <sup>2</sup>		
Cross section solid/stranded	0.5 – 4 mm <sup>2</sup>		
Cross section, AWG			
Rated current	24 A		
Rated voltage	500 V		
Rated impulse voltage	6 kV		
Pollution degree	3		
<b>ACCESSORIES</b>		<b>Type</b>	<b>Part No.</b> <b>Std. Pack</b>
End plate	gray	APM 2,5 F,15	07.311.0653.0      10
Cross connector with screws,	2-pole	VB WKM 2,5/15-2	Z7.215.4227.0      50
E-Cu	3-pole	VB WKM 2,5/15-3	Z7.215.4327.0      50
	up to 6-pole	VB WKM 2,5/15-6	Z7.215.4627.0      50
	60-pole	VB WKM 2,5/15 M60	Z7.215.4027.0      10
Single cover f. cross conn. with marking facility		AD VB 2,5/15 GELB	04.326.3053.8      10
Partition plate with marking facility yellow		TSM 2,5/15	07.311.2853.8      10

## WKM 2,5 F2/15

- Feed-through block solder connection for mounting on TS 15
- Nominal cross section 2.5 mm<sup>2</sup>
- The terminal blocks of series WKM 2,5 F1/15 and WKM 2,5 F2/15 must be mounted alternately in order to maintain the required air and creepage distances for the indicated rated voltage.

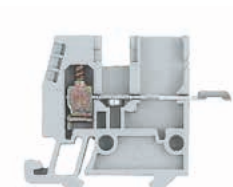

Description	Type	Part No.	Std. Pack
Feed-through block	gray WKM 2,5 F2/15	55.503.1353.0	100
<b>GENERAL DATA</b>			
Width / length / height, incl. TS 7.5	5 mm / 32 mm / 32 mm		
Wire strip length	9 mm		
Approvals			
<b>TECHNICAL DATA</b>		<b>IEC</b>	<b>UL</b> <b>CSA</b>
		EN 60 947-7-1	
Cross section fine-stranded	0.5 – 2.5 mm <sup>2</sup>		
Cross section solid/stranded	0.5 – 4 mm <sup>2</sup>		
Cross section, AWG			
Rated current	24 A		
Rated voltage	500 V		
Rated impulse voltage	6 kV		
Pollution degree	3		
<b>ACCESSORIES</b>		<b>Type</b>	<b>Part No.</b> <b>Std. Pack</b>
End plate	gray	APM 2,5 F,15	07.311.0653.0      10
Cross connector with screws,	2-pole	VB WKM 2,5/15-2	Z7.215.4227.0      50
E-Cu	3-pole	VB WKM 2,5/15-3	Z7.215.4327.0      50
	up to 6-pole	VB WKM 2,5/15-6	Z7.215.4627.0      50
	60-pole	VB WKM 2,5/15 M60	Z7.215.4027.0      10
Single cover f. cross conn. with marking facility		AD VB 2,5/15 GELB	04.326.3053.8      10
Partition plate with marking facility yellow		TSM 2,5/15	07.311.2853.8      10







# SELOS BIT

## TERMINAL BLOCKS FOR **ELECTRICAL** INSTALLATIONS WITH SCREW CONNECTION

Reliable connection, proven concept! selos – these are terminal blocks with screw connection, solid and functional, known worldwide, and used millions of times over.

The selos series combines the advantages of the classic screw connection with modern connection technology, with the focus on customer benefits and increased efficiency in wiring and logistics.

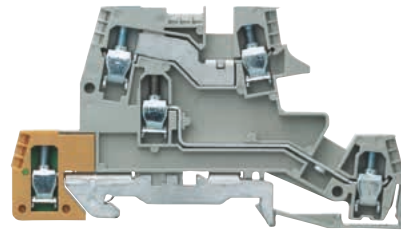
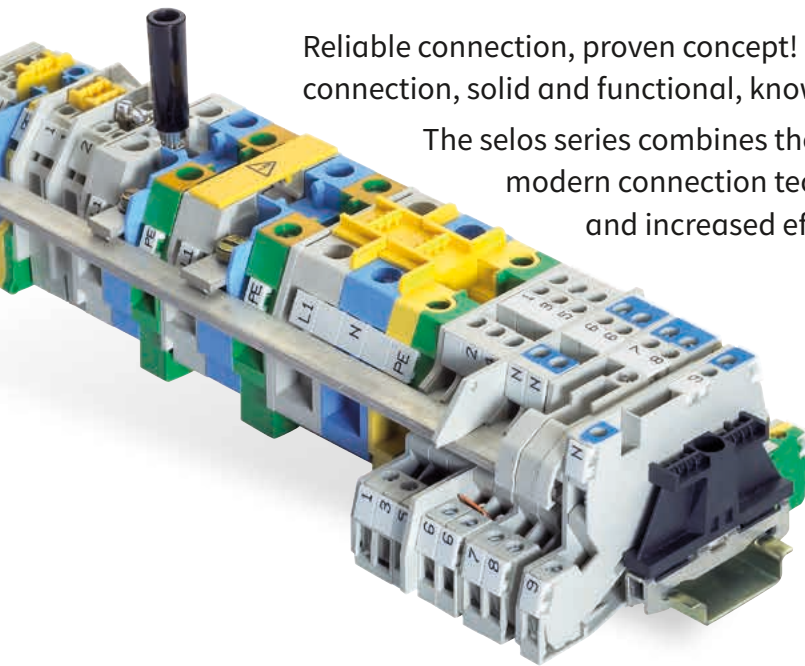

### SPACE-SAVING WIRING

- Clear wiring and assignment of electrical circuits through three-tier design in 6 mm assembly width
- Neutral conductor, phase feed-through, and ground connection in just one terminal
- Safety and convenience through switchable N disconnect function

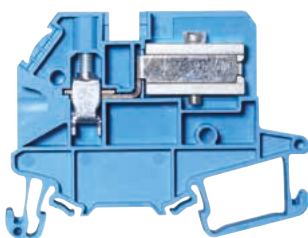

### SAFE AND MAINTENANCE-FREE CONNECTION

- Stable terminal body design with single-part thread
- Multi-wire connection
- Connect with and without wire end ferrule
- Safety and operating convenience even with N-separation using screwable slide-gate valve

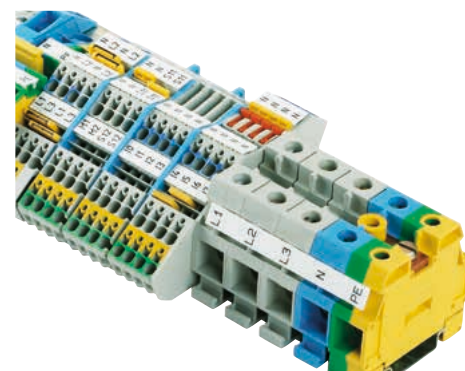

### COMBINABLE IN THE SYSTEM

- Problem-free combination of installation terminals with other Wieland terminal blocks, also with different connection equipment
- For example:
  - Circuit wiring with compact spring-force device fasis BIT
  - Power feed with proven selos screws
- Low storage and logistics expense due to uniform accessories

# NEUTRAL DISCONNECT TERMINALS FOR INSTALLATION DISTRIBUTION BOARDS WITH SCREW CONNECTION

## WT 4 NT

- Neutral disconnect block with screw connection for mounting on TS 35
- Nominal cross section 4 mm<sup>2</sup>

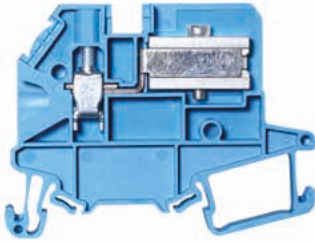

Description	Type	Part.No.	Std. Pack	
Neutral disconnect terminal	blue WT 4 NT	58.504.6155.0	100	
<b>GENERAL DATA</b>				
Width / length / height, incl. TS 7.5	6 mm / 62.6 mm / 48.6 mm			
Wire strip length	9 mm			
Approvals				
<b>TECHNICAL DATA</b>				
	<b>IEC</b>	<b>UL</b>	<b>CSA</b>	<b>EX</b>
	EN 60 947-7-2			
Cross section fine-stranded	0.14-6 mm <sup>2</sup>			
Cross section solid/stranded	0.14-6 mm <sup>2</sup>			
Cross-section, AWG				
Rated current	32 A			
Rated voltage	400 V			
Rated impulse voltage	6 kV			
Pollution degree	3			
<b>ACCESSORIES</b>				
	<b>Type</b>	<b>Part.No.</b>	<b>Std. Pack</b>	
End plate	AP WT 4 NT	07.313.4355.0	1	
Busbar	9813 M 10X3 1000MM	98.290.0000.0	1	
	9813 M SN 10X3 1000MM	98.290.1000.0	1	
Connection clamp for busbar	WAK16/2 BL/V0	30.494.3021.6	100	
Connection clamp for busbar	WAK35/2 BL/V0	30.494.4021.6	100	
Connection clamp for busbar	WAK35/2	30.494.4121.0	50	

## WKI 10 ETK

- Neutral disconnect block with screw connection for mounting on TS 35 and TS 32
- Nominal cross section 10 mm<sup>2</sup>

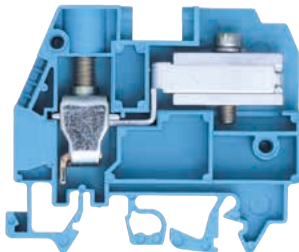

Description	Type	Part.No.	Std. Pack	
Neutral disconnect terminal	blue WKI 10 ETK/U/V0	57.510.8255.0	50	
<b>GENERAL DATA</b>				
Width / length / height, incl. TS 7.5	10 mm / 58 mm / 51.5 mm			
Wire strip length	13 mm			
Approvals				
<b>TECHNICAL DATA</b>				
	<b>IEC</b>	<b>UL</b>	<b>CSA</b>	<b>EX</b>
	EN 60 947-7-2			
Cross section fine-stranded	1-10 mm <sup>2</sup>			
Cross section solid/stranded	1-16 mm <sup>2</sup>			
Cross-section, AWG	16-6 AWG			
Rated current	45 A			
Rated voltage	400 V			
Rated impulse voltage	6 kV			
Pollution degree	3			
<b>ACCESSORIES</b>				
	<b>Type</b>	<b>Part.No.</b>	<b>Std. Pack</b>	
End plate	API 10-16 ETK/1/V0	07.312.1955.0	10	
Busbar	9813 M 10X3 1000MM	98.290.0000.0	1	
	9813 M SN 10X3 1000MM	98.290.1000.0	1	
Connection clamp for busbar	WAK16/2 BL/V0	30.494.3021.6	100	
Connection clamp for busbar	WAK35/2 BL/V0	30.494.4021.6	100	
Connection clamp for busbar	WAK35/2	30.494.4121.0	50	

## WKI 16 ETK

- Neutral disconnect block with screw connection for mounting on TS 35 and TS 32
- Nominal cross section 16 mm<sup>2</sup>

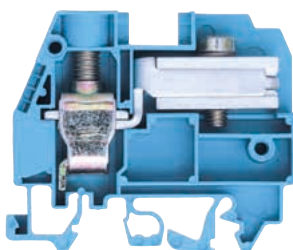

Description	Type	Part.No.	Std. Pack	
Neutral disconnect terminal	blue WKI 16 ETK/U/V0	57.516.8255.0	50	
<b>GENERAL DATA</b>				
Width / length / height, incl. TS 7.5	12 mm / 58 mm / 51.5 mm			
Wire strip length	15 mm			
Approvals				
<b>TECHNICAL DATA</b>				
	<b>IEC</b>	<b>UL</b>	<b>CSA</b>	<b>EX</b>
	EN 60 947-7-2			
Cross section fine-stranded	1-16 mm <sup>2</sup>			
Cross section solid/stranded	1-25 mm <sup>2</sup>			
Cross-section, AWG	14-4 AWG			
Rated current	62 A			
Rated voltage	400 V			
Rated impulse voltage	6 kV			
Pollution degree	3			
<b>ACCESSORIES</b>				
	<b>Type</b>	<b>Part.No.</b>	<b>Std. Pack</b>	
End plate	API 10-16 ETK/1/V0	07.312.1955.0	10	
Busbar	9813 M 10X3 1000MM	98.290.0000.0	1	
	9813 M SN 10X3 1000MM	98.290.1000.0	1	
Connection clamp for busbar	WAK16/2 BL/V0	30.494.3021.6	100	
Connection clamp for busbar	WAK35/2 BL/V0	30.494.4021.6	100	
Connection clamp for busbar	WAK35/2	30.494.4121.0	50	

# TERMINAL BLOCKS FOR INSTALLATION DISTRIBUTION BOARDS IN COMPACT DESIGN



## WKI 10

- Feed-through block with screw connection for mounting on TS 35 and TS 32
- Nominal cross section 10 mm<sup>2</sup>

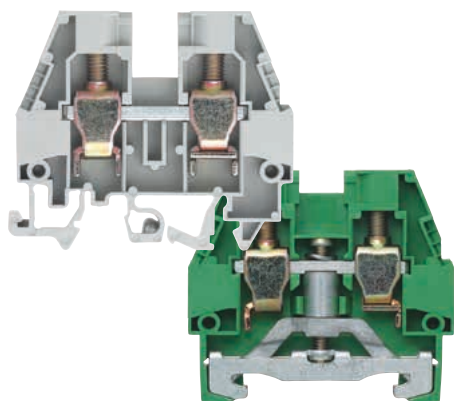

Description	Type	Part.No.	Std. Pack	
Feed-through terminal	gray	WKI 10 / U/V0	57.510.1155.0	50
	blue	WKI 10 / U BLAU/V0	57.510.1155.6	50
Feed-through terminal block green/yellow	WKI 10 SL / 35/V0	56.510.9255.0	50	

GENERAL DATA				
Width / length / height, incl. TS 7.5	10 mm / 58 mm / 51,5 mm			
Wire strip length	18 mm			
Approvals				

TECHNICAL DATA	IEC	UL	CSA	EX
	EN 60 947-7-1			
Cross section fine-stranded	1-10 mm <sup>2</sup>			
Cross section solid/stranded	1.5-16 mm <sup>2</sup>			
Cross-section, AWG		16-6 AWG	16-6 AWG	
Rated current	57 A	65 A	70 A	
Rated voltage	400 V	600 V	600 V	
Rated impulse voltage	6 kV			
Pollution degree	3			

ACCESSORIES	Type	Part.No.	Std. Pack	
End plate	API 10 - 16/V0	07.311.9455.0	10	
Insulated jumper bar	2-pole	IVBWKN10 - 2	27.283.2227.0	10
	3-pole	IVBWKN10 - 3	27.283.2327.0	10
	4-pole	IVBWKN10 - 4	27.283.2427.0	10
	5-pole	IVBWKN10 - 5	27.283.2527.0	10

## WKI 16

- Feed-through block with screw connection for mounting on TS 35 and TS 32
- Nominal cross section 16 mm<sup>2</sup>

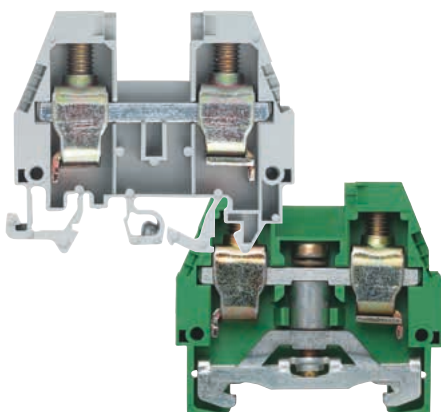

Description	Type	Part.No.	Std. Pack	
Feed-through terminal	gray	WKI 16 / U/V0	57.516.1155.0	50
	blue	WKI 16 / U BLAU/V0	57.516.1155.6	50
Feed-through terminal block green/yellow	WKI 16 SL / 35/V0	56.516.9255.0	50	

GENERAL DATA				
Width / length / height, incl. TS 7.5	12 mm / 58 mm / 51,5 mm			
Wire strip length	16 mm			
Approvals				

TECHNICAL DATA	IEC	UL	CSA	EX
	EN 60 947-7-1			
Cross section fine-stranded	1-16 mm <sup>2</sup>			
Cross section solid/stranded	1.5-25 mm <sup>2</sup>			
Cross-section, AWG		12-4 AWG	14-4 AWG	
Rated current	76 A	65 / 90 A	95 A	
Rated voltage	400 V	600 V	600 V	
Rated impulse voltage	6 kV			
Pollution degree	3			

ACCESSORIES	Type	Part.No.	Std. Pack	
End plate	API 10 - 16/V0	07.311.9455.0	10	
Insulated jumper bar	2-pole	IVB WKI16- 2	27.284.9227.0	10
	3-pole	IVB WKI16- 3	27.284.9327.0	10
	4-pole	IVB WKI16- 4	27.284.9427.0	10
	5-pole	IVB WKI16- 5	27.284.9527.0	10

## WKI 35

- Feed-through block with screw connection for mounting on TS 35 and TS 32
- Nominal cross section 35 mm<sup>2</sup>

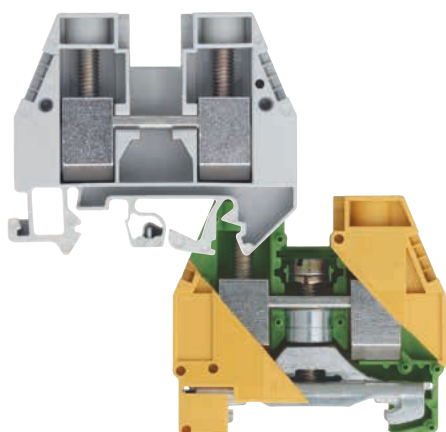

Description	Type	Part.No.	Std. Pack	
Feed-through terminal	gray	WKI 35 / U/V0	57.535.1155.0	20
	blue	WKI 35 / U BLAU/V0	57.535.1155.6	20
Feed-through terminal block green/yellow	WKI 35 SL / 35/V0	56.535.9255.0	20	

GENERAL DATA				
Width / length / height, incl. TS 7.5	16 mm / 58 mm / 51,5 mm			
Wire strip length	13 mm			
Approvals				

TECHNICAL DATA	IEC	UL	CSA	EX
	EN 60 947-7-1			
Cross section fine-stranded	6-35 mm <sup>2</sup>			
Cross section solid/stranded	6-50 mm <sup>2</sup>			
Cross-section, AWG		10-2 AWG	10-2 AWG	
Rated current	125 A	95 A	110 A	
Rated voltage	400 V	600 V	600 V	
Rated impulse voltage	6 kV			
Pollution degree	3			

ACCESSORIES	Type	Part.No.	Std. Pack	
End plate	API 35/V0	07.311.8855.0	10	
Insulated jumper bar	2-pole	IVBWKI35 - 2	27.285.4227.0	5
	3-pole	IVBWKI35 - 3	27.285.4327.0	5
	4-pole	IVBWKI35 - 4	27.285.4427.0	5
	5-pole	IVBWKI35 - 5	27.285.4527.0	5

# MULTI-TIER TERMINALS FOR INSTALLATION DISTRIBUTION BOARDS WITH SCREW CONNECTION

## WKI 4 DU

### WKI 4 D-D

- Installation multi-tier terminal with screw connection for mounting on TS 35
- Nominal cross section 4 mm<sup>2</sup>
- Model DU: one busbar below

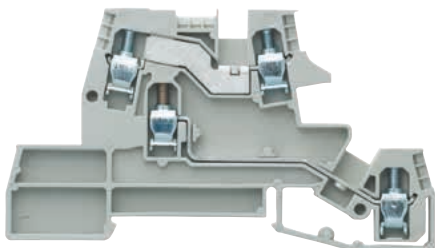

Description	Type	Part.No.	Std. Pack
Installation rail terminal blocks	WKI 4 DU /V0	56.404.9655.0	50
Installation rail terminal blocks	WKI 4 D-D /V0	56.404.9755.0	50

GENERAL DATA				
Width / length / height, incl. TS 7.5	6 mm / 90 mm / 51.5 mm			
Wire strip length	7 mm			
Approvals				
TECHNICAL DATA				
	IEC	UL	CSA	EX
	EN 60 947-7-1			
Cross section fine-stranded	0.5-4 mm <sup>2</sup>			
Cross section solid/stranded	0.5 - 6 mm <sup>2</sup>			
Cross-section, AWG		22-10 AWG	22-10 AWG	
Rated current	26 A	24 A	25 A	
Rated voltage	400 V	300 V	300 V	
Rated impulse voltage	6 kV			
Pollution degree	3			
ACCESSORIES				
	Type	Part.No.	Std. Pack	
End plate	API 4/2/V0	07.311.6555.0	10	
Partition	TWI 4/V0	07.311.6955.0	10	
Jumper bar	2-pole 9703 / 6- 2	Z7.211.0227.0	50	
	5-pole 9703 / 6- 5	Z7.211.0527.0	50	
	insulated 12-pole	IVB WKI 4-12	Z7.271.5227.0 10	
	sold by the meter 70-pole	9703 / 6 M-70	Z7.211.0027.0 10	

## WKI 4 D-D-SL

### WKI 4 N-D-SL

- Installation multi-tier terminal with screw connection for mounting on TS 35
- Nominal cross section 4 mm<sup>2</sup>

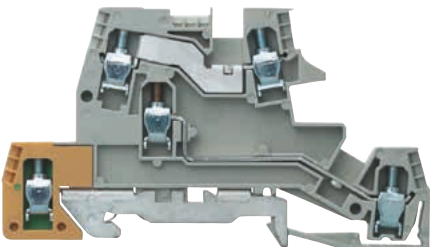

Description	Type	Part.No.	Std. Pack
Installation rail terminal blocks	WKI 4 D-D-SL /V0	56.404.9855.0	50
Installation rail terminal blocks	WKI 4 N-D-SL /V0	56.404.9455.0	50

GENERAL DATA				
Width / length / height, incl. TS 7.5	6 mm / 90 mm / 51.5 mm			
Wire strip length	7 mm			
Approvals				
TECHNICAL DATA				
	IEC	UL	CSA	EX
	EN 60 947-7-1			
Cross section fine-stranded	0.5-4 mm <sup>2</sup>			
Cross section solid/stranded	0.5 - 6 mm <sup>2</sup>			
Cross-section, AWG		22-10 AWG	22-10 AWG	
Rated current	26 A	24 A	25 A	
Rated voltage	400 V	300 V	300 V	
Rated impulse voltage	6 kV			
Pollution degree	3			
ACCESSORIES				
	Type	Part.No.	Std. Pack	
End plate	API 4/2/V0	07.311.6555.0	10	
Partition	TWI 4/V0	07.311.6955.0	10	
Jumper bar	2-pole 9703 / 6- 2	Z7.211.0227.0	50	
	5-pole 9703 / 6- 5	Z7.211.0527.0	50	
	insulated 12-pole	IVB WKI 4-12	Z7.271.5227.0 10	
	sold by the meter 70-pole	9703 / 6 M-70	Z7.211.0027.0 10	

## WKI 4 NT-D-SL

- Installation multi-tier terminal with screw connection for mounting on TS 35
- Nominal cross section 4 mm<sup>2</sup>

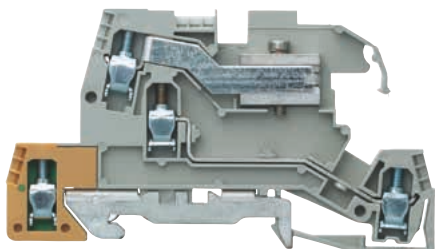

Description	Type	Part.No.	Std. Pack
Installation rail terminal blocks	WKI 4 NT -D-SL /V0	56.404.9555.0	50
	WKI 4 NT -D-SL GL/V0	56.404.9255.0	50

GENERAL DATA				
Width / length / height, incl. TS 7.5	6 mm / 90 mm / 51.5 mm			
Wire strip length	7 mm			
Approvals				
TECHNICAL DATA				
	IEC	UL	CSA	EX
	EN 60 947-7-1			
Cross section fine-stranded	0.5-4 mm <sup>2</sup>			
Cross section solid/stranded	0.5 - 6 mm <sup>2</sup>			
Cross-section, AWG		22-10 AWG	22-10 AWG	
Rated current	26 A	24 A	25 A	
Rated voltage	400 V	300 V	300 V	
Rated impulse voltage	6 kV			
Pollution degree	3			
ACCESSORIES				
	Type	Part.No.	Std. Pack	
End plate	API 4/2/V0	07.311.6555.0	10	
Jumper bar	2-pole 9703 / 6- 2	Z7.211.0227.0	50	
	3-pole 9703 / 6- 3	Z7.211.0327.0	50	
	insulated 12-pole	IVB WKI 4-12	Z7.271.5227.0 10	
	sold by the meter 70-pole	9703 / 6 M-70	Z7.211.0027.0 10	
Busbar	9813 M 10X 3 1000MM	98.290.0000.0	1	
	9813 M SN 10X3 1000MM	98.290.1000.0	1	



### WKI 4 NTN-D-SL

- Installation multi-tier terminal with screw connection for mounting on TS 35
- Nominal cross section 4 mm<sup>2</sup>
- The busbar cannot pass by on the outside. These two terminals should therefore be placed at the start or end of a terminal group.

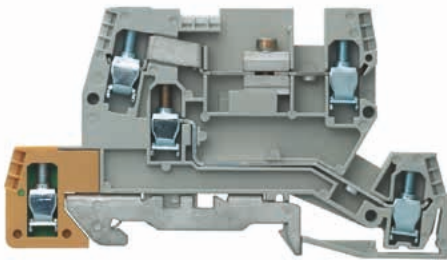

Description	Type	Part.No.	Std. Pack
Installation rail terminal blocks	WKI 4 NTN-D-SL /V0	56.404.9155.0	50
<b>GENERAL DATA</b>			
Width / length / height, incl. TS 7.5	6 mm / 90 mm / 51.5 mm		
Wire strip length	7 mm		
Approvals			
<b>TECHNICAL DATA</b>			
	<b>IEC</b>	<b>UL</b>	<b>CSA</b> <b>EX</b>
	EN 60 947-7-1		
Cross section fine-stranded	0.5-4 mm <sup>2</sup>		
Cross section solid/stranded	0.5 - 6 mm <sup>2</sup>		
Cross-section, AWG		22-10 AWG	22-10 AWG
Rated current	26 A	24 A	25 A
Rated voltage	400 V	300 V	300 V
Rated impulse voltage	6 kV		
Pollution degree	3		
<b>ACCESSORIES</b>			
	<b>Type</b>	<b>Part.No.</b>	<b>Std. Pack</b>
End plate	API 4/3/V0	07.311.6855.0	10
Jumper bar	2-pole 9703 / 6- 2	Z7.211.0227.0	50
	3-pole 9703 / 6- 3	Z7.211.0327.0	50
	insulated 12-pole IVB WKI 4-12	Z7.271.5227.0	10
	sold by the meter 70-pole 9703 / 6 M-70	Z7.211.0027.0	10

### WKI 4 TKG-D-SL

- Multi-tier fuse terminal with screw connection for mounting on TS 35
- Nominal cross section 4 mm<sup>2</sup>
- The busbar cannot pass by on the outside. The terminal should therefore be placed at the start or end of a terminal group.

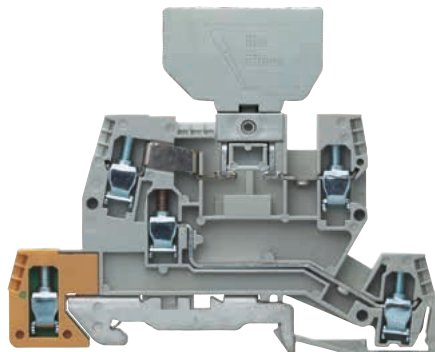

Description	Type	Part.No.	Std. Pack
Installation rail terminal blocks	WKI 4 TKG-D-SL /V0	56.404.8855.0	50
<b>GENERAL DATA</b>			
Width / length / height, incl. TS 7.5	6 mm / 90 mm / 51.5 mm		
Wire strip length	7 mm		
Approvals			
<b>TECHNICAL DATA</b>			
	<b>IEC</b>	<b>UL</b>	<b>CSA</b> <b>EX</b>
	EN 60 947-7-1		
Cross section fine-stranded	0.5-4 mm <sup>2</sup>		
Cross section solid/stranded	0.5 - 6 mm <sup>2</sup>		
Cross-section, AWG		22-10 AWG	22-10 AWG
Rated current	26 A	12 A	12 A
Rated voltage	400 V	300 V	300 V
Rated impulse voltage	6 kV		
Pollution degree	3		
<b>ACCESSORIES</b>			
	<b>Type</b>	<b>Part.No.</b>	<b>Std. Pack</b>
End plate	API 4/3/V0	07.311.6855.0	10
Jumper bar	2-pole 9703 / 6- 2	Z7.211.0227.0	50
	5-pole 9703 / 6- 5	Z7.211.0527.0	50
	insulated 12-pole IVB WKI 4-12	Z7.271.5227.0	10
	sold by the meter 70-pole 9703 / 6 M-70	Z7.211.0027.0	10

### FUSE HOLDER

- Fuse holder for built-in in WKI 4 TKG-D-SL
- Nominal current in accordance with VDE 0820 T2/ EN 60 127-2 with use of 1.6 W – 6.3 A, for individual terminal – 4 A with terminals directly next to each other
- Voltage and current are determined through the installed lamp display and the fuse insert used.



Description	Type	Part.No.	Std. Pack
Fuse holder for fuse 5 x 20	Si ST	Z1.299.4055.0	10
Fuse holder with indicator (24 V)	Si ST LED	Z1.299.4155.0	10
Fuse holder with indicator (220 V)	Si ST GL	Z1.299.4255.0	10



# SELOS CLASSIC

## DIN RAIL TERMINAL BLOCKS WITH SCREW CONNECTION, TYPE 9700 A.. S35

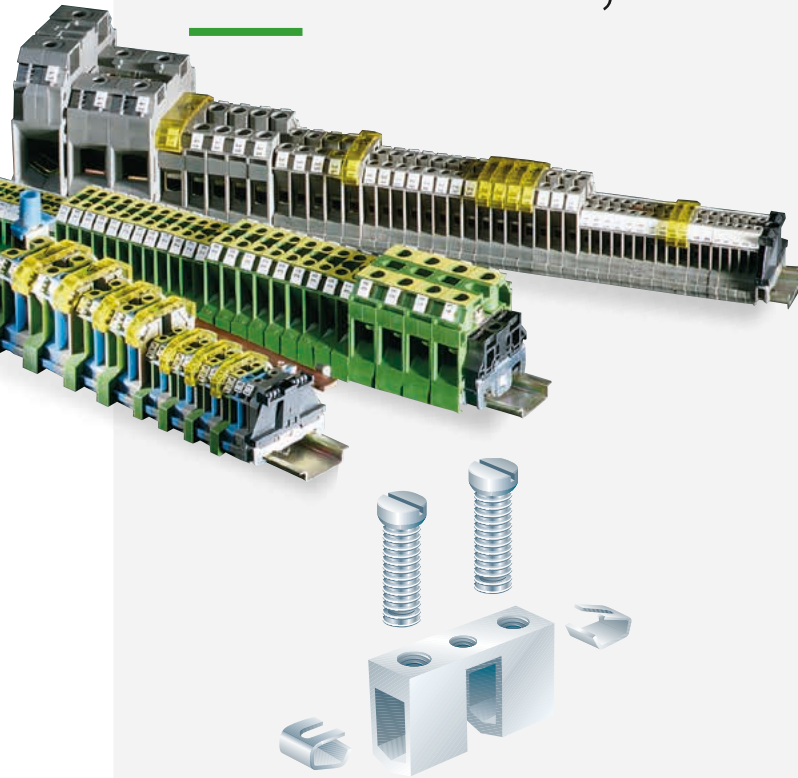

The selos CLASSIC series offers the highest-quality connecting technology. Thanks to its unique clamping body design, aluminum or copper wire connections are long lasting.

The product line includes feed-through and ground blocks for wires up to 50 mm<sup>2</sup>.

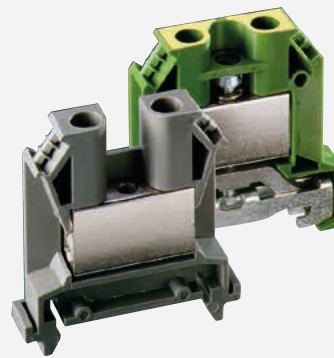

### HIGH-QUALITY SCREW CONNECTION TECHNOLOGY

- Steel free clamping body
  - Increased corrosion resistance
  - Extruded clamping body, nickel-plated brass
- Low contact resistance
  - Clamping body has similar physical and chemical characteristics as the conductor
  - One piece clamping body/current bar

### WIDE CONNECTION RANGE

- Connection range 0.5 – 50 mm<sup>2</sup>  
Solid, fine-stranded and stranded wires can be connected to the terminal blocks of selosCLASSIC without ferrules, as all block sizes have wire protection.



### CONNECTION OF ALUMINUM WIRES POSSIBLE

The following always applies to Al wires in the selos CLASSIC:

- After being stripped, the ends of the wires must be scraped clean, e.g. with a blade and immediately coated with acid-free grease to prevent further oxidation.
- The terminals should be tightened to a torque that is approx. 20 % higher than the nominal torque stated for the clamping screw.
- The selos CLASSIC is suitable for solid and stranded aluminum wires.
- With solid wires there is no need to retighten the clamping screws. With stranded wires we recommend retightening within the first 2 years after installation to improve the quality of the contact.

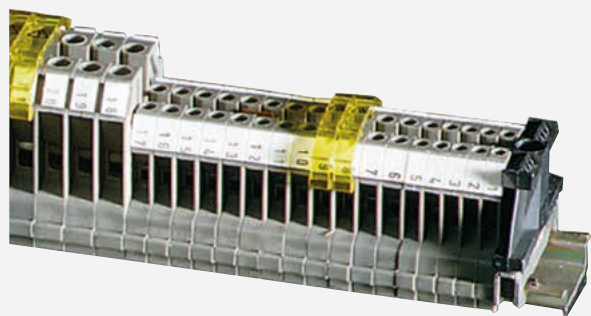

### COMPACT DESIGN

- **Save space on the rail**  
selos CLASSIC offers higher density due to the wire size and terminal block pitch:

Connection range	Pitch
2,5 mm <sup>2</sup>	5 mm
4 mm <sup>2</sup>	6 mm
10 mm <sup>2</sup>	8 mm
16 mm <sup>2</sup>	10 mm
25 mm <sup>2</sup>	12 mm
35 mm <sup>2</sup>	16 mm



# FEED-THROUGH BLOCKS WITH SCREW CONNECTION, TYPE 9700 A.. S35



## 9700 A/5 S35

- Feed-through block for mounting on TS 35
- Nominal cross section 2,5 mm<sup>2</sup>



Description	Type	Part No.	Std. Pack
Feed-through block	gray 9700 A/5 S35	54.003.7553.0	100
Feed-through block, (Ex)i	blue 9700 A/5 S35 BLAU	54.003.7553.6	100
<b>GENERAL DATA</b>			
Width / length / height, incl. TS 7.5	5 mm / 47 mm / 38 mm		
Wire strip length	9 mm		
Approvals			
<b>TECHNICAL DATA</b>			
Ratings for use of insulating sleeves	EN 60 947-7-1		
Cross section fine-stranded	0.5 – 2.5 mm <sup>2</sup>		
Cross section solid/stranded	0.5 – 4 mm <sup>2</sup>		
Cross section, AWG		18 – 12	22 – 12
Rated current	24 A	20/30 A	25 A
Rated voltage	800 V	600 V	600 V
Rated impulse voltage	8 kV		
Pollution degree	3		
<b>ACCESSORIES</b>			
End plate, gray	9701/6	07.310.3153.0	10
Partition, gray	9702/6	07.310.3453.0	10
Cross connector with screws, E-Cu, uninsulated	2-pole 9703/5-2	27.215.0227.0	50
	3-pole 9703/5-3	27.215.0327.0	50
	4-pole 9703/5-4	27.215.0427.0	50
	5-pole 9703/5-5	27.215.0527.0	50
	6-pole 9703/5-6	27.215.0627.0	50
	Cut-to-order strip 0,6 m long 9703/5-M	27.215.0027.0	10
2-pole switchable jumper		27.269.3523.0	50
Adapter for test plug	9011 D	05.508.8921.0	10
Cover with warn. symbol for 1 block	yellow	04.325.1656.0	10

## 9700 A/6 S35

- Feed-through block for mounting on TS 35
- Nominal cross section 4 mm<sup>2</sup>



Description	Type	Part No.	Std. Pack
Feed-through block	gray 9700 A/6 S35	54.004.7553.0	100
Feed-through block, (Ex)i	blue 9700 A/6 S35 BLAU	54.004.7553.6	100
<b>GENERAL DATA</b>			
Width / length / height, incl. TS 7.5	6 mm / 47 mm / 38 mm		
Wire strip length	9 mm		
Approvals			
<b>TECHNICAL DATA</b>			
Ratings for use of insulating sleeves	EN 60 947-7-1		
Cross section fine-stranded	0.5 – 4 mm <sup>2</sup>		
Cross section solid/stranded	0.5 – 6 mm <sup>2</sup>		
Cross section, AWG		18 – 10	22 – 10
Rated current	32 A	30/30 A	35 A
Rated voltage	800 V	600 V	600 V
Rated impulse voltage	8 kV		
Pollution degree	3		
<b>ACCESSORIES</b>			
End plate, gray	9701/6	07.310.3153.0	10
Partition, gray	9702/6	07.310.3453.0	10
Cross connector with screws, E-Cu, uninsulated	2-pole 9703/6-2	27.211.0227.0	50
	3-pole 9703/6-3	27.211.0327.0	50
	4-pole 9703/6-4	27.211.0427.0	50
	5-pole 9703/6-5	27.211.0527.0	50
	6-pole 9703/6-6	27.211.0627.0	50
	Cut-to-order strip 0,6 m long 9703/6-M	27.211.0027.0	10
2-pole switchable jumper		27.269.2923.0	50
Adapter for test plug	9011 C	05.508.8821.0	10
Cover with warn. symbol for 1 block	yellow	04.325.1056.0	10

# FEED-THROUGH BLOCKS WITH SCREW CONNECTION, TYPE 9700 A.. S35

## 9700 A/8 S35

- Feed-through block for mounting on TS 35
- Nominal cross section 10 mm<sup>2</sup>



Description	Type	Part No.	Std. Pack
Feed-through block	gray	9700 A/8 S 35	54.010.7553.0 100
Feed-through block, (Ex)i	blue	9700 A/8 S 35 BLAU	54.010.7553.6 100
<b>GENERAL DATA</b>			
Width / length / height, incl. TS 7.5	8 mm / 47 mm / 48 mm		
Wire strip length	12 mm		
Approvals			
<b>TECHNICAL DATA</b>		<b>IEC</b>	<b>UL</b> <b>CSA</b>
		EN 60 947-7-1	
Cross section fine-stranded	1 – 10 mm <sup>2</sup>		
Cross section solid/stranded	1 – 10 mm <sup>2</sup>		
Cross section, AWG		18 – 8	18 – 8
Rated current	57 A	50/50 A	55 A
Rated voltage	800 V	600 V	600 V
Rated impulse voltage	8 kV		
Pollution degree	3		
<b>ACCESSORIES</b>		<b>Type</b>	<b>Part No.</b> <b>Std. Pack</b>
End plate	gray	9701/8	07.310.3253.0 10
Partition	gray	9702/8	07.310.3553.0 10
Cross connector with screws, E-Cu, uninsulated	2-pole	9703/8-2	Z7.212.0227.0 50
	3-pole	9703/8-3	Z7.212.0327.0 50
	4-pole	9703/8-4	Z7.212.0427.0 50
	5-pole	9703/8-5	Z7.212.0527.0 50
	6-pole	9703/8-6	Z7.212.0627.0 50
2-pole switchable jumper			Z7.269.3023.0 50
Adapter for test plug		9011 B	05.508.3221.0 10
Cover with warn. symbol for 1 block	yellow		04.325.1156.0 10
Rapid mounting tool			05.593.5953.0 10

## 9700 A/10 S35

- Feed-through block for mounting on TS 35
- Nominal cross section 16 mm<sup>2</sup>



Description	Type	Part No.	Std. Pack
Feed-through block	gray	9700 A/10 S 35	54.016.7553.0 100
Feed-through block, (Ex)i	blue	9700 A/10 S 35 BLAU	54.016.7553.6 100
<b>GENERAL DATA</b>			
Width / length / height, incl. TS 7.5	10 mm / 49 mm / 51 mm		
Wire strip length	15 mm		
Approvals			
<b>TECHNICAL DATA</b>		<b>IEC</b>	<b>UL</b> <b>CSA</b>
		EN 60 947-7-1	
Cross section fine-stranded	1.5 – 16 mm <sup>2</sup>		
Cross section solid/stranded	1.5 – 16 mm <sup>2</sup>		
Cross section, AWG		18 – 6	18 – 6
Rated current	76 A	65/70 A	70 A
Rated voltage	800 V	600 V	600 V
Rated impulse voltage	8 kV		
Pollution degree	3		
<b>ACCESSORIES</b>		<b>Type</b>	<b>Part No.</b> <b>Std. Pack</b>
End plate	gray	9701/10	07.310.3953.0 10
Partition	gray	9702/10	07.310.4053.0 10
Cross connector with screws, E-Cu, uninsulated	2-pole	9703/10-2	Z7.214.0227.0 50
	3-pole	9703/10-3	Z7.214.0327.0 50
	4-pole	9703/10-4	Z7.214.0427.0 50
	5-pole	9703/10-5	Z7.214.0527.0 50
	6-pole	9703/10-6	Z7.214.0627.0 50
2-pole switchable jumper			Z7.269.3123.0 50
Adapter for test plug		9011 A	05.508.3121.0 10
Cover with warn. symbol for 1 block	yellow		04.325.1256.0 10

### 9700 A/12 S35

- Feed-through block for mounting on TS 35
- Nominal cross section 25 mm<sup>2</sup>

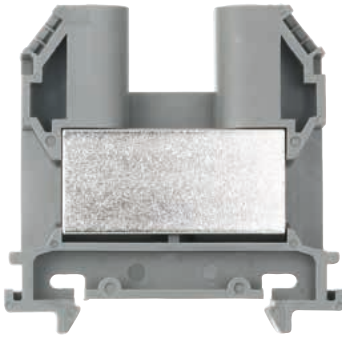

Description	Type	Part No.	Std. Pack
Feed-through block	gray	9700 A/12 S 35	54.025.7553.0
Feed-through block, (Ex)i	blue	9700 A/12 S 35 BLAU	54.025.7553.6

#### GENERAL DATA

Width / length / height, incl. TS 7.5	12 mm / 59 mm / 58 mm
Wire strip length	20 mm
Approvals	

#### TECHNICAL DATA

	IEC	UL	CSA
	EN 60 947-7-1		
Cross section fine-stranded	2.5 – 25 mm <sup>2</sup>		
Cross section solid/stranded	2.5 – 35 mm <sup>2</sup>		
Cross section, AWG		14–4	14–4
Rated current	101 A	85/100 A	100 A
Rated voltage	800 V	600 V	600 V
Rated impulse voltage	8 kV		
Pollution degree	3		

#### ACCESSORIES

	Type	Part No.	Std. Pack
End plate	gray	9701/12	07.310.3353.0
Partition	gray	9702/12	07.310.3653.0
Cross connector with screws, E-Cu, uninsulated	2-pole	9703/12-2	Z7.213.0227.0
	3-pole	9703/12-3	Z7.213.0327.0
	4-pole	9703/12-4	Z7.213.0427.0
	5-pole	9703/12-5	Z7.213.0527.0
	6-pole	9703/12-6	Z7.213.0627.0
2-pole switchable jumper		Z7.269.3223.0	50
Adapter for test plug		05.508.6521.0	10
Cover with warn. symbol for 1 block	yellow	04.325.1356.0	10

### 9700 A/16 S35

- Feed-through block for mounting on TS 35
- Nominal cross section 35 mm<sup>2</sup>



Description	Type	Part No.	Std. Pack
Feed-through block	gray	9700 A/16 S 35	54.035.7553.0
Feed-through block, (Ex)i	blue	9700 A/16 S 35 BLAU	54.035.7553.6

#### GENERAL DATA

Width / length / height, incl. TS 7.5	16 mm / 59 mm / 58 mm
Wire strip length	20 mm
Approvals	

#### TECHNICAL DATA

	IEC	UL	CSA
	EN 60 947-7-1		
Cross section fine-stranded	2,5 – 35 mm <sup>2</sup>		
Cross section solid/stranded	2,5 – 50 mm <sup>2</sup>		
Cross section, AWG		6–2	12–2
Rated current	125 A	115/130 A	125 A
Rated voltage	1000 V	600 V	600 V
Rated impulse voltage	8 kV		
Pollution degree	3		

#### ACCESSORIES

	Type	Part No.	Std. Pack
End plate	gray	9701/12	07.310.3353.0
Partition	gray	9702/12	07.310.3653.0
Cross connector with screws, E-Cu, uninsulated	2-pole	9703/16-2	Z7.216.0227.0
	3-pole	9703/16-3	Z7.216.0327.0
	4-pole	9703/16-4	Z7.216.0427.0
	5-pole	9703/16-5	Z7.216.0527.0
	6-pole	9703/16-6	Z7.216.0627.0
2-pole switchable jumper		Z7.269.3423.0	50
Adapter for test plug		05.508.6521.0	10
Cover with warn. symbol for 1 block	yellow	04.325.1456.0	10

# GROUND BLOCKS WITH SCREW CONNECTION, TYP 9700 A.. S35

## 9700 A/6 SL2 S35

- Ground block for mounting on TS 35
- Nominal cross section 4 mm<sup>2</sup>

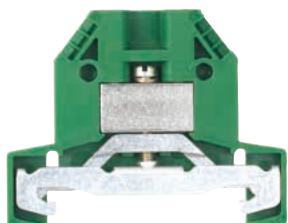

Description	Type	Part No.	Std. Pack
Ground block	green-yellow	9700 A/6 SL 2 S 35	56.004.9053.0 100
<b>GENERAL DATA</b>			
Width / length / height, incl. TS 7.5	6 mm / 48 mm / 38 mm		
Wire strip length	9 mm		
Approvals			
<b>TECHNICAL DATA</b>		<b>IEC</b>	<b>UL</b> <b>CSA</b>
	EN 60 947-7-2		
Cross section fine-stranded	0.5 – 4 mm <sup>2</sup>		
Cross section solid/stranded	0.5 – 6 mm <sup>2</sup>		
Cross section, AWG		18 – 10	22 – 10
Rated current			
Rated voltage	800 V	600 V	600 V
Rated impulse voltage	8 kV		
Pollution degree	3		
<b>ACCESSORIES</b>		<b>Type</b>	<b>Part No.</b> <b>Std. Pack</b>
End plate	green	9701/6 SL	07.312.0053.0 10

## 9700 A/8 SL2 S35

- Ground block for mounting on TS 35
- Nominal cross section 10 mm<sup>2</sup>

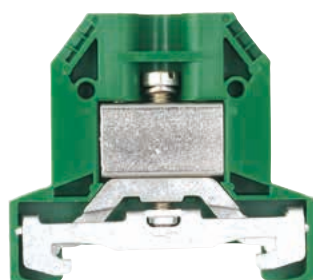

Description	Type	Part No.	Std. Pack
Ground block	green-yellow	9700 A/8 SL 2 S 35	56.010.9053.0 100
<b>GENERAL DATA</b>			
Width / length / height, incl. TS 7.5	8 mm / 53 mm / 48 mm		
Wire strip length	11 mm		
Approvals			
<b>TECHNICAL DATA</b>		<b>IEC</b>	<b>UL</b> <b>CSA</b>
	EN 60 947-7-2		
Cross section fine-stranded	0.5 – 10 mm <sup>2</sup>		
Cross section solid/stranded	0.5 – 10 mm <sup>2</sup>		
Cross section, AWG		18 – 8	18 – 8
Rated current			
Rated voltage	800 V	600 V	600 V
Rated impulse voltage	8 kV		
Pollution degree	3		
<b>ACCESSORIES</b>		<b>Type</b>	<b>Part No.</b> <b>Std. Pack</b>
End plate	green	9701/8 SL	07.312.0153.0 10

## 9700 A/10 SL2 S35

- Ground block for mounting on TS 35
- Nominal cross section 16 mm<sup>2</sup>



Description	Type	Part No.	Std. Pack
Ground block	green-yellow	9700 A/10 SL 2 S 35	56.016.9053.0 50
<b>GENERAL DATA</b>			
Width / length / height, incl. TS 7.5	10 mm / 53 mm / 51 mm		
Wire strip length	16 mm		
Approvals			
<b>TECHNICAL DATA</b>		<b>IEC</b>	<b>UL</b> <b>CSA</b>
	EN 60 947-7-2		
Cross section fine-stranded	1.5 – 16 mm <sup>2</sup>		
Cross section solid/stranded	1.5 – 16 mm <sup>2</sup>		
Cross section, AWG		18 – 6	16 – 6
Rated current			
Rated voltage	800 V	600 V	600 V
Rated impulse voltage	8 kV		
Pollution degree	3		
<b>ACCESSORIES</b>		<b>Type</b>	<b>Part No.</b> <b>Std. Pack</b>
End plate	green	9701/10 SL	07.312.0253.0 10

### 9700 A/16 SL2 S35

- Ground block for mounting on TS 35
- Nominal cross section 35 mm<sup>2</sup>



Description	Type	Part No.	Std. Pack
Ground block	green-yellow	9700 A/16 SL 2 S 35	56.035.9053.0 50

#### GENERAL DATA

Width / length / height, incl. TS 7.5	16 mm / 53 mm / 58 mm
Wire strip length	18 mm
Approvals	

#### TECHNICAL DATA

	IEC	UL	CSA
	EN 60 947-7-2		
Cross section fine-stranded	2.5 – 35 mm <sup>2</sup>		
Cross section solid/stranded	2.5 – 50 mm <sup>2</sup>		
Cross section, AWG		12–2	12–2
Rated current			
Rated voltage	800 V	600 V	600 V
Rated impulse voltage	8 kV		
Pollution degree	3		

#### ACCESSORIES

Description	Type	Part No.	Std. Pack
End plate	green	9701/16 SL	07.312.0353.0 10



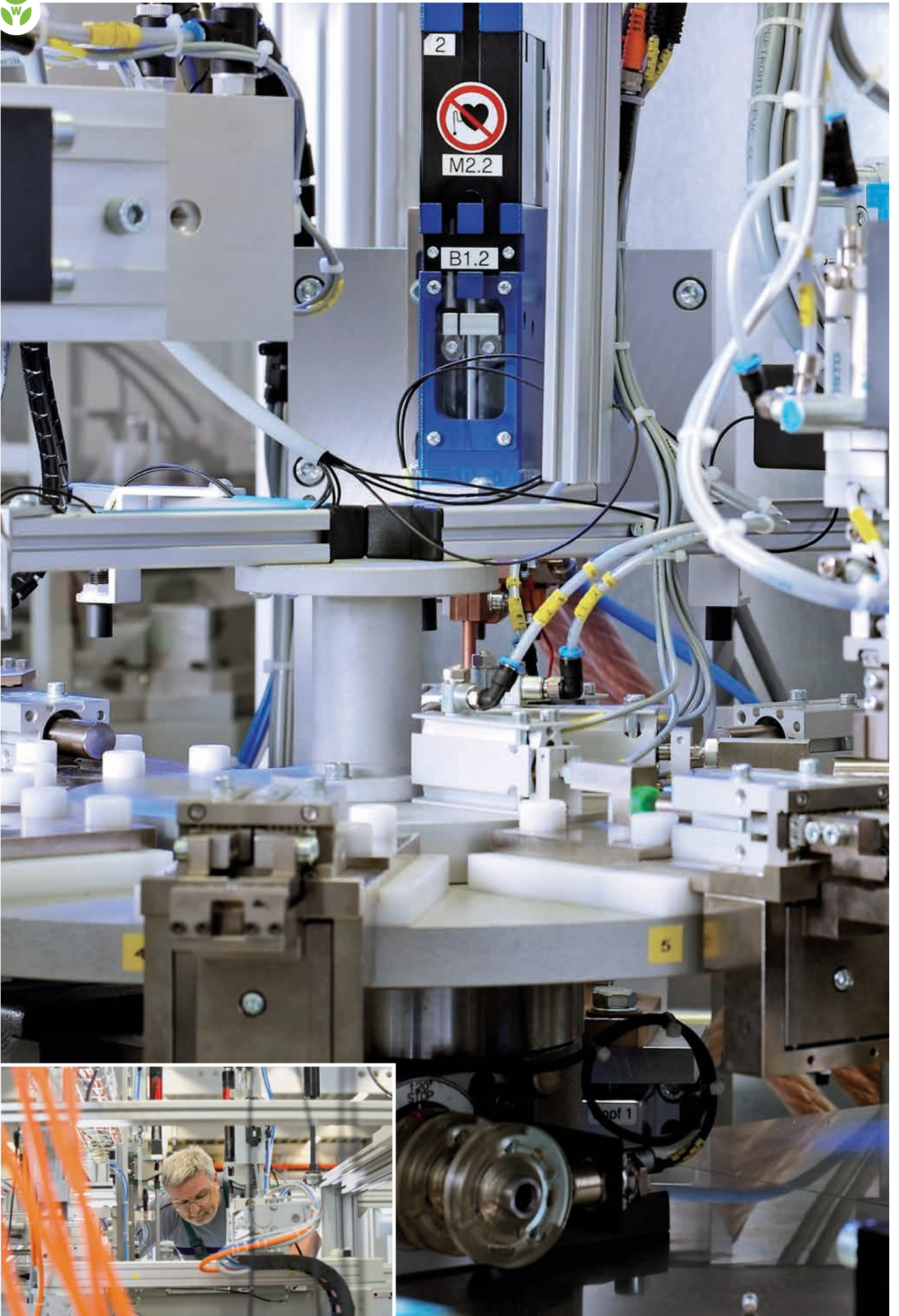

# FASIS WKFN

## DIN RAIL TERMINAL BLOCKS WITH TENSION SPRING CONNECTION

The DIN rail terminal block with tension spring technology: fasis WKFN is easy to operate, saves time and costs during wiring and reduces inventory costs, and guarantees vibration-proof and maintenance-free connections with high contact forces.

The product line includes feed-through and ground blocks with 2, 3 or 4 termination point as well as multi-tier blocks in two- and three-tier designs, knife-edge disconnect blocks in one- and two-tier designs and fuse blocks. In addition, specialty function blocks are available with application-specific diode circuits.

fasis WKFN has been designed for use in machinery and plant construction as well as hazardous locations subject to explosion.

Connection cross-sections up to 35 mm<sup>2</sup>

Rated current of up to 125 A

Rated voltage of up to 1000 V

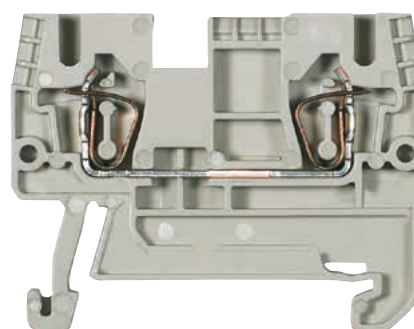
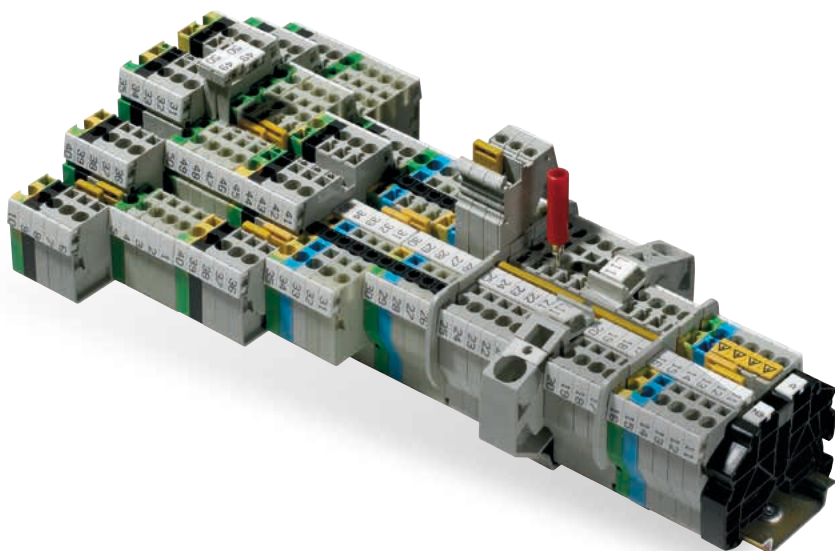





# DIN RAIL TERMINAL BLOCKS WITH TENSION SPRING CONNECTION

The DIN rail terminal block with tension spring technology: fasis WKFN is easy to operate, saves time and costs during wiring and reduces inventory costs, and guarantees vibration-proof and maintenance-free connections with high contact forces.

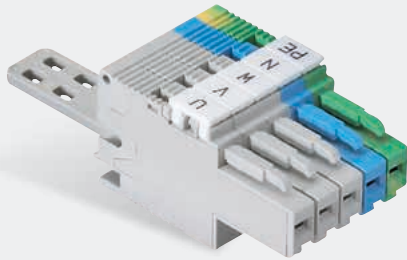

## PLUG & PLAY IN THE CONTROL CABINET

- Plug-in system – fasis CON
- 32 A und 4 mm<sup>2</sup> auf nur 5 mm Baubreite

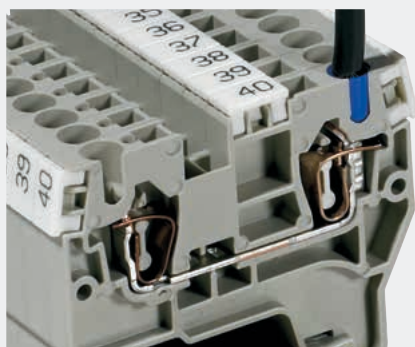
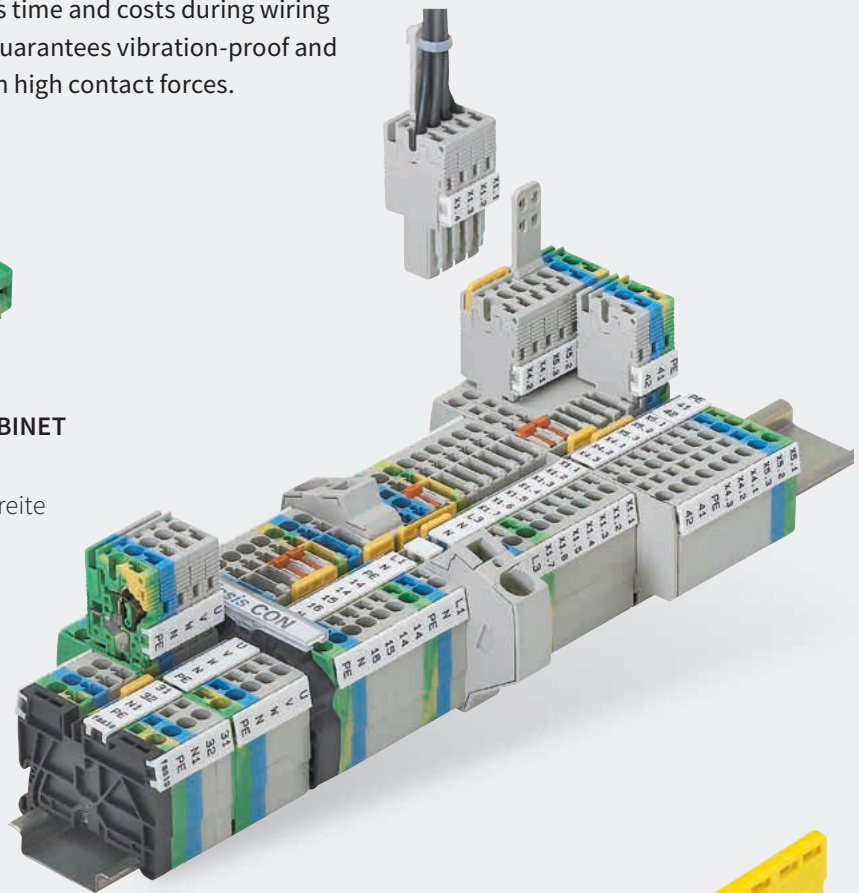

## DURABLE AND MAINTENANCE-FREE CONNECTION

- Tension spring connection resistant to vibration
- Connect with and without ferrules

## FINE-STRANDED WIRE PERFECTLY CONNECTED

- Simple operation with a standard screwdriver
- Screwdriver is held securely in the terminal for optimal handling while connecting wires

## COMPLETING THE CONCEPT

- Dual jumpering channels
- Plug-in jumper bars
- Potential distribution by supply block up to 76 A



## EASY TESTING

- Function check via modular test adapter
- Integrated test jacks in all blocks

# WIELAND JUMPERING SYSTEM – PERFECT TECHNOLOGY

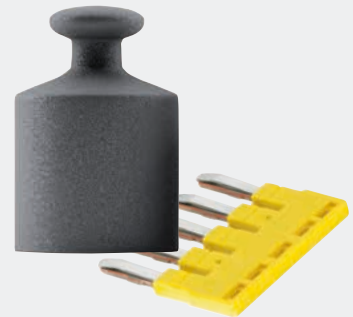
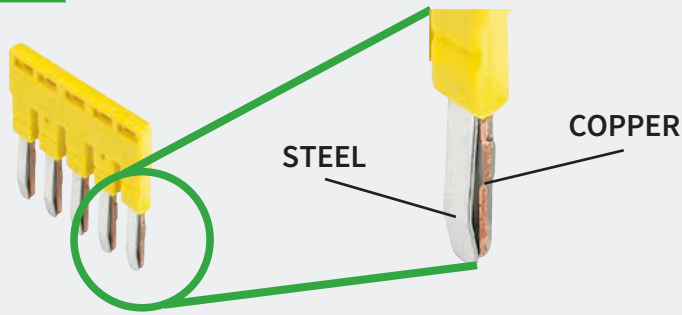

## PERFECT TECHNOLOGY

- Copper current bar guarantees low contact resistance
- Steel spring guarantees strength, durability, and long-term stability

## EXTREMELY RUGGED!

- Indestructible steel spring
- Vibration-proof connection

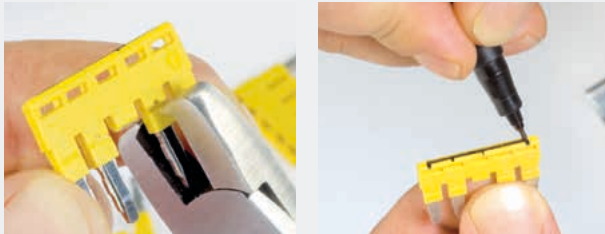

## SIMPLE CUSTOMIZATION

- Individual poles easy to remove
- Circuits easy to identify

# WIELAND MARKING SYSTEM – RELIABLE IDENTIFICATION



## MARKING STRIPS – DEPENDABLE

- Maximum hold to the terminal
- Solidify integrity of the assembly

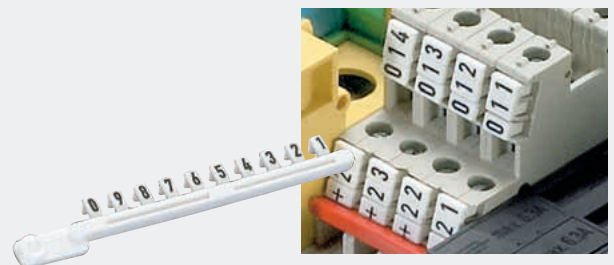

## MARKING TAGS – INDIVIDUAL

- Individual labeling with minimum effort
- Ideal for service and maintenance

## THE ACCESSORIES

- Wire entry guide strips for secure connection of wires smaller than 1 mm<sup>2</sup>
- Snap-on covers with warning symbols
- Wieland screwdriver for optimal operation of spring tension terminals





# FEED-THROUGH BLOCKS WITH TENSION SPRING CONNECTION

## WKF 1,5/35

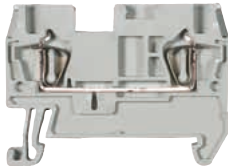
- Feed-through block with tension spring connection for mounting on TS 35
- Nominal cross section 1.5 mm<sup>2</sup>
- Ex e II  II 2GD  
Follow the EX installation instructions on page 174



Description	Type	Part No.	Std. Pack
Feed-through block	gray WKF 1,5/35	56.702.0053.0	50
Feed-through block	blue WKF 1,5/35 BLAU	56.702.0053.6	50



GENERAL DATA				
Width / length / height, incl. TS 7.5	4 mm / 49 mm / 37 mm			
Wire strip length	10 mm			
Approvals	ATEX  		KEMA 03 ATEX 2056 U	
TECHNICAL DATA				
	IEC	UL	CSA	
	EN 60 947-7-1			
Cross section fine-stranded	0.08 – 1.5 mm <sup>2</sup>		EN 60 079-0/-7	
Cross section solid/stranded	0.08 – 1.5 mm <sup>2</sup>		0.14 – 1.5 mm <sup>2</sup>	
Cross section, AWG	26 – 14		26 – 14	
Rated current	17.5 A	15 A	15 A	17.5/16.5 A <sup>3)</sup>
Rated voltage	500 V	300 V	300 V	440 V <sup>*)</sup>
Rated impulse voltage	6 kV			
Pollution degree	3			
ACCESSORIES				
	Type	Part No.	Std. Pack	
End plate	gray APF 1,5	07.312.8153.0	10	
Partition	gray TWF 1,5	07.312.8253.0	10	

## WKF 1,5 D1/2/35

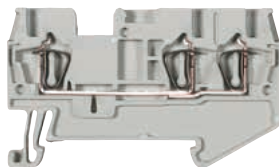
- Duo feed-through block with tension spring connection for mounting on TS 35
- Nominal cross section 1.5 mm<sup>2</sup>
- Ex e II  II 2GD  
Follow the EX installation instructions on page 174



Description	Type	Part No.	Std. Pack
Feed-through block	gray WKF 1,5 D1/2/35	56.702.5053.0	50
Feed-through block	blue WKF 1,5 D1/2/35 BLAU	56.702.5053.6	50



GENERAL DATA				
Width / length / height, incl. TS 7.5	4 mm / 60 mm / 37 mm			
Wire strip length	10 mm			
Approvals	ATEX  		KEMA 03 ATEX 2056 U	
TECHNICAL DATA				
	IEC	UL	CSA	
	EN 60 947-7-1			
Cross section fine-stranded	0.08 – 1.5 mm <sup>2</sup>		EN 60 079-0/-7	
Cross section solid/stranded	0.08 – 1.5 mm <sup>2</sup>		0.14 – 1.5 mm <sup>2</sup>	
Cross section, AWG	26 – 14		26 – 14	
Rated current	17.5 A	15 A	15 A	17.5/16.5 A <sup>3)</sup>
Rated voltage	500 V	300 V	300 V	440 V <sup>*)</sup>
Rated impulse voltage	6 kV			
Pollution degree	3			
ACCESSORIES				
	Type	Part No.	Std. Pack	
End plate	gray APF 1,5 D1/2	07.312.8353.0	10	
Segment end plate	gray SAPF 1,5	07.312.8953.0	10	
Partition	gray TWF 1,5 D1/2	07.312.8453.0	10	

## WKF 1,5 D2/2/35

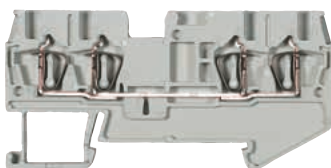
- Duo feed-through block with tension spring connection for mounting on TS 35
- Nominal cross section 1.5 mm<sup>2</sup>
- Ex e II  II 2GD  
Follow the EX installation instructions on page 174



Description	Type	Part No.	Std. Pack
Feed-through block	gray WKF 1,5 D2/2/35	56.702.5153.0	50
Feed-through block	blue WKF 1,5 D2/2/35 BLAU	56.702.5153.6	50

GENERAL DATA				
Width / length / height, incl. TS 7.5	4 mm / 72 mm / 37 mm			
Wire strip length	10 mm			
Approvals	ATEX  		KEMA 03 ATEX 2056 U	
TECHNICAL DATA				
	IEC	UL	CSA	
	EN 60 947-7-1			
Cross section fine-stranded	0.08 – 1.5 mm <sup>2</sup>		EN 60 079-0/-7	
Cross section solid/stranded	0.08 – 1.5 mm <sup>2</sup>		0.14 – 1.5 mm <sup>2</sup>	
Cross section, AWG	26 – 14		26 – 14	
Rated current	17.5 A	15 A	15 A	17.5/16.5 A <sup>3)</sup>
Rated voltage	500 V	300 V	300 V	440 V <sup>*)</sup>
Rated impulse voltage	6 kV			
Pollution degree	3			
ACCESSORIES				
	Type	Part No.	Std. Pack	
End plate	gray APF 1,5 D2/2	07.312.8553.0	10	
Segment end plate	gray SAPF 1,5	07.312.8953.0	10	
Partition	gray TWF 1,5 D2/2	07.312.8653.0	10	



## ACCESSORIES FOR FASIS WKF 1,5...



Accessories	Type	Part No.	Std. Pack	
Cross connector, insulated	2-pole	IVB WKF 1,5-2	Z7.268.0227.0	10
	3-pole	IVB WKF 1,5-3	Z7.268.0327.0	10
	4-pole	IVB WKF 1,5-4	Z7.268.0427.0	10
	5-pole	IVB WKF 1,5-5	Z7.268.0527.0	10
	10-pole	IVB WKF 1,5-10	Z7.268.1027.0	10
	20-pole	IVB WKF 1,5-20	Z7.268.2027.0	10
Wire entry guide	0.13-0.2 mm <sup>2</sup>	LEL 1,5/1 WEISS	05.564.4253.0	10
	0.25-0.5 mm <sup>2</sup>	LEL 1,5/2 GRAU	05.564.4353.0	10
Cover with warning symbol over 5 blocks	ADF 1,5/5 GELB	04.343.6953.8	10	
Screwdriver, uninsulated	DIN 5264 B 0,4x2,5	06.502.4300.0	5	

<sup>1)</sup> For maintaining the proper isolation distances, the open side of a feed-through terminal block as well as both sides of a jumper are to be covered by partitions.  
<sup>3)</sup> Rated current when using cross connectors



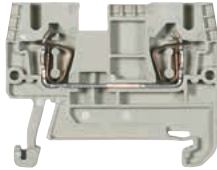

# FEED-THROUGH BLOCKS WITH TENSION SPRING CONNECTION

## WKFN 2,5/35

- Feed-through block with tension spring connection for mounting on TS 35
- Nominal cross section 2.5 mm<sup>2</sup>
- Ex e I/II  II 2GD IM2  
Follow the EX installation instructions on page 174



Description	Type	Part No.	Std. Pack
Feed-through block	gray WKFN 2,5/35	56.703.0055.0	100
Feed-through block	blue WKFN 2,5/35 BLAU	56.703.0055.6	100

GENERAL DATA				
Width / length / height, incl. TS 7.5	5 mm / 47 mm / 38 mm			
Wire strip length	11 mm			
Approvals	PTB    			PTB 04 ATEX 1051 U
TECHNICAL DATA				
	IEC	UL	CSA	
	EN 60 947-1-1			
Cross section fine-stranded	0.13 – 2.5 mm <sup>2</sup>			EN 60 079-0/-7
Cross section solid/stranded	0.13 – 4 mm <sup>2</sup>			0.2 – 2.5 mm <sup>2</sup>
Cross section, AWG	22 – 12		24 – 12	0.13 – 4 mm <sup>2</sup>
Rated current	24 A	20 A	24 A	22 A <sup>1)</sup>
Rated voltage	800 V	600 V	600 V	550 V
Rated impulse voltage	8 kV			
Pollution degree	3			
<b>Note</b>	<sup>1)</sup> for 40 K and 45 K			



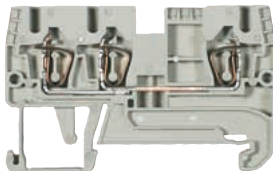

ACCESSORIES	Type	Part No.	Std. Pack
End plate	gray APFN 2,5	07.312.6755.0	10
End plate	blue APFN 2,5 BLAU	07.312.6755.6	10
Partition	gray TWFN 2,5	07.312.6855.0	10

## WKFN 2,5 D1/2/35

- Duo feed-through block with tension spring connection for mounting on TS 35
- Nominal cross section 2.5 mm<sup>2</sup>
- Ex e I/II  II 2GD IM2  
Follow the EX installation instructions on page 174



Description	Type	Part No.	Std. Pack
Feed-through block	gray WKFN 2,5 D1/2/35	56.703.5055.0	100
Feed-through block	blue WKFN 2,5 D1/2/35 BLAU	56.703.5055.6	100

GENERAL DATA				
Width / length / height, incl. TS 7.5	5 mm / 60 mm / 38 mm			
Wire strip length	11 mm			
Approvals	PTB    			PTB 04 ATEX 1051 U
TECHNICAL DATA				
	IEC	UL	CSA	
	EN 60 947-1-1			
Cross section fine-stranded	0.13 – 2.5 mm <sup>2</sup>			EN 60 079-0/-7
Cross section solid/stranded	0.13 – 4 mm <sup>2</sup>			0.2 – 2.5 mm <sup>2</sup>
Cross section, AWG	22 – 12		24 – 12	0.13 – 4 mm <sup>2</sup>
Rated current	24 A	20 A	24 A	22 A <sup>1)</sup>
Rated voltage	800 V	600 V	600 V	550 V
Rated impulse voltage	8 kV			
Pollution degree	3			
<b>Note</b>	<sup>1)</sup> for 40 K and 45 K			



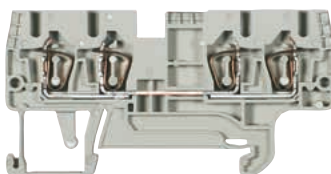

ACCESSORIES	Type	Part No.	Std. Pack
End plate	gray APFN 2,5 D1/2	07.312.6955.0	10
End plate	blue APFN 2,5 D1/2 BLAU	07.312.6955.6	10
Partition	gray TWFN 2,5 D1/2	07.312.7055.0	10

## WKFN 2,5 D2/2/35

- Duo feed-through block with tension spring connection for mounting on TS 35
- Nominal cross section 2.5 mm<sup>2</sup>
- Ex e I/II  II 2GD IM2  
Follow the EX installation instructions on page 174



Description	Type	Part No.	Std. Pack
Feed-through block	gray WKFN 2,5 D2/2/35	56.703.5155.0	100
Feed-through block	blue WKFN 2,5 D2/2/35 BLAU	56.703.5155.6	100

GENERAL DATA				
Width / length / height, incl. TS 7.5	5 mm / 72 mm / 38 mm			
Wire strip length	11 mm			
Approvals	PTB    			PTB 04 ATEX 1051 U
TECHNICAL DATA				
	IEC	UL	CSA	
	EN 60 947-1-1			
Cross section fine-stranded	0.13 – 2.5 mm <sup>2</sup>			EN 60 079-0/-7
Cross section solid/stranded	0.13 – 4 mm <sup>2</sup>			0.2 – 2.5 mm <sup>2</sup>
Cross section, AWG	22 – 12		24 – 12	0.13 – 4 mm <sup>2</sup>
Rated current	24 A	20 A	24 A	22 A <sup>1)</sup>
Rated voltage	800 V	600 V	600 V	550 V
Rated impulse voltage	8 kV			
Pollution degree	3			
<b>Note</b>	<sup>1)</sup> for 40 K and 45 K			

ACCESSORIES	Type	Part No.	Std. Pack
End plate	gray APFN 2,5 D2/2	07.312.7155.0	10
End plate	blue APFN 2,5 D2/2 BLAU	07.312.7155.6	10
Partition	gray TWFN 2,5 D2/2	07.312.7255.0	10

# SUPPLY BLOCK



## WKF 16/35 PV/WKFN

- Supply block for mounting on TS 35
- Nominal cross section 16 mm<sup>2</sup>
- Ex e I/II II 2GD IM2  
Follow the EX installation instructions on page 174

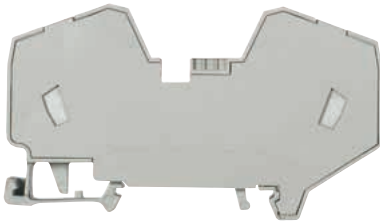

Description	Type	Part No.	Std. Pack	
Power feed-in block	gray	WKF 16/35 PV/WKFN	56.716.0353.0	20

GENERAL DATA				
Width / length / height, incl. TS 7.5	12 mm / 82 mm / 48 mm			
Wire strip length	15 mm			
Approvals			KEMA 01 ATEX 2087 U	

TECHNICAL DATA	IEC	UL	CSA	
	EN 60 947-7-1			EN 60 079-0/-7
Cross section fine-stranded	4 – 16 mm <sup>2</sup>			4 – 16 mm <sup>2</sup>
Cross section solid/stranded	4 – 16 mm <sup>2</sup>			4 – 16 mm <sup>2</sup>
Cross section, AWG		24 – 4	12 – 4	
Rated current	76 A	75 A	78 A	64 A <sup>*)</sup>
Rated voltage	800 V	600 V	600 V	690 V
Rated impulse voltage	8 kV			
Pollution degree	3			

**Note** \* Type-specific output currents upon request

ACCESSORIES	Type	Part No.	Std. Pack
Cover with warning symbol over 4 blocks	ADF 16/4 GELB	04.343.6653.8	10
Screwdriver, uninsulated	DIN 5264 B 1,0x5,5	06.502.4200.0	5

- Potential distribution with standard cross connector IVB WKF 2.5...
- Parallel connection of two cross connectors -> double jumpering
- Potential distributions are possible on one or both sides

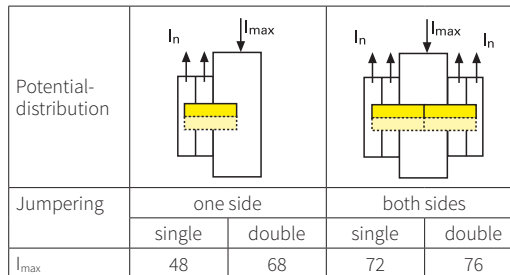

$$I_{\max} = \sum I_n \leq \sum I_{N \text{ block}}$$

## ACCESSORIES FOR FASIS WKFN 2,5...



ACCESSORIES	Type	Part No.	Std. Pack	
Cross connector, insulated	2-pole	IVB WKF 2,5 – 2	Z7.280.6227.0	10
	3-pole	IVB WKF 2,5 – 3	Z7.280.6327.0	10
	4-pole	IVB WKF 2,5 – 4	Z7.280.6427.0	10
	5-pole	IVB WKF 2,5 – 5	Z7.280.6527.0	10
	6-pole	IVB WKF 2,5 – 6	Z7.280.6627.0	10
	7-pole	IVB WKF 2,5 – 7	Z7.280.6727.0	20
	8-pole	IVB WKF 2,5 – 8	Z7.280.6827.0	20
	9-pole	IVB WKF 2,5 – 9	Z7.280.6927.0	20
	10-pole	IVB WKF 2,5 – 10	Z7.280.7027.0	20
	20-pole	IVB WKF 2,5 – 20	Z7.280.8027.0	20
Wire entry guide	0.13 – 0.2 mm <sup>2</sup>	LELN 2,5/1 WEISS	05.564.3755.0	100
	0.25 – 0.5 mm <sup>2</sup>	LELN 2,5/2 GRAU	05.564.3855.0	100
	0.75 – 1.0 mm <sup>2</sup>	LELN 2,5/3 SCHWARZ	05.564.3955.0	100
Cover with warning symbol over 4 blocks	yellow	ADF 16/4 GELB	04.343.6653.8	10
Test adapter, modular		PS WKC/F	Z1.299.9753.0	10
Test plug		ST 2/2,3	Z5.553.2921.0	10
Screwdriver, uninsulated		DIN 5264 B 0,6x3,5	06.502.4000.0	5
Screwdriver, uninsulated, MINI		DIN 5264 B 0,6x3,5 M	06.502.5000.0	10





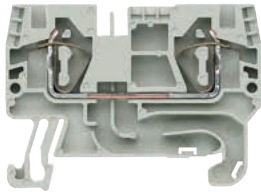

# FEED-THROUGH BLOCKS WITH TENSION SPRING CONNECTION

## WKFN 4/35

- Feed-through block with tension spring connection for mounting on TS 35
- Nominal cross section 4 mm<sup>2</sup>
- Ex e I/II  II 2GD IM2  
Follow the EX installation instructions on page 174



Description	Type	Part No.	Std. Pack
Feed-through block	gray	WKFN 4/35	56.704.0055.0 100
Feed-through block	blue	WKFN 4/35 BLAU	56.704.0055.6 100

GENERAL DATA				
Width / length / height, incl. TS 7.5	6 mm / 51 mm / 38 mm			
Wire strip length	11 mm			
Approvals	PTB     			PTB 05 ATEX 1104 U
TECHNICAL DATA				
	IEC	UL	CSA	
	EN 60 947-7-1			
Cross section fine-stranded	0.13 – 4 mm <sup>2</sup>			
Cross section solid/stranded	0.13 – 6 mm <sup>2</sup>			
Cross section, AWG		24 – 10	24 – 10	
Rated current	32 A	30 A	32 A	28/30 A <sup>1)</sup>
Rated voltage	800 V	600 V	600 V	690 V
Rated impulse voltage	8 kV			
Pollution degree	3			
<b>Note</b>	1) 1. value at 40 K/ 2. value at 45 K			





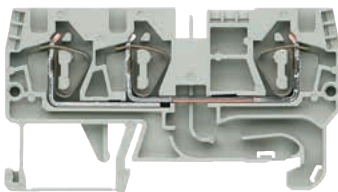

ACCESSORIES	Type	Part No.	Std. Pack
End plate	gray	APFN 4	07.312.9255.0 10
End plate	blue	APFN 4 BLAU	07.312.9255.6 10
Partition	gray	TWFN 4	07.312.9355.0 10

## WKFN 4 D1/2/35

- Duo feed-through block with tension spring connection for mounting on TS 35
- Nominal cross section 4 mm<sup>2</sup>
- Ex e I/II  II 2GD IM2  
Follow the EX installation instructions on page 174



Description	Type	Part No.	Std. Pack
Feed-through block	gray	WKFN 4 D1/2/35	56.704.5055.0 100
Feed-through block	blue	WKFN 4 D1/2/35 BLAU	56.704.5055.6 100

GENERAL DATA				
Width / length / height, incl. TS 7.5	6 mm / 67 mm / 38 mm			
Wire strip length	11 mm			
Approvals	PTB     			PTB 05 ATEX 1104 U
TECHNICAL DATA				
	IEC	UL	CSA	
	EN 60 947-7-1			
Cross section fine-stranded	0.13 – 4 mm <sup>2</sup>			
Cross section solid/stranded	0.13 – 6 mm <sup>2</sup>			
Cross section, AWG		24 – 10	24 – 10	
Rated current	32 A	30 A	32 A	28/30 A <sup>1)</sup>
Rated voltage	800 V	600 V	600 V	550 V
Rated impulse voltage	8 kV			
Pollution degree	3			
<b>Note</b>	1) 1. value at 40 K/ 2. value at 45 K			





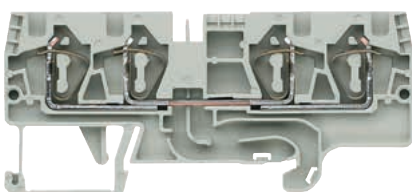

ACCESSORIES	Type	Part No.	Std. Pack
End plate	gray	APFN 4 D1/2	07.312.9455.0 10
End plate	blue	APFN 4 D1/2 BLAU	07.312.9455.6 10
Partition	gray	TWFN 4 D1/2	07.312.9555.0 10

## WKFN 4 D2/2/35

- Duo feed-through block with tension spring connection for mounting on TS 35
- Nominal cross section 4 mm<sup>2</sup>
- Ex e I/II  II 2GD IM2  
Follow the EX installation instructions on page 174



Description	Type	Part No.	Std. Pack
Feed-through block	gray	WKFN 4 D2/2/35	56.704.5155.0 100
Feed-through block	blue	WKFN 4 D2/2/35 BLAU	56.704.5155.6 100

GENERAL DATA				
Width / length / height, incl. TS 7.5	6 mm / 82 mm / 38 mm			
Wire strip length	11 mm			
Approvals	PTB     			PTB 05 ATEX 1104 U
TECHNICAL DATA				
	IEC	UL	CSA	
	EN 60 947-7-1			
Cross section fine-stranded	0.13 – 4 mm <sup>2</sup>			
Cross section solid/stranded	0.13 – 6 mm <sup>2</sup>			
Cross section, AWG		24 – 10	24 – 10	
Rated current	32 A	30 A	32 A	28/30 A <sup>1)</sup>
Rated voltage	800 V	600 V	600 V	550 V
Rated impulse voltage	8 kV			
Pollution degree	3			
<b>Note</b>	1) 1. value at 40 K/ 2. value at 45 K			

ACCESSORIES	Type	Part No.	Std. Pack
End plate	gray	APFN 4 D2/2	07.312.9055.0 10
End plate	blue	APFN 4 D2/2 BLAU	07.312.9055.6 10
Partition	gray	TWFN 4 D2/2	07.312.9155.0 10

## WKF 16/35 PV/WKFN

- Supply block for mounting on TS 35
- Nominal cross section 16 mm<sup>2</sup>
- Ex e I/II II 2GD IM2  
Follow the EX installation instructions on page 174

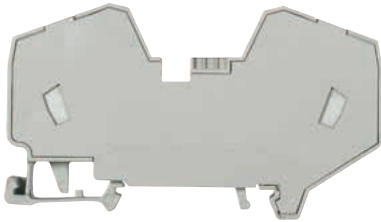

Description	Type	Part No.	Std. Pack	
Power feed-in block	gray	WKF 16/35 PV/WKFN	56.716.0353.0	20

### GENERAL DATA

Width / length / height, incl. TS 7.5	12 mm / 82 mm / 48 mm		
Wire strip length	15 mm		
Approvals		KEMA 01 ATEX 2087 U	

TECHNICAL DATA	IEC	UL	CSA	
	EN 60 947-7-1			EN 60 079-0/-7
Cross section fine-stranded	4 – 16 mm <sup>2</sup>			4 – 16 mm <sup>2</sup>
Cross section solid/stranded	4 – 16 mm <sup>2</sup>			4 – 16 mm <sup>2</sup>
Cross section, AWG		24 – 4	12 – 4	
Rated current	76 A	75 A	78 A	64 A*
Rated voltage	800 V	600 V	600 V	690 V
Rated impulse voltage	8 kV			
Pollution degree	3			

**Note** \* Type-specific output currents upon request

ACCESSORIES	Type	Part No.	Std. Pack
Cover with warning symbol over 4 blocks	ADF 16/4 GELB	04.343.6653.8	10
Screwdriver, uninsulated	DIN 5264 B 1,0x5,5	06.502.4200.0	5

- Potential distribution with standard cross connector IVB WKF 4...
- Parallel connection of two cross connectors -> double jumpering
- Potential distributions are possible on one or both sides

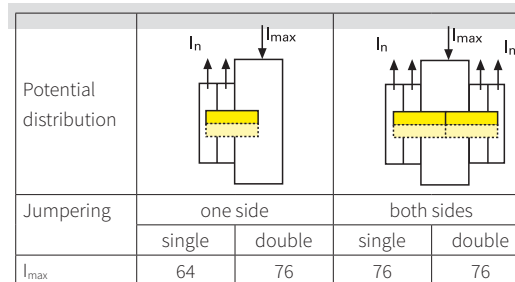

$$I_{max} = \sum I_n \leq \sum I_{N \text{ block}}$$

## ACCESSORIES FOR FASIS WKFN 4...

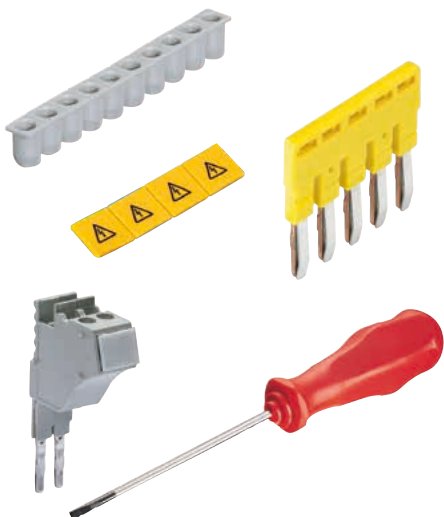

ACCESSORIES	Type	Part No.	Std. Pack	
Cross connector, insulated	2-pole	VB WKF 4-2	Z7.261.1227.0	10
	3-pole	IVB WKF 4-3	Z7.261.1327.0	10
	4-pole	IVB WKF 4-4	Z7.261.1427.0	10
	5-pole	IVB WKF 4-5	Z7.261.1527.0	10
	6-pole	IVB WKF 4-6	Z7.261.1627.0	10
	7-pole	IVB WKF 4-7	Z7.261.1727.0	20
	8-pole	IVB WKF 4-8	Z7.261.1827.0	20
	9-pole	IVB WKF 4-9	Z7.261.1927.0	20
	10-pole	IVB WKF 4-10	Z7.261.2027.0	20
	Wire entry guide	0.13 – 0.2 mm <sup>2</sup>	LEL 4/1 WEISS	05.561.8553.0
0.25 – 0.5 mm <sup>2</sup>		LEL 4/2 GRAU	05.561.8653.0	100
0.75 – 1.0 mm <sup>2</sup>		LEL 4/3 SCHWARZ	05.561.8753.0	100
Cover with warning symbol over 4 blocks	yellow	ADF 4/4 GELB	04.343.6153.8	10
Test adapter, modular		PS WKCF	Z1.299.9753.0	10
Test plug		ST 2/2,3	Z5.553.2921.0	10
Screwdriver, uninsulated		DIN 5264 B 0,6x3,5	06.502.4000.0	5
Screwdriver, uninsulated, MINI		DIN 5264 B 0,6x3,5 M	06.502.5000.0	10





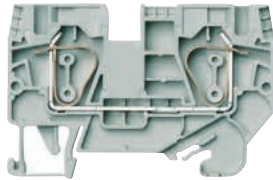

# FEED-THROUGH BLOCKS WITH TENSION SPRING CONNECTION

## WKFN 6/35

- Feed-through block with tension spring connection for mounting on TS 35
- Nominal cross section 6 mm<sup>2</sup>
- Ex e I/II  II 2GD IM2  
Follow the EX installation instructions on page 174



Description	Type	Part No.	Std. Pack	
Feed-through block	gray	WKFN 6/35	56.706.0055.0	100
Feed-through block	blue	WKFN 6/35 BLAU	56.706.0055.6	100

GENERAL DATA					
Width / length / height, incl. TS 7.5	8 mm / 66 mm / 45 mm				
Wire strip length	12 mm				
Approvals	PTB    			PTB 06 ATEX 1075 U	
TECHNICAL DATA		IEC	UL	CSA	
		EN 60 947-7-1			EN 60 079-0/-7
Cross section fine-stranded	0.2 – 6 mm <sup>2</sup>			0.2 – 6 mm <sup>2</sup>	
Cross section solid/stranded	1.5 – 10 mm <sup>2</sup>			1.5 – 10 mm <sup>2</sup>	
Cross section, AWG			24 – 8	24 – 8	
Rated current	41 A	50 A	41 A	39/41 A*	
Rated voltage	800 V	600 V	600 V	550 V	
Rated impulse voltage	8 kV				
Pollution degree	3				
<b>Note</b>					* 1. value at 40 K/ 2. value at 45 K



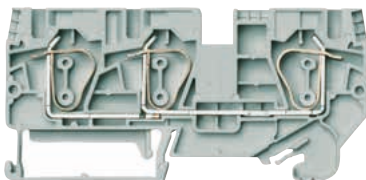

ACCESSORIES	Type	Part No.	Std. Pack	
End plate	gray	APFN 6	07.313.0455.0	10
End plate	blue	APFN 6 BLAU	07.313.0455.6	10
Partition	gray	TWFN 6	07.313.0555.0	10

## WKFN 6 D1/2/35

- Duo-feed-through block with tension spring connection for mounting on TS 35
- Nominal cross section 6 mm<sup>2</sup>
- Ex e I/II  II 2GD IM2  
Follow the EX installation instructions on page 174



Description	Type	Part No.	Std. Pack	
Feed-through block	gray	WKFN 6 D1/2/35	56.706.5055.0	100
Feed-through block	blue	WKFN 6 D1/2/35 BLAU	56.706.5055.6	100

GENERAL DATA					
Width / length / height, incl. TS 7.5	8 mm / 90 mm / 45 mm				
Wire strip length	12 mm				
Approvals	PTB    			PTB 06 ATEX 1075 U	
TECHNICAL DATA		IEC	UL	CSA	
		EN 60 947-7-1			EN 60 079-0/-7
Cross section fine-stranded	0.2 – 6 mm <sup>2</sup>			0.2 – 6 mm <sup>2</sup>	
Cross section solid/stranded	1.5 – 10 mm <sup>2</sup>			1.5 – 10 mm <sup>2</sup>	
Cross section, AWG			24 – 8	24 – 8	
Rated current	41 A	50 A	41 A	39/41 A*	
Rated voltage	800 V	600 V	600 V	550 V	
Rated impulse voltage	8 kV				
Pollution degree	3				
<b>Note</b>					* 1. value at 40 K/ 2. value at 45 K

ACCESSORIES	Type	Part No.	Std. Pack	
End plate	gray	APFN 6 D1/2	07.313.0655.0	10
End plate	blue	APFN 6 D1/2 BLAU	07.313.0655.6	10
Partition	gray	TWFN 6 D1/2	07.313.0755.0	10

## ACCESSORIES FOR FASIS WKFN 6...

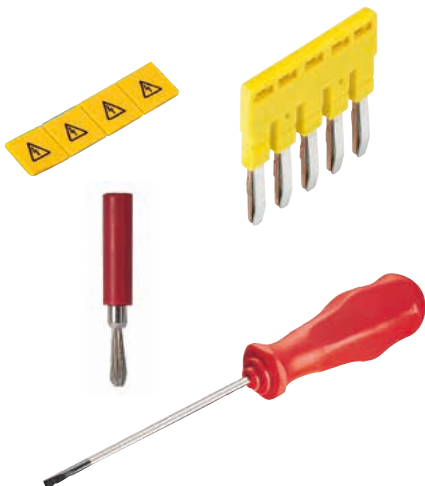

ACCESSORIES	Type	Part No.	Std. Pack	
Cross connector, insulated**	2-pole	IVB WKFN 6 – 2	Z7.282.5227.0	10
	3-pole	IVB WKFN 6 – 3	Z7.282.5327.0	10
	4-pole	IVB WKFN 6 – 4	Z7.282.5427.0	10
	5-pole	IVB WKFN 6 – 5	Z7.282.5527.0	10
	Cover with warning symbol over 4 blocks	yellow	ADF 6/4 GELB	04.343.6253.8
Test plug		ST 2/2,3	Z5.553.2921.0	10
Screwdriver, uninsulated		DIN 5264 B 0,8x4	06.502.4100.0	5

\*\* When cross connectors are used according to EN 60079-0 and EN 60079-7, the current must be reduced to max. 3.5 A.

## WKFN 10/35

- Feed-through block with tension spring connection for mounting on TS 35
  - Nominal cross section 10 mm<sup>2</sup>
  - Ex e I/II II 2GD IM2  
Follow the EX installation instructions on page 174
- <sup>3)</sup> Pls. note that the current must be reduced for EX applications.

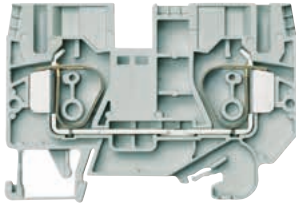

Description	Type	Part No.	Std. Pack
Feed-through block	gray WKFN 10/35	56.710.0055.0	50
Feed-through block	blue WKFN 10/35 BLAU	56.710.0055.6	50

GENERAL DATA					
Width / length / height, incl. TS 7.5	10 mm / 72 mm / 50 mm				
Wire strip length	15 mm				
Approvals	PTB			PTB 06 ATEX 1075 U	
TECHNICAL DATA		IEC	UL	CSA	
		EN 60 947-7-1			
Cross section fine-stranded	0.2 – 10 mm <sup>2</sup>			EN 60 079-0/-7	
Cross section solid/stranded	1.5 – 16 mm <sup>2</sup>			0.2 – 10 mm <sup>2</sup>	
Cross section, AWG	16 – 6			16 – 6	
Rated current	57 A	60 A	65 A	52/57 A*	
Rated voltage	800 V	600 V	600 V	550 V	
Rated impulse voltage	8 kV				
Pollution degree	3				
<b>Note</b>					* 1. value at 40 K/ 2. value at 45 K

ACCESSORIES	Type	Part No.	Std. Pack
End plate	gray APFN 10	07.313.0855.0	10
End plate	blue APFN 10 BLAU	07.313.0855.6	10
Partition	gray TWFN 10	07.313.0955.0	10

## WKFN 10 D1/2/35

- Duo-feed-through block with tension spring connection for mounting on TS 35
  - Nominal cross section 10 mm<sup>2</sup>
  - Ex e I/II II 2GD IM2  
Follow the EX installation instructions on page 174
- <sup>3)</sup> Pls. note that the current must be reduced for EX applications.

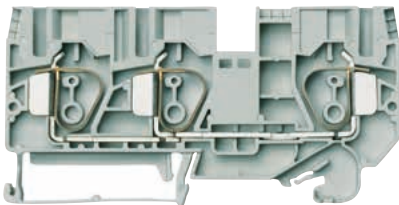

Description	Type	Part No.	Std. Pack
Feed-through block	gray WKFN 10 D1/2/35	56.710.5055.0	50
Feed-through block	blue WKFN 10 D1/2/35 BLAU	56.710.5055.6	50

GENERAL DATA					
Width / length / height, incl. TS 7.5	10 mm / 98 mm / 50 mm				
Wire strip length	15 mm				
Approvals	PTB			PTB 06 ATEX 1075 U	
TECHNICAL DATA		IEC	UL	CSA	
		EN 60 947-7-1			
Cross section fine-stranded	0.2 – 10 mm <sup>2</sup>			EN 60 079-0/-7	
Cross section solid/stranded	1.5 – 16 mm <sup>2</sup>			0.2 – 10 mm <sup>2</sup>	
Cross section, AWG	16 – 6			16 – 6	
Rated current	57 A	60 A	65 A	52/57 A*	
Rated voltage	1000 V	600 V	600 V	550 V	
Rated impulse voltage	8 kV				
Pollution degree	3				
<b>Note</b>					* 1. value at 40 K/ 2. value at 45 K

ACCESSORIES	Type	Part No.	Std. Pack
End plate	gray APFN 10 D1/2	07.313.1055.0	10
End plate	blue APFN 10 D1/2 BLAU	07.313.1055.6	10
Partition	gray TWFN 10 D1/2	07.313.1155.0	10

## ACCESSORIES FOR FASIS WKFN 10...



ACCESSORIES	Type	Part No.	Std. Pack
Cross connector, insulated**	2-pole IVB WKF 10 – 2	Z7.283.8227.0	10
Reducing jumper, WKF 35 to WKFN 10 <sup>3)</sup>	IVB WKFN 35R10	Z7.285.6427.0	10
Cover with warning symbol over 4 blocks	yellow ADF 10/4 GELB	04.343.6453.8	10
Test plug	ST 2/2,3	Z5.553.2921.0	10
Screwdriver, uninsulated	DIN 5264 B 1x5,5	06.502.4200.0	5

\*\* When cross connectors are used acc. to EN 60079-0 and EN 60079-7 the current must be reduced to 4 A/40 K or 5 A/45 K for type WKFN 10/35.



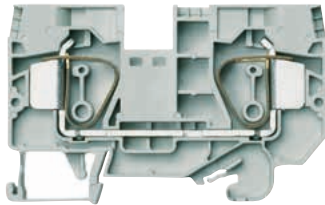

# FEED-THROUGH BLOCKS WITH TENSION SPRING CONNECTION

## WKFN 16/35

- Feed-through block with tension spring connection for mounting on TS 35
- Nominal cross section 16 mm<sup>2</sup>
- Ex e I/II  II 2GD IM2  
Follow the EX installation instructions on page 174



Description	Type	Part No.	Std. Pack
Feed-through block	gray	WKFN 16/35	56.716.0055.0 50
Feed-through block	blue	WKFN 16/35 BLAU	56.716.0055.6 100

GENERAL DATA					
Width / length / height, incl. TS 7.5	12 mm / 79 mm / 50 mm				
Wire strip length	16 mm				
Approvals	PTB    			PTB 06 ATEX 1075 U	
TECHNICAL DATA		IEC	UL	CSA	
		EN 60 947-7-1			
Cross section fine-stranded	0.2 – 16 mm <sup>2</sup>				EN 60 079-0/-7
Cross section solid/stranded	1.5 – 25 mm <sup>2</sup>				0.2 – 16 mm <sup>2</sup>
Cross section, AWG			16 – 4	16 – 4	1.5 – 25 mm <sup>2</sup>
Rated current	76 A	85 A	85 A	74/76 A*	
Rated voltage	1000 V	600 V	600 V	550 V	
Rated impulse voltage	8 kV				
Pollution degree	3				
<b>Note</b>					* 1. value at 40 K/ 2. value at 45 K



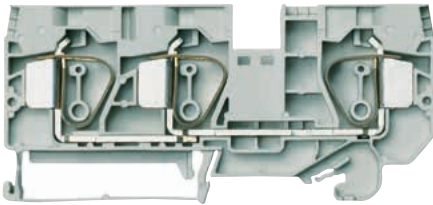

ACCESSORIES	Type	Part No.	Std. Pack
End plate	gray	APFN 16	07.313.1255.0 10
End plate	blue	APFN 16 BLAU	07.313.1255.6 10
Partition	gray	TWFN 16	07.313.1355.0 10
Cross connector, insulated**	2-pole	IVB WKF 16 – 2	Z7.284.4227.0 10
Cover with warning symbol for 4 blocks		ADF 16/4 GELB	04.343.6653.8 10

## WKFN 16 D1/2/35

- Duo-feed-through block with tension spring connection for mounting on TS 35
- Nominal cross section 16 mm<sup>2</sup>
- Ex e I/II  II 2GD IM2  
Follow the EX installation instructions on page 174



Description	Type	Part No.	Std. Pack
Feed-through block	gray	WKFN 16 D1/2/35	56.716.5055.0 50
Feed-through block	blue	WKFN 16 D1/2/35 BLAU	56.716.5055.6 100

GENERAL DATA					
Width / length / height, incl. TS 7.5	12 mm / 107 mm / 50 mm				
Wire strip length	16 mm				
Approvals	PTB    			PTB 06 ATEX 1075 U	
TECHNICAL DATA		IEC	UL	CSA	
		EN 60 947-7-1			
Cross section fine-stranded	0.2 – 16 mm <sup>2</sup>				EN 60 079-0/-7
Cross section solid/stranded	1.5 – 25 mm <sup>2</sup>				0.2 – 16 mm <sup>2</sup>
Cross section, AWG			16 – 4	16 – 4	1.5 – 25 mm <sup>2</sup>
Rated current	76 A	85 A	85 A	74/76 A*	
Rated voltage	1000 V	600 V	600 V	550 V	
Rated impulse voltage	8 kV				
Pollution degree	3				
<b>Note</b>					* 1. value at 40 K/ 2. value at 45 K



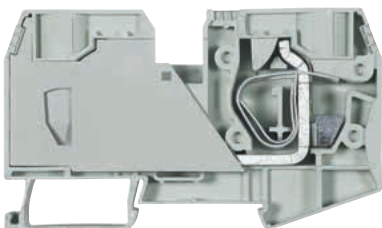

ACCESSORIES	Type	Part No.	Std. Pack
End plate	gray	APFN 16 D1/2	07.313.1455.0 10
End plate	blue	APFN 16 D1/2 BLAU	07.313.1455.6 10
Partition	gray	TWFN 16 D1/2	07.313.1555.0 10
Cross connector, insulated**	2-pole	IVB WKF 16 – 2	Z7.284.4227.0 10
Cover with warning symbol for 4 blocks		ADF 16/4 GELB	04.343.6653.8 10

## WKF 35/35

- Feed-through block with tension spring connection for mounting on TS 35
- Nominal cross section 35 mm<sup>2</sup>
- Ex e II  II 2GD  
Follow the EX installation instructions on page 174



Description	Type	Part No.	Std. Pack
Feed-through block	gray	WKF 35/35	56.735.0053.0 10
Feed-through block	blue	WKF 35/35 BLAU	56.735.0053.6 10

GENERAL DATA					
Width / length / height, incl. TS 7.5	16 mm / 100 mm / 59 mm				
Wire strip length	25 mm				
Approvals	ATEX    			KEMA 03 ATEX 2057 U	
TECHNICAL DATA		IEC	UL	CSA	
		EN 60 947-7-1			
Cross section fine-stranded	2.5 – 35 mm <sup>2</sup>				EN 60 079-0/-7
Cross section solid/stranded	2.5 – 35 mm <sup>2</sup>				2.5 – 35 mm <sup>2</sup>
Cross section, AWG			12 – 2	12 – 2	2.5 – 35 mm <sup>2</sup>
Rated current	125 A	115 A	115 A	92/108 A <sup>1)</sup>	
Rated voltage	800 V	600 V	600 V	690 V	
Rated impulse voltage	8 kV				
Pollution degree	3				
<b>Note</b>					<sup>1)</sup> with/without jumper

ACCESSORIES	Type	Part No.	Std. Pack
Cross connector, insulated	2-pole	IVB WKF 35-2	Z7.285.6227.0 10

# POTENTIAL SUPPLY WITH FEED-THROUGH BLOCKS UP TO 35 MM<sup>2</sup>



$I_{\max E}$ :  $I_{\max}$  supply  
 $I_{\max R}$ :  $I_{\text{reducing cross connector}}$   
 $I_{N-A}$ :  $I_N$  output terminal blocks

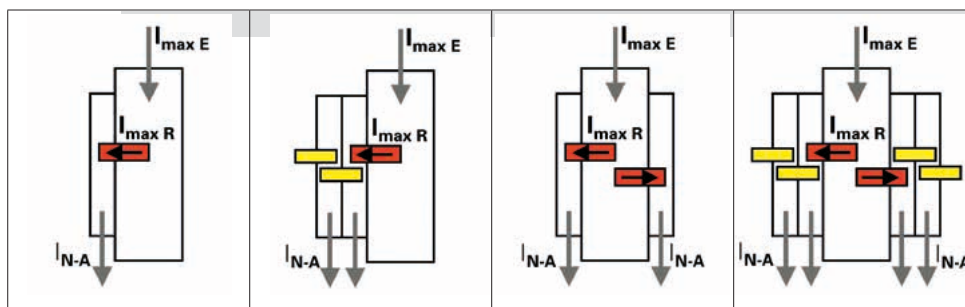

Potential distribution	Distribution on one side		Distribution on both sides	
	2-poles	several poles	2-poles	several poles
35-R-10 $I_{\max}$ supply	125 A	125 A	125 A	125 A
$I_{\text{reducing cross connector}}$	57 A	105 A	57 A	105 A
$I_N$ output terminal blocks	57 A	57 A	57 A	57 A

## POTENTIAL DISTRIBUTION 35 R 10

- Potential supply 35 mm<sup>2</sup>
- Reducing cross connector 35R10
- Potential output 10 mm<sup>2</sup>

Function	Type	Part No.	Std. Pack
Supply block	gray WKF 35 /35	56.735.0053.0	10
Supply block	gray WKF 35 /35 BLAU	56.735.0053.6	10
Reducing cross connector <sup>2)</sup>	IVB WKFN 35R10	27.285.6427.0	10
Output block	gray WKFN 10 /35	56.710.0055.0	10
Output block	blue WKFN 10 /35 BLAU	56.710.0055.6	10
Output block	gray WKFN 10 D1/2/35	56.710.5055.0	10
Output block	blue WKFN 10 D1/2/35 BLAU	56.710.5055.6	10

<sup>2)</sup> When cross connectors are used acc. to EN 60079-0 and EN 60079-7 the current must be reduced (values to be requested)

## ACCESSORIES FOR FASIS WKFN 16... AND WKF 35



ACCESSORIES	Type	Part No.	Std. Pack
Test plug	ST 2/2,3	Z5.553.2921.0	10
Screwdriver, uninsulated	DIN 5264 B 1x5,5	06.502.4200.0	5



\*\* When cross connectors are used according to EN 60079-0 and EN 60079-7, the current must be reduced to max. 3.5 A.

# GROUND BLOCKS WITH TENSION SPRING CONNECTION

## WKF 1,5 SL/35

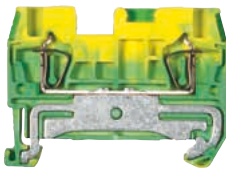
- Ground block with tension spring connection for mounting on TS 35
- Nominal cross section 1.5 mm<sup>2</sup>
- Ex e I/II  II 2GD IM2  
Follow the EX installation instructions on page 174





Description	Type	Part No.	Std. Pack
Ground block	green/yellow	WKF 1,5 SL/35	56.702.9053.0 50
GENERAL DATA			
Width / length / height, incl. TS 7.5	4 mm / 49 mm / 37 mm		
Wire strip length	10 mm		
Approvals	ATEX   KEMA 03 ATEX 2056 U		
TECHNICAL DATA			
	IEC	UL	CSA
			
Cross section fine-stranded	EN 60 947-7-2		
Cross section solid/stranded	EN 60 079-0/-7		
Cross section, AWG	0.08 – 1.5 mm <sup>2</sup>		
Rated current	0.14 – 1.5 mm <sup>2</sup>		
Rated voltage	0.14 – 1.5 mm <sup>2</sup>		
Rated impulse voltage	24 – 14	24 – 14	
Pollution degree	3	3	3
	500 V	300 V	300 V
	6 kV		440 V*
ACCESSORIES			
	Type	Part No.	Std. Pack
End plate	gray	APF 1,5	07.312.8153.0 10
Partition	gray	TWF 1,5	07.312.8253.0 10

## WKF 1,5 D1/2/SL/35

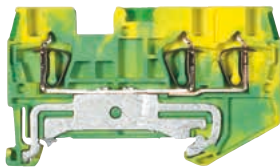
- Duo ground block with tension spring connection for mounting on TS 35
- Nominal cross section 1.5 mm<sup>2</sup>
- Ex e I/II  II 2GD IM2  
Follow the EX installation instructions on page 174





Description	Type	Part No.	Std. Pack
Ground block	green/yellow	WKF 1,5 D1/2/SL/35	56.702.9353.0 50
GENERAL DATA			
Width / length / height, incl. TS 7.5	4 mm / 60 mm / 37 mm		
Wire strip length	10 mm		
Approvals	ATEX   KEMA 03 ATEX 2056 U		
TECHNICAL DATA			
	IEC	UL	CSA
			
Cross section fine-stranded	EN 60 947-7-2		
Cross section solid/stranded	EN 60 079-0/-7		
Cross section, AWG	0.08 – 1.5 mm <sup>2</sup>		
Rated current	0.14 – 1.5 mm <sup>2</sup>		
Rated voltage	0.14 – 1.5 mm <sup>2</sup>		
Rated impulse voltage	24 – 14	24 – 14	
Pollution degree	3	3	3
	500 V	300 V	300 V
	6 kV		440 V*
ACCESSORIES			
	Type	Part No.	Std. Pack
End plate	gray	APF 1,5 D1/2	07.312.8353.0 10
Segment end plate		SAPF 1,5	07.312.8953.0 10
Partition	gray	TWF 1,5 D1/2	07.312.8453.0 10

## WKF 1,5 D2/2/SL/35

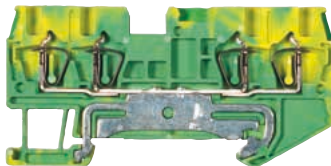
- Duo ground block with tension spring connection for mounting on TS 35
- Nominal cross section 1.5 mm<sup>2</sup>
- Ex e I/II  II 2GD IM2  
Follow the EX installation instructions on page 174



Description	Type	Part No.	Std. Pack
Ground block	green/yellow	WKF 1,5 D2/2/SL/35	56.702.9153.0 50
GENERAL DATA			
Width / length / height, incl. TS 7.5	4 mm / 72 mm / 37 mm		
Wire strip length	10 mm		
Approvals	ATEX   KEMA 03 ATEX 2056 U		
TECHNICAL DATA			
	IEC	UL	CSA
			
Cross section fine-stranded	EN 60 947-7-2		
Cross section solid/stranded	EN 60 079-0/-7		
Cross section, AWG	0.08 – 1.5 mm <sup>2</sup>		
Rated current	0.14 – 1.5 mm <sup>2</sup>		
Rated voltage	0.14 – 1.5 mm <sup>2</sup>		
Rated impulse voltage	24 – 14	24 – 14	
Pollution degree	3	3	3
	500 V	300 V	300 V
	6 kV		440 V*
ACCESSORIES			
	Type	Part No.	Std. Pack
End plate	gray	APF 1,5 D2/2	07.312.8553.0 10
Segment end plate		SAPF 1,5	07.312.8953.0 10
Partition	gray	TWF 1,5 D2/2	07.312.8653.0 10

## ACCESSORIES FOR FASIS WKF 1,5...

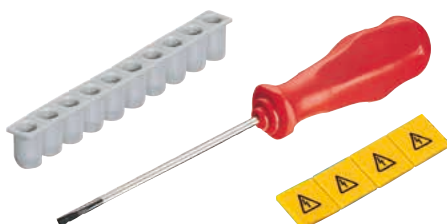

ACCESSORIES	Type	Part No.	Std. Pack
Wire entry guide	0.13 – 0.2 mm <sup>2</sup>	LEL 1,5/1 WEISS	05.564.4253.0 100
	0.25 – 0.5 mm <sup>2</sup>	LEL 1,5/2 GRAU	05.564.4353.0 100
Cover with warning symbol over 5 blocks	yellow	ADF 1,5/5 GELB	04.343.6953.8 10
Screwdriver, uninsulated		DIN 5264 B 0,4x2,5	06.502.4300.0 5

\* In order to maintain the proper isolation distances, the open side of a ground block is to be covered by an end plate.



### WKFN 2,5 SL/35

- Ground block with tension spring connection for mounting on TS 35
- Nominal cross section 2.5 mm<sup>2</sup>
- Ex e I/II II 2GD IM2  
Follow the EX installation instructions on page 174

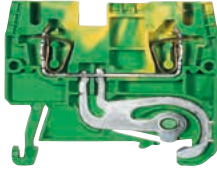

Description	Type	Part No.	Std. Pack
Ground block	green/yellow	WKFN 2,5 SL/35	56.703.9055.0 100
<b>GENERAL DATA</b>			
Width / length / height, incl. TS 7.5	5 mm / 47 mm / 38 mm		
Wire strip length	11 mm		
Approvals			PTB 04 ATEX 1051 U
<b>TECHNICAL DATA</b>			
	<b>IEC</b>	<b>UL</b>	<b>CSA</b>
Cross section fine-stranded	EN 60 947-7-2		EN 60 079-0/-7
Cross section solid/stranded	0.13 – 2.5 mm <sup>2</sup>		0.2 – 2.5 mm <sup>2</sup>
Cross section, AWG	0.13 – 4 mm <sup>2</sup>		0.13 – 4 mm <sup>2</sup>
Rated current		22 – 12	24 – 12
Rated voltage	800 V	600 V	600 V
Rated impulse voltage	8 kV		
Pollution degree	3		
<b>ACCESSORIES</b>			
End plate	gray	APFN 2,5	07.312.6755.0 10

### WKFN 2,5 D1/2/SL/35

- Duo-Ground block with tension spring connection for mounting on TS 35
- Nominal cross section 2.5 mm<sup>2</sup>
- Ex e I/II II 2GD IM2  
Follow the EX installation instructions on page 174

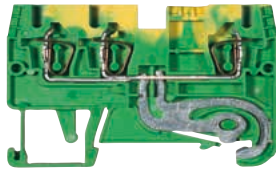

Description	Type	Part No.	Std. Pack
Ground block	green/yellow	WKFN 2,5 D1/2/SL/35	56.703.9355.0 100
<b>GENERAL DATA</b>			
Width / length / height, incl. TS 7.5	5 mm / 60 mm / 38 mm		
Wire strip length	11 mm		
Approvals			PTB 04 ATEX 1051 U
<b>TECHNICAL DATA</b>			
	<b>IEC</b>	<b>UL</b>	<b>CSA</b>
Cross section fine-stranded	EN 60 947-7-2		EN 60 079-0/-7
Cross section solid/stranded	0.13 – 2.5 mm <sup>2</sup>		0.2 – 2.5 mm <sup>2</sup>
Cross section, AWG	0.13 – 4 mm <sup>2</sup>		0.13 – 4 mm <sup>2</sup>
Rated current		22 – 12	24 – 12
Rated voltage	800 V	600 V	600 V
Rated impulse voltage	8 kV		
Pollution degree	3		
<b>ACCESSORIES</b>			
End plate	gray	APFN 2,5 D1/2	07.312.6955.0 10

### WKFN 2,5 D2/2/SL/35

- Duo ground block with tension spring connection for mounting on TS 35
- Nominal cross section 2.5 mm<sup>2</sup>
- Ex e I/II II 2GD IM2  
Follow the EX installation instructions on page 174

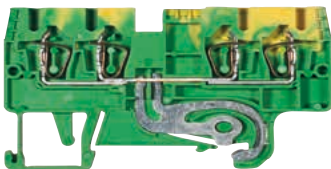

Description	Type	Part No.	Std. Pack
Ground block	green/yellow	WKFN 2,5 D2/2/SL/35	56.703.9155.0 100
<b>GENERAL DATA</b>			
Width / length / height, incl. TS 7.5	5 mm / 72 mm / 38 mm		
Wire strip length	11 mm		
Approvals			PTB 04 ATEX 1051 U
<b>TECHNICAL DATA</b>			
	<b>IEC</b>	<b>UL</b>	<b>CSA</b>
Cross section fine-stranded	EN 60 947-7-2		EN 60 079-0/-7
Cross section solid/stranded	0.13 – 2.5 mm <sup>2</sup>		0.2 – 2.5 mm <sup>2</sup>
Cross section, AWG	0.13 – 4 mm <sup>2</sup>		0.13 – 4 mm <sup>2</sup>
Rated current		22 – 12	24 – 12
Rated voltage	800 V	600 V	600 V
Rated impulse voltage	8 kV		
Pollution degree	3		
<b>ACCESSORIES</b>			
End plate	gray	APFN 2,5 D2/2	07.312.7155.0 10

## ACCESSORIES FOR FASIS WKFN 2,5...

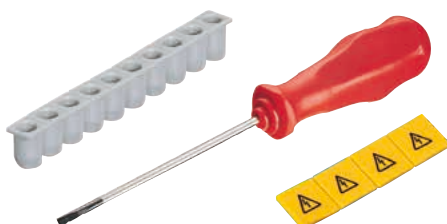







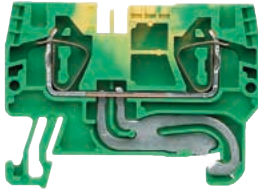

ACCESSORIES	Type	Part No.	Std. Pack
Wire entry guide	0.13 – 0.2 mm <sup>2</sup>	LELN 2,5/1 WEISS	05.564.3755.0 100
	0.25 – 0.5 mm <sup>2</sup>	LELN 2,5/2 GRAU	05.564.3855.0 100
	0.75 – 1.0 mm <sup>2</sup>	LELN 2,5/3 SCHWARZ	05.564.3955.0 100
Cover with warning symbol over 4 blocks	yellow	ADFN 2,5/4 GELB	04.343.8353.8 10
Screwdriver, uninsulated		DIN 5264 B 0,6x3,5	06.502.4000.0 5
Screwdriver, uninsulated, MINI		DIN 5264 B 0,6x3,5 M	06.502.5000.0 10

# GROUND BLOCKS WITH TENSION SPRING CONNECTION

## WKFN 4 SL/35

- Ground block with tension spring connection for mounting on TS 35
- Nominal cross section 4 mm<sup>2</sup>
- Ex e I/II  II 2GD IM2  
Follow the EX installation instructions on page 174











Description	Type	Part No.	Std. Pack
Ground block	green/yellow WKFN 4 SL/35	56.704.9055.0	100
<b>GENERAL DATA</b>			
Width / length / height, incl. TS 7.5	6 mm / 51 mm / 38 mm		
Wire strip length	11 mm		
Approvals	      		PTB 05 ATEX 1104 U
<b>TECHNICAL DATA</b>			
	<b>IEC</b>	<b>UL</b>	<b>CSA</b>
			
	EN 60 947-7-2		
Cross section fine-stranded	0.13 – 4 mm <sup>2</sup>		
Cross section solid/stranded	0.13 – 6 mm <sup>2</sup>		
Cross section, AWG	24 – 10		
Rated current	24 – 10		
Rated voltage	800 V		
Rated impulse voltage	8 kV		
Pollution degree	3		
<b>ACCESSORIES</b>			
End plate	gray APFN 4	07.312.9255.0	10

## WKFN 4 D1/2/SL/35

- Duo ground block with tension spring connection for mounting on TS 35
- Nominal cross section 4 mm<sup>2</sup>
- Ex e I/II  II 2GD IM2  
Follow the EX installation instructions on page 174









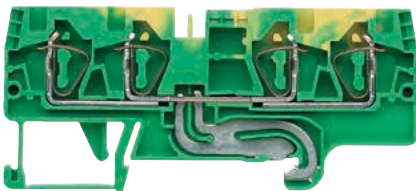

Description	Type	Part No.	Std. Pack
Ground block	green/yellow WKFN 4 D1/2/SL/35	56.704.9355.0	100
<b>GENERAL DATA</b>			
Width / length / height, incl. TS 7.5	6 mm / 67 mm / 38 mm		
Wire strip length	11 mm		
Approvals	      		PTB 05 ATEX 1104 U
<b>TECHNICAL DATA</b>			
	<b>IEC</b>	<b>UL</b>	<b>CSA</b>
			
	EN 60 947-7-2		
Cross section fine-stranded	0.13 – 4 mm <sup>2</sup>		
Cross section solid/stranded	0.13 – 6 mm <sup>2</sup>		
Cross section, AWG	24 – 10		
Rated current	24 – 10		
Rated voltage	800 V		
Rated impulse voltage	8 kV		
Pollution degree	3		
<b>ACCESSORIES</b>			
End plate	gray APFN 4 D1/2	07.312.9455.0	10

## WKFN 4 D2/2/SL/35

- Duo ground block with tension spring connection for mounting on TS 35
- Nominal cross section 4 mm<sup>2</sup>
- Ex e I/II  II 2GD IM2  
Follow the EX installation instructions on page 174



Description	Type	Part No.	Std. Pack
Ground block	green/yellow WKFN 4 D2/2/SL/35	56.704.9155.0	100
<b>GENERAL DATA</b>			
Width / length / height, incl. TS 7.5	6 mm / 82 mm / 38 mm		
Wire strip length	11 mm		
Approvals	      		PTB 05 ATEX 1104 U
<b>TECHNICAL DATA</b>			
	<b>IEC</b>	<b>UL</b>	<b>CSA</b>
			
	EN 60 947-7-2		
Cross section fine-stranded	0.13 – 4 mm <sup>2</sup>		
Cross section solid/stranded	0.13 – 6 mm <sup>2</sup>		
Cross section, AWG	24 – 10		
Rated current	24 – 10		
Rated voltage	800 V		
Rated impulse voltage	8 kV		
Pollution degree	3		
<b>ACCESSORIES</b>			
End plate	gray APFN 4 D2/2	07.312.9055.0	10

## ACCESSORIES FOR FASIS WKFN 4...

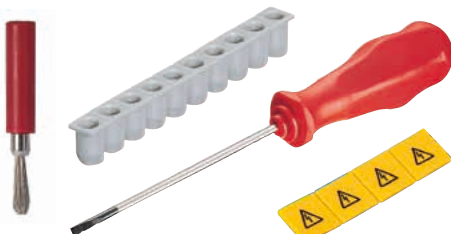

ACCESSORIES	Type	Part No.	Std. Pack
Wire entry guide	0.13 – 0.2 mm <sup>2</sup>	LEL 4/1 WEISS	05.561.8553.0
	0.25 – 0.5 mm <sup>2</sup>	LEL 4/2 GRAU	05.561.8653.0
	0.75 – 1.0 mm <sup>2</sup>	LEL 4/3 SCHWARZ	05.561.8753.0
Cover with warning symbol over 4 blocks	yellow	ADF 4/4 GELB	04.343.6153.8
Test plug		ST 2/2,3	Z5.553.2921.0
Screwdriver, uninsulated		DIN 5264 B 0,6x3,5	06.502.4000.0
Screwdriver, uninsulated, MINI		DIN 5264 B 0,6x3,5 M	06.502.5000.0

### WKFN 6 SL/35

- Ground block with tension spring connection for mounting on TS 35
- Nominal cross section 6 mm<sup>2</sup>
- Ex e I/II II 2GD IM2  
Follow the EX installation instructions on page 174

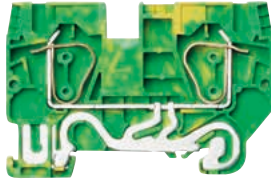

Description	Type	Part No.	Std. Pack
Ground block	green/yellow WKFN 6 SL/35	56.706.9055.0	100
<b>GENERAL DATA</b>			
Width / length / height, incl. TS 7.5	8 mm / 66 mm / 45 mm		
Wire strip length	12 mm		
Approvals	PTB		PTB 06 ATEX 1075 U
<b>TECHNICAL DATA</b>			
	<b>IEC</b>	<b>UL</b>	<b>CSA</b>
	EN 60 947-7-2		EN 60 079-0/-7
Cross section fine-stranded	0.2 – 6 mm <sup>2</sup>		0.2 – 6 mm <sup>2</sup>
Cross section solid/stranded	1.5 – 10 mm <sup>2</sup>		1.5 – 10 mm <sup>2</sup>
Cross section, AWG	24 – 8		24 – 8
Rated current			
Rated voltage	800 V	600 V	600 V
Rated impulse voltage	8 kV		
Pollution degree	3		
<b>ACCESSORIES</b>			
	<b>Type</b>	<b>Part No.</b>	<b>Std. Pack</b>
End plate	gray APFN 6	07.313.0455.0	10

### WKFN 6 D1/2/SL/35

- Duo ground block with tension spring connection for mounting on TS 35
- Nominal cross section 6 mm<sup>2</sup>
- Ex e I/II II 2GD IM2  
Follow the EX installation instructions on page 174

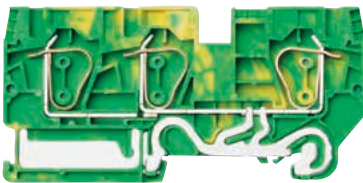

Description	Type	Part No.	Std. Pack
Ground block	green/yellow WKFN 6 D1/2/SL/35	56.706.9355.0	100
<b>GENERAL DATA</b>			
Width / length / height, incl. TS 7.5	8 mm / 90 mm / 45 mm		
Wire strip length	12 mm		
Approvals	PTB		PTB 06 ATEX 1075 U
<b>TECHNICAL DATA</b>			
	<b>IEC</b>	<b>UL</b>	<b>CSA</b>
	EN 60 947-7-2		EN 60 079-0/-7
Cross section fine-stranded	0.2 – 6 mm <sup>2</sup>		0.2 – 6 mm <sup>2</sup>
Cross section solid/stranded	1.5 – 10 mm <sup>2</sup>		1.5 – 10 mm <sup>2</sup>
Cross section, AWG	24 – 8		24 – 8
Rated current	50 A		
Rated voltage	800 V	600 V	600 V
Rated impulse voltage	8 kV		
Pollution degree	3		
<b>ACCESSORIES</b>			
	<b>Type</b>	<b>Part No.</b>	<b>Std. Pack</b>
End plate	gray APFN 6 D1/2	07.313.0655.0	10

## ACCESSORIES FOR FASIS WKFN 6...

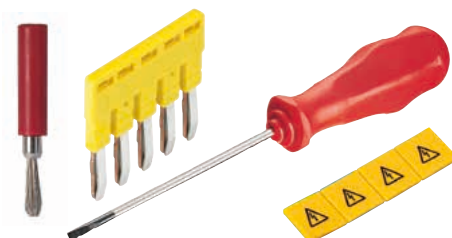

ACCESSORIES	Type	Part No.	Std. Pack
Cross connector, insulated*	2-pole	IVB WKFN 6 – 2	Z7.282.5227.0
	3-pole	IVB WKFN 6 – 3	Z7.282.5327.0
	4-pole	IVB WKFN 6 – 4	Z7.282.5427.0
	5-pole	IVB WKFN 6 – 5	Z7.282.5527.0
	Cover with warning symbol over 4 blocks	yellow	ADF 6/4 GELB
Test plug		ST 2/2,3	Z5.553.2921.0
Screwdriver, uninsulated		DIN 5264 B 0,8x4	06.502.4100.0





\* When cross connectors are used according to EN 60079-0 and EN 60079-7, the current must be reduced to max. 3.5 A.

# GROUND BLOCKS WITH TENSION SPRING CONNECTION

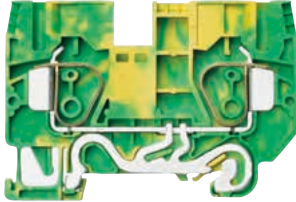
## WKFN 10 SL/35

- Ground block with tension spring connection for mounting on TS 35
- Nominal cross section 10 mm<sup>2</sup>
- Ex e I/II  II 2GD IM2  
Follow the EX installation instructions on page 174





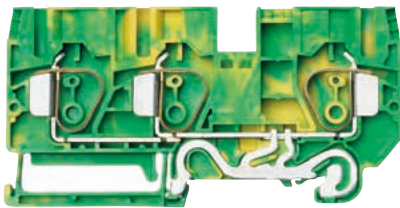

Description	Type	Part No.	Std. Pack
Ground block	green/yellow	WKFN 10 SL/35	56.710.9055.0 50
<b>GENERAL DATA</b>			
Width / length / height, incl. TS 7.5	10 mm / 72 mm / 50 mm		
Wire strip length	15 mm		
Approvals	PTB   		PTB 06 ATEX 1075 U
<b>TECHNICAL DATA</b>			
	<b>IEC</b>	<b>UL</b>	<b>CSA</b> 
	EN 60 947-7-2		
Cross section fine-stranded	0.2 – 10 mm <sup>2</sup>		EN 60 079-0/-7 0.2 – 10 mm <sup>2</sup>
Cross section solid/stranded	1.5 – 16 mm <sup>2</sup>		1.5 – 16 mm <sup>2</sup>
Cross section, AWG	16 – 6		16 – 6
Rated current			
Rated voltage	1000 V	600 V	600 V
Rated impulse voltage	8 kV		
Pollution degree	3		
<b>ACCESSORIES</b>			
End plate	gray	APFN 10/35	07.313.0855.0 10

## WKFN 10 D1/2/SL/35

- Duo ground block with tension spring connection for mounting on TS 35
- Nominal cross section 10 mm<sup>2</sup>
- Ex e I/II  II 2GD IM2  
Follow the EX installation instructions on page 174





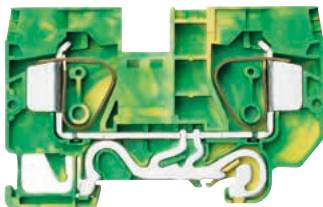

Description	Type	Part No.	Std. Pack
Ground block	green/yellow	WKFN 10 D1/2/SL/35	56.710.9355.0 50
<b>GENERAL DATA</b>			
Width / length / height, incl. TS 7.5	10 mm / 98 mm / 50 mm		
Wire strip length	15 mm		
Approvals	PTB   		PTB 06 ATEX 1075 U
<b>TECHNICAL DATA</b>			
	<b>IEC</b>	<b>UL</b>	<b>CSA</b> 
	EN 60 947-7-2		
Cross section fine-stranded	0.2 – 10 mm <sup>2</sup>		EN 60 079-0/-7 0.2 – 10 mm <sup>2</sup>
Cross section solid/stranded	1.5 – 16 mm <sup>2</sup>		1.5 – 16 mm <sup>2</sup>
Cross section, AWG			16 – 6
Rated current			
Rated voltage	1000 V	600 V	
Rated impulse voltage	8 kV		
Pollution degree	3		
<b>ACCESSORIES</b>			
End plate	gray	APFN 10 D1/2	07.313.1055.0 10

## WKFN 16 SL/35

- Ground block with tension spring connection for mounting on TS 35
- Nominal cross section 16 mm<sup>2</sup>
- Ex e I/II  II 2GD IM2  
Follow the EX installation instructions on page 174



Description	Type	Part No.	Std. Pack
Ground block	green/yellow	WKFN 16 SL/35	56.716.9055.0 50
<b>GENERAL DATA</b>			
Width / length / height, incl. TS 7.5	12 mm / 79 mm / 50 mm		
Wire strip length	16 mm		
Approvals	PTB   		PTB 06 ATEX 1075 U
<b>TECHNICAL DATA</b>			
	<b>IEC</b>	<b>UL</b>	<b>CSA</b> 
	EN 60 947-7-2		
Cross section fine-stranded	0.2 – 16 mm <sup>2</sup>		EN 60 079-0/-7 0.2 – 16 mm <sup>2</sup>
Cross section solid/stranded	1.5 – 25 mm <sup>2</sup>		1.5 – 25 mm <sup>2</sup>
Cross section, AWG	16 – 4		16 – 4
Rated current			
Rated voltage	1000 V	600 V	600 V
Rated impulse voltage	8 kV		
Pollution degree	3		
<b>ACCESSORIES</b>			
End plate	gray	APFN 16	07.313.1255.0 10

### WKFN 16 D1/2/SL/35

- Duo ground block with tension spring connection for mounting on TS 35
- Nominal cross section 16 mm<sup>2</sup>
- Ex e II (Ex) II 2GD IM2  
Follow the EX installation instructions on page 174

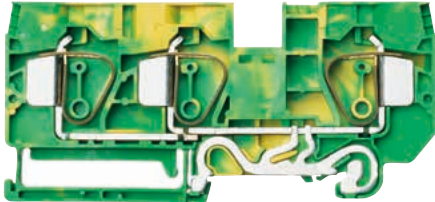

Description	Type	Part No.	Std. Pack	
Ground block	green/yellow	WKFN 16 D1/2/SL/35	56.716.9355.0	50
<b>GENERAL DATA</b>				
Width / length / height, incl. TS 7.5	12 mm / 107 mm / 50 mm			
Wire strip length	16 mm			
Approvals	PTB		PTB 06 ATEX 1075 U	
<b>TECHNICAL DATA</b>				
	<b>IEC</b>	<b>UL</b>	<b>CSA</b>	<b>(Ex)</b>
	EN 60 947-7-2			EN 60 079-0/-7
Cross section fine-stranded	0.2 – 16 mm <sup>2</sup>		0.2 – 16 mm <sup>2</sup>	
Cross section solid/stranded	1.5 – 25 mm <sup>2</sup>		1.5 – 25 mm <sup>2</sup>	
Cross section, AWG			16 – 4	
Rated current				
Rated voltage	1000 V		600 V	
Rated impulse voltage	8 kV			
Pollution degree	3			
<b>ACCESSORIES</b>				
End plate	gray	APFN 16 D1/2	07.313.1455.0	10

### WKF 35 SL/35

- Ground block with tension spring connection for mounting on TS 35
- Nominal cross section 35 mm<sup>2</sup>
- Ex e II (Ex) II 2GD  
Follow the EX installation instructions on page 174



Description	Type	Part No.	Std. Pack	
Ground block	green/yellow	WKF 35 SL/35	56.735.9053.0	10
<b>GENERAL DATA</b>				
Width / length / height, incl. TS 7.5	16 mm / 100 mm / 59 mm			
Wire strip length	25 mm			
Approvals	ATEX		KEMA 03 ATEX 2057 U	
<b>TECHNICAL DATA</b>				
	<b>IEC</b>	<b>UL</b>	<b>CSA</b>	<b>(Ex)</b>
	EN 60 947-7-1			EN 60 079-0/-7
Cross section fine-stranded	2.5 – 35 mm <sup>2</sup>		2.5 – 35 mm <sup>2</sup>	
Cross section solid/stranded	2.5 – 35 mm <sup>2</sup>		2.5 – 35 mm <sup>2</sup>	
Cross section, AWG	12 – 2		12 – 2	
Rated current				
Rated voltage	800 V	600 V	600 V	690 V
Rated impulse voltage	8 kV			
Pollution degree	3			
<b>ACCESSORIES</b>				
Cross connector, insulated	2-pole	IVB WKF 35 – 2	Z7.285.6227.0	10
Cover with warning symbol over 4 blocks		ADF 35/5 GELB	04.343.9253.8	10
Test plug		ST 2/2,3	Z5.553.2921.0	10

## ACCESSORIES FOR FASIS WKFN 10 SL/... AND WKFN 16 SL/...

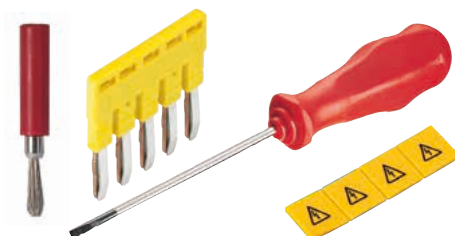

ACCESSORIES	Type	Part No.	Std. Pack	
Test plug	ST 2/2,3	Z5.553.2921.0	10	
Screwdriver, uninsulated	DIN 5264 B 1x5,5	06.502.4200.0	5	
<b>for WKFN 10 ...</b>				
Cross connector, insulated**	2-pole	IVB WKF 10 – 2	Z7.283.8227.0	10
Cover with warning symbol over 4 blocks	yellow	ADF 10/4 GELB	04.343.6453.8	10
<b>for WKFN 16 ...</b>				
Cross connector, insulated*	2-pole	IVB WKF 16 – 2	Z7.284.4227.0	10
Cover with warning symbol over 4 blocks	yellow	ADF 16/4 GELB	04.343.6653.8	10

\*\* When cross connectors are used acc. to EN 60079-0 and EN 60079-7 the current must be reduced to 4 A/40 K or 5 A/45 K for type WKFN 10/35.





# MULTI-TIER TERMINAL BLOCKS WITH TENSION SPRING CONNECTION

## WKF 1,5 E2/35

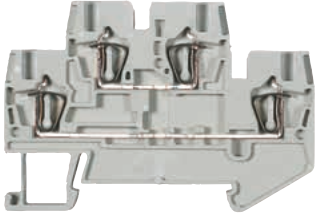
- Multi-tier block with tension spring connection for mounting on TS 35
- Nominal cross section 1.5 mm<sup>2</sup>
- Ex e II  II 2GD  
Follow the EX installation instructions on page 174





Description	Type	Part No.	Std. Pack
Multi-tier block	gray WKF 1,5 E2/35	56.702.7653.0	50
<b>GENERAL DATA</b>			
Width / length / height, incl. TS 7.5	4 mm / 68 mm / 47 mm		
Wire strip length	10 mm		
Approvals	ATEX   KEMA 03 ATEX 2056 U		
<b>TECHNICAL DATA</b>			
	<b>IEC</b>	<b>UL</b>	<b>CSA</b>
			
Cross section fine-stranded	EN 60 947-7-1		EN 60 079-0/-7
Cross section solid/stranded	0.08 – 1.5 mm <sup>2</sup>		0.14 – 1.5 mm <sup>2</sup>
Cross section, AWG		26 – 14	26 – 14
Rated current	17,5 A	15 A	15 A
Rated voltage	500 V	300 V	300 V
Rated impulse voltage	6 kV		440 V <sup>2)</sup>
Pollution degree	3		
<b>ACCESSORIES</b>			
	<b>Type</b>	<b>Part No.</b>	<b>Std. Pack</b>
End plate	gray APF 1,5 E2	07.312.8753.0	10
Partition	gray TWF 1,5 E2	07.312.8853.0	10
Cross connector, insulated	2-pole IVB WKF 1,5 – 2	Z7.268.0227.0	10
	5-pole IVB WKF 1,5 – 5	Z7.268.0527.0	10
	10-pole IVB WKF 1,5 – 10	Z7.268.1027.0	10
	20-pole IVB WKF 1,5 – 20	Z7.268.2027.0	10
Marking tag carrier, 2-fold	BT 4/2	04.243.0953.0	100

## WKF 1,5 E2/VB/35

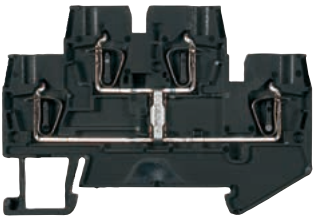
- Multi-tier block, vertically connected, with tension spring connection for mounting on TS 35
- Nominal cross section 1.5 mm<sup>2</sup>
- Ex e II  II 2GD  
Follow the EX installation instructions on page 174





Description	Type	Part No.	Std. Pack
Multi-tier block	black WKF 1,5 E2/VB/35	56.702.6953.1	50
<b>GENERAL DATA</b>			
Width / length / height, incl. TS 7.5	4 mm / 68 mm / 47 mm		
Wire strip length	10 mm		
Approvals	ATEX   KEMA 03 ATEX 2056 U		
<b>TECHNICAL DATA</b>			
	<b>IEC</b>	<b>UL</b>	<b>CSA</b>
			
Cross section fine-stranded	EN 60 947-7-1		EN 60 079-0/-7
Cross section solid/stranded	0.08 – 1.5 mm <sup>2</sup>		0.14 – 1.5 mm <sup>2</sup>
Cross section, AWG		26 – 14	26 – 14
Rated current	17,5 A	15 A	15 A
Rated voltage	500 V	300 V	300 V
Rated impulse voltage	6 kV		440 V <sup>2)</sup>
Pollution degree	3		
<b>ACCESSORIES</b>			
	<b>Type</b>	<b>Part No.</b>	<b>Std. Pack</b>
End plate	gray APF 1,5 E2	07.312.8753.0	10
Partition	gray TWF 1,5 E2	07.312.8853.0	10
Cross connector, insulated	2-pole IVB WKF 1,5 – 2	Z7.268.0227.0	10
	5-pole IVB WKF 1,5 – 5	Z7.268.0527.0	10
	10-pole IVB WKF 1,5 – 10	Z7.268.1027.0	10
	20-pole IVB WKF 1,5 – 20	Z7.268.2027.0	10
Marking tag carrier, 2-fold	BT 4/2	04.243.0953.0	100

## WKF 1,5 E2/SL/35

- Multi-tier ground block with tension spring connection for mounting on TS 35
- Nominal cross section 1.5 mm<sup>2</sup>
- Ex e II  II 2GD  
Follow the EX installation instructions on page 174



Description	Type	Part No.	Std. Pack
Multi-tier ground block	green/yellow WKF 1,5 E2/SL/35	56.702.9253.0	50
<b>GENERAL DATA</b>			
Width / length / height, incl. TS 7.5	4 mm / 68 mm / 47 mm		
Wire strip length	10 mm		
Approvals	ATEX   KEMA 03 ATEX 2056 U		
<b>TECHNICAL DATA</b>			
	<b>IEC</b>	<b>UL</b>	<b>CSA</b>
			
Cross section fine-stranded	EN 60 947-7-2		EN 60 079-0/-7
Cross section solid/stranded	0.08 – 1.5 mm <sup>2</sup>		0.14 – 1.5 mm <sup>2</sup>
Cross section, AWG		26 – 14	26 – 14
Rated current			
Rated voltage	500 V	300 V	300 V
Rated impulse voltage	6 kV		
Pollution degree	3		
<b>ACCESSORIES</b>			
	<b>Type</b>	<b>Part No.</b>	<b>Std. Pack</b>
End plate	gray APF 1,5 E2	07.312.8753.0	10
Partition	gray TWF 1,5 E2	07.312.8853.0	10
Wire entry guide	0.13 – 0.2 mm <sup>2</sup> LEL 1,5/1 WEISS	05.564.4253.0	10
	0.25 – 0.5 mm <sup>2</sup> LEL 1,5/2 GRAU	05.564.4353.0	10
Cover with warning symbol over 5 blocks	ADF 1,5/5 GELB	04.343.6953.8	10
Marking tag carrier, 2-fold	BT 4/2	04.243.0953.0	100

<sup>1)</sup> Rated current when using cross connectors

<sup>2)</sup> For maintaining the proper isolation distances, the open side of a feed-through terminal block as well as both sides of a jumper are to be covered by partitions.





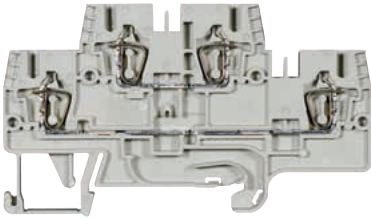

# MULTI-TIER BLOCKS WITH TENSION SPRING CONNECTION

## WKFN 2,5 E/35 WKFN 2,5 E/N/D/35

- Multi-tier block with tension spring connection for mounting on TS 35
- Nominal cross section 2.5 mm<sup>2</sup>
- Ex e I/II  II 2GD IM2  
Follow the EX installation instructions on page 174



Description	Type	Part No.	Std. Pack
Multi-tier block	gray	WKFN 2,5 E/35	56.703.7055.0 100
Multi-tier block, combined	gray	WKFN 2,5 E/N/D/35	56.703.7655.0 100

GENERAL DATA				
Width / length / height, incl. TS 7.5	5 mm / 82 mm / 48 mm			
Wire strip length	11 mm			
Approvals	     			PTB 04 ATEX 1051 U
TECHNICAL DATA				
	IEC	UL	CSA	
	EN 60 947-7-1			
Cross section fine-stranded	0.13 – 2.5 mm <sup>2</sup>			
Cross section solid/stranded	0.13 – 4 mm <sup>2</sup>			
Cross section, AWG		22 – 12	24 – 12	
Rated current	24 A	20 A	24 A	20/21,5 A <sup>1)</sup>
Rated voltage	500 V	300 V	300 V	440/275 V <sup>2)</sup>
Rated impulse voltage	6 kV			
Pollution degree	3			
<b>Note</b>	<sup>1)</sup> 1. value at 40K / 2. value at 45K <sup>2)</sup> When using cross connectors on the upper tier			

### WKFN 2,5 E/N/D/35





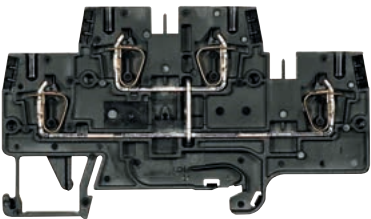

	Function	Color ID
Upper tier	Feed-through	blue
Lower tier	Feed-through	gray

## WKFN 2,5 E/VB/35

- Multi-tier block, vertically connected, with tension spring connection for mounting on TS 35
- Nominal cross section 2.5 mm<sup>2</sup>
- Ex e I/II  II 2GD IM2  
Follow the EX installation instructions on page 174



Description	Type	Part No.	Std. Pack
Multi-tier block	black	WKFN 2,5 E/VB/35	56.703.6955.1 100





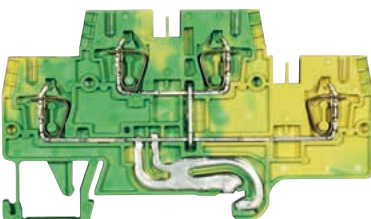

GENERAL DATA				
Width / length / height, incl. TS 7.5	5 mm / 82 mm / 48 mm			
Wire strip length	11 mm			
Approvals	     			PTB 04 ATEX 1051 U
TECHNICAL DATA				
	IEC	UL	CSA	
	EN 60 947-7-1			
Cross section fine-stranded	0.13 – 2.5 mm <sup>2</sup>			
Cross section solid/stranded	0.13 – 4 mm <sup>2</sup>			
Cross section, AWG		22 – 12	24 – 12	
Rated current	24 A	20 A	24 A	20/21,5 A <sup>1)</sup>
Rated voltage	500 V	600 V	600 V	440 V
Rated impulse voltage	6 kV			
Pollution degree	3			
<b>Note</b>	<sup>1)</sup> 1. value at 40K / 2. value at 45K			

## WKFN 2,5 E/SL/35

- Ground block with tension spring connection for mounting on TS 35
- Nominal cross section 2.5 mm<sup>2</sup>
- Ex e I/II  II 2GD IM2  
Follow the EX installation instructions on page 174



Description	Type	Part No.	Std. Pack
Ground block	green/yellow	WKFN 2,5 E/SL/35	56.703.8955.0 100

GENERAL DATA				
Width / length / height, incl. TS 7.5	5 mm / 82 mm / 48 mm			
Wire strip length	11 mm			
Approvals	     			PTB 04 ATEX 1051 U
TECHNICAL DATA				
	IEC	UL	CSA	
	EN 60 947-7-2			
Cross section fine-stranded	0.13 – 2.5 mm <sup>2</sup>			
Cross section solid/stranded	0.13 – 4 mm <sup>2</sup>			
Cross section, AWG		22 – 12	24 – 12	
Rated current				
Rated voltage	500 V	600 V	600 V	
Rated impulse voltage	6 kV			
Pollution degree	3			

# MULTI-TIER BLOCKS WITH TENSION SPRING CONNECTION

## WKFN 2,5 E-K

- Multi-tier block with tension spring connection for mounting on TS 35
- Nominal cross section 2.5 mm<sup>2</sup>

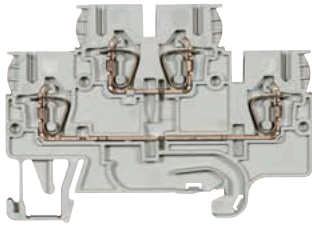

Description	Type	Part No.	Std. Pack	
Multi-tier block	gray	WKFN 2,5 E-K	56.703.4755.0	100
<b>GENERAL DATA</b>				
Width / length / height, incl. TS 7.5	5 mm / 68 mm / 48 mm			
Wire strip length	11 mm			
Approvals				
<b>TECHNICAL DATA</b>				
	<b>IEC</b>	<b>UL</b>	<b>CSA</b>	
	EN 60 947-7-1	pending	pending	
Cross section fine-stranded	0.13 – 2.5 mm <sup>2</sup>			
Cross section solid/stranded	0.13 – 4 mm <sup>2</sup>			
Cross section, AWG				
Rated current	24 A			
Rated voltage	500 V			
Rated impulse voltage	6 kV			
Pollution degree	3			
<b>ACCESSORIES</b>				
End plate	gray	APFN 2,5 E-K	07.313.5155.0	10

## WKFN 2,5 EVB-K

- Multi-tier block, vertically connected, with tension spring connection for mounting on TS 35
- Nominal cross section 2.5 mm<sup>2</sup>

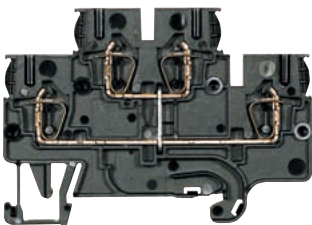

Description	Type	Part No.	Std. Pack	
Multi-tier block	black	WKFN 2,5 EVB-K	56.703.4855.1	100
<b>GENERAL DATA</b>				
Width / length / height, incl. TS 7.5	5 mm / 68 mm / 48 mm			
Wire strip length	11 mm			
Approvals				
<b>TECHNICAL DATA</b>				
	<b>IEC</b>	<b>UL</b>	<b>CSA</b>	
	EN 60 947-7-1	pending	pending	
Cross section fine-stranded	0.13 – 2.5 mm <sup>2</sup>			
Cross section solid/stranded	0.13 – 4 mm <sup>2</sup>			
Cross section, AWG				
Rated current	24 A			
Rated voltage	500 V			
Rated impulse voltage	6 kV			
Pollution degree	3			
<b>ACCESSORIES</b>				
End plate	gray	APFN 2,5 E-K	07.313.5155.0	10

## WKFN 2,5 ESL-K

- Ground block with tension spring connection for mounting on TS 35
- Nominal cross section 2.5 mm<sup>2</sup>

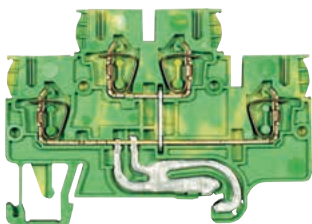

Description	Type	Part No.	Std. Pack	
Ground block	green/yellow	WKFN 2,5 ESL-K	56.703.4955.0	100
<b>GENERAL DATA</b>				
Width / length / height, incl. TS 7.5	5 mm / 68 mm / 42 mm			
Wire strip length	11 mm			
Approvals				
<b>TECHNICAL DATA</b>				
	<b>IEC</b>	<b>UL</b>	<b>CSA</b>	
	EN 60 947-7-2	pending	pending	
Cross section fine-stranded	0.13 – 2.5 mm <sup>2</sup>			
Cross section solid/stranded	0.13 – 4 mm <sup>2</sup>			
Cross section, AWG				
Rated current				
Rated voltage	500 V			
Rated impulse voltage	6 kV			
Pollution degree	3			
<b>ACCESSORIES</b>				
End plate	gray	APFN 2,5 E-K	07.313.5155.0	10

## WKFN 2,5 E/D/SL/35 WKFN 2,5 E/N/SL/35

- Multi-tier block, combined, with tension spring connection for mounting on TS 35
- Nominal cross section 2.5 mm<sup>2</sup>

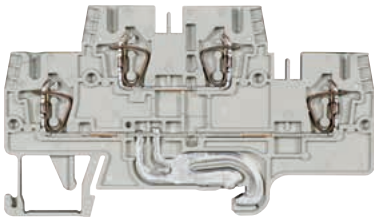

Description	Type	Part No.	Std. Pack
Multi-tier block, combined	gray	WKFN 2,5 E/D/SL/35	56.703.7855.0
Multi-tier block, combined	gray	WKFN 2,5 E/N/SL/35	56.703.7755.0

GENERAL DATA			
Width / length / height, incl. TS 7.5	5 mm / 82 mm / 48 mm		
Wire strip length	11 mm		
Approvals			
TECHNICAL DATA			
	IEC	UL	CSA
Cross section fine-stranded	EN 60 947-7-1		
Cross section solid/stranded	0.13 – 2.5 mm <sup>2</sup>		
Cross section, AWG	22 – 12		
Rated current	24 A	20 A	24 A
Rated voltage	500 V	300 V	300 V
Rated impulse voltage	6 kV		
Pollution degree	3		

### WKFN 2,5 E/D/SL/35

	Function	Color ID
Upper tier	Feed-through	gray
Lower tier	Ground conductor	green/yellow

### WKFN 2,5 E/N/SL/35

	Function	Color ID
Upper tier	Feed-through	blue
Lower tier	Ground conductor	green/yellow

## WKFN 2,5 E...G

- Multi-tier function block with tension spring connection for mounting on TS 35
- Nominal cross section 2.5 mm<sup>2</sup>

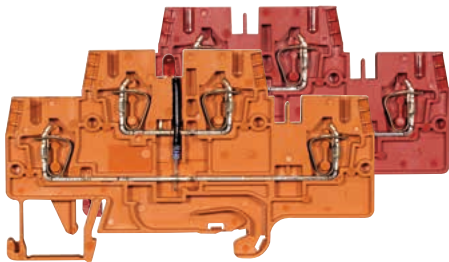

Description	Type	Part No.	Std. Pack
Multi-tier function block	red	WKFN 2,5 E.../35	56.703.XX55.5
Multi-tier function block	orange	WKFN 2,5 E.../35	56.703.XX55.9

GENERAL DATA			
Width / length / height, incl. TS 7.5	5 mm / 82 mm / 48 mm		
Wire strip length	11 mm		
Approvals			
TECHNICAL DATA			
	IEC	UL	CSA
Cross section fine-stranded	EN 60 947-7-1		
Cross section solid/stranded	0.13 – 2.5 mm <sup>2</sup>		
Cross section, AWG	22 – 12		

## FUNCTION DIAGRAM FOR FASIS WKFN 2,5 E...

The multi-tier block is available on request as a function block for a wide variety of switching tasks.

56.703.7555.9 56.703.7555.5					
56.703.8255.5		I = 1 A U = 1000 V	56.703.7455.9 LED red		R = 4.7 kΩ P = 0.5 W U = 24 V DC
56.703.7155.5 56.703.7155.9				56.703.7255.5 LED red	R = 4.7 kΩ P = 0.5 W U = 24 V DC
56.703.8155.9		I = 1 A U = 1000 V	56.703.8355.5		R = 680 kΩ P = 0.25 W U = 100-500 V

## ACCESSORIES FOR FASIS WKFN 2,5 E/...

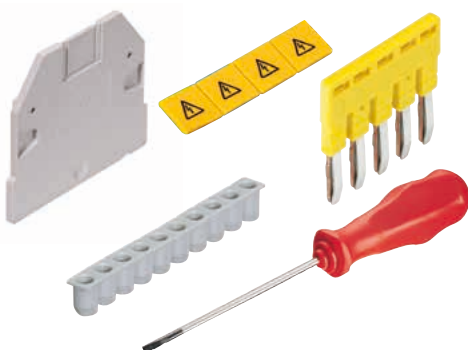







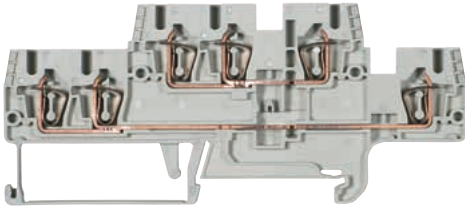

ACCESSORIES	Type	Part No.	Std. Pack
End plate	gray	APFN 2,5 E	07.312.7355.0
Partition	gray	WFN 2,5 E	07.312.7455.0
Cross connector, insulated	2-pole	IVB WKF 2,5 – 2	Z7.280.6227.0
	3-pole	IVB WKF 2,5 – 3	Z7.280.6327.0
	4-pole	IVB WKF 2,5 – 4	Z7.280.6427.0
	5-pole	IVB WKF 2,5 – 5	Z7.280.6527.0
	10-pole	IVB WKF 2,5 – 10	Z7.280.7027.0
	20-pole	IVB WKF 2,5 – 20	Z7.280.8027.0
Vertical cross connector	1-pole	IVB WKF – V	Z7.261.1127.0
Wire entry guide	0.13 – 0.2 mm <sup>2</sup>	LELN 2,5/1 WEISS	05.564.3755.0
	0.25 – 0.5 mm <sup>2</sup>	LELN 2,5/2 GRAU	05.564.3855.0
	0.75 – 1.0 mm <sup>2</sup>	LELN 2,5/3 SCHWARZ	05.564.3955.0
Cover with warning symbol over 4 blocks	yellow	ADFN 2,5/4 GELB	04.343.8353.8
Marking tag carrier, 3-fold		BT 5/3	04.243.0755.0

# DUO MULTI-TIER TERMINAL BLOCKS WITH TENSION SPRING CONNECTION

## WKFN 2,5 E1/2/35 WKFN 2,5 E1/2/N/D/35

- Duo multi-tier block with tension spring connection for mounting on TS 35
- Nominal cross section 2.5 mm<sup>2</sup>
- Ex e I/II  II 2GD IM2  
Follow the EX installation instructions on page 174









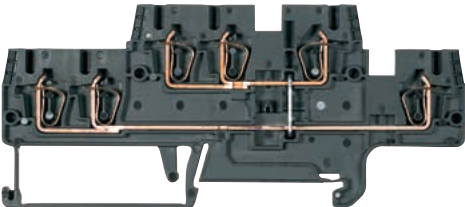

Description	Type	Part No.	Std. Pack
Multi-tier block	gray	WKFN 2,5 E1/2/35	56.703.6055.0 50
Multi-tier block, combined	gray	WKFN 2,5 E1/2/N/D/35	56.703.6355.0 50
GENERAL DATA			
Width / length / height, incl. TS 7.5	5 mm / 107 mm / 48 mm		
Wire strip length	11 mm		
Approvals	PTB       		PTB 04 ATEX 1051 U
TECHNICAL DATA			
	IEC	UL	CSA
			
Cross section fine-stranded	EN 60 947-7-1		
Cross section solid/stranded	0.13 – 2.5 mm <sup>2</sup>		
Cross section, AWG	0.13 – 4 mm <sup>2</sup>		
Rated current	22 – 12	24 – 12	
Rated voltage	22 A	20 A	24 A
Rated impulse voltage	500 V	300 V	300 V
Pollution degree	6 kV	300 V	440/275 V <sup>2)</sup>
	3		
<b>Note</b>	<sup>1)</sup> 1. value at 40K / 2. value at 45K <sup>2)</sup> When using cross connectors on the upper tier		

## WKFN 2,5 E1/2/VB/35

- Duo multi-tier block, vertically connected, with tension spring connection for mounting on TS 35
- Nominal cross section 2.5 mm<sup>2</sup>
- Ex e I/II  II 2GD IM2  
Follow the EX installation instructions on page 174









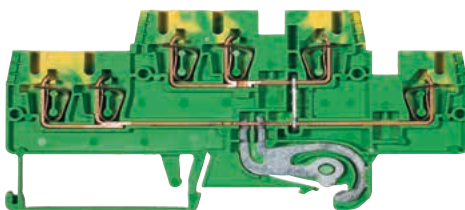

Description	Type	Part No.	Std. Pack
Multi-tier block	black	WKFN 2,5 E1/2/VB/35	56.703.5955.1 50
GENERAL DATA			
Width / length / height, incl. TS 7.5	5 mm / 107 mm / 48 mm		
Wire strip length	11 mm		
Approvals	PTB       		PTB 04 ATEX 1051 U
TECHNICAL DATA			
	IEC	UL	CSA
			
Cross section fine-stranded	EN 60 947-7-1		
Cross section solid/stranded	0.13 – 2.5 mm <sup>2</sup>		
Cross section, AWG	0.13 – 4 mm <sup>2</sup>		
Rated current	22 – 12	24 – 12	
Rated voltage	22 A	20 A	24 A
Rated impulse voltage	500 V	300 V	300 V
Pollution degree	6 kV	300 V	440 V
	3		
<b>Note</b>	<sup>1)</sup> 1. value at 40K / 2. value at 45K		
ACCESSORIES			
Partition	gray	TWFN 2,5 E1/2	07.312.7855.0 10

## WKFN 2,5 E1/2/SL/35

- Duo multi-tier ground block with tension spring connection for mounting on TS 35
- Nominal cross section 2.5 mm<sup>2</sup>
- Ex e I/II  II 2GD IM2  
Follow the EX installation instructions on page 174



Description	Type	Part No.	Std. Pack
Ground block	green/yellow	WKFN 2,5 E1/2/SL/35	56.703.6255.0 50
GENERAL DATA			
Width / length / height, incl. TS 7.5	5 mm / 107 mm / 48 mm		
Wire strip length	11 mm		
Approvals	PTB       		PTB 04 ATEX 1051 U
TECHNICAL DATA			
	IEC	UL	CSA
			
Cross section fine-stranded	EN 60 947-7-2		
Cross section solid/stranded	0.13 – 2.5 mm <sup>2</sup>		
Cross section, AWG	0.13 – 4 mm <sup>2</sup>		
Rated current	22 – 12	24 – 12	
Rated voltage	500 V	600 V	600 V
Rated impulse voltage	6 kV	600 V	
Pollution degree	3		



## WKFN 2,5 E1/2/D/SL/35 WKFN 2,5 E1/2/N/SL/35

- Duo multi-tier block, combined, with tension spring connection for mounting on TS 35
- Nominal cross section 2.5 mm<sup>2</sup>

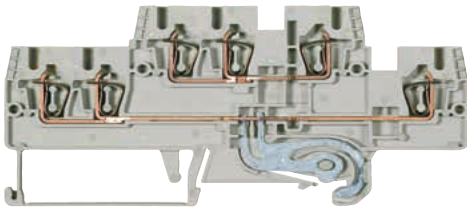

Description	Type	Part No.	Std. Pack
Multi-tier block, combined	gray	WKFN 2,5 E1/2/D/SL/35	56.703.6155.0
Multi-tier block, combined	gray	WKFN 2,5 E1/2/N/SL/35	56.703.6455.0

GENERAL DATA			
Width / length / height, incl. TS 7.5	5 mm / 107 mm / 48 mm		
Wire strip length	11 mm		
Approvals			

TECHNICAL DATA		IEC	UL	CSA
		EN 60 947-7-1		
Cross section fine-stranded	0.13 – 2.5 mm <sup>2</sup>			
Cross section solid/stranded	0.13 – 4 mm <sup>2</sup>			
Cross section, AWG			22 – 12	24 – 12
Rated current	22 A		20 A	24 A
Rated voltage	500 V		300 V	300 V
Rated impulse voltage	6 kV			
Pollution degree	3			

### WKFN 2,5 E1/2/35 Block color: gray

	Function	Color ID
Upper tier	Feed-through	gray
Lower tier	Feed-through	gray

### WKFN 2,5 E1/2/D/SL/35 Block color: gray

	Function	Color ID
Upper tier	Feed-through	gray
Lower tier	Ground conductor	green/yellow

### WKFN 2,5 E1/2/N/D/35 Block color: gray

	Function	Color ID
Upper tier	Feed-through	blue
Lower tier	Feed-through	gray

### WKFN 2,5 E1/2/N/SL/35 Block color: gray

	Function	Color ID
Upper tier	Feed-through	blue
Lower tier	Ground conductor	green/yellow

### WKFN 2,5 E1/2/VB/35 Block color: black

	Function	Color ID
Upper tier	Feed-through	black
Lower tier	vert. jumpered	black

### WKFN 2,5 E1/2/SL/35 Block color: green/yellow

	Function	Color ID
Upper tier	Ground conductor	green/yellow
Lower tier	vert. jumpered	green/yellow

## ACCESSORIES FOR FASIS WKFN 2,5 E1/2/...







ACCESSORIES	Type	Part No.	Std. Pack
End plate	gray APFN 2,5 E1/2	07.312.7755.0	10
Partition	gray TWFN 2,5 E1/2	07.312.7855.0	10
Cross connector, insulated	2-pole IVB WKF 2,5 – 2	Z7.280.6227.0	10
	3-pole IVB WKF 2,5 – 3	Z7.280.6327.0	10
	4-pole IVB WKF 2,5 – 4	Z7.280.6427.0	10
	5-pole IVB WKF 2,5 – 5	Z7.280.6527.0	10
	10-pole IVB WKF 2,5 – 10	Z7.280.7027.0	20
	20-pole IVB WKF 2,5 – 20	Z7.280.8027.0	20
Vertical cross connector	1-pole IVB WKF-V	Z7.261.1127.0	10
Wire entry guide	0.13 – 0.2 mm <sup>2</sup> LELN 2,5/1 WEISS	05.564.3755.0	100
	0.25 – 0.5 mm <sup>2</sup> LELN 2,5/2 GRAU	05.564.3855.0	100
	0.75 – 1.0 mm <sup>2</sup> LELN 2,5/3 SCHWARZ	05.564.3955.0	100
Cover with warning symbol over 4 blocks	yellow ADFN 2,5/4 GELB	04.343.8353.8	10
Marking tag carrier, 2-fold	BT 5/2	04.243.0855.0	100
Test adapter, modular	PS WKC/F	Z1.299.9753.0	10
Test plug	ST 2/2,3	Z5.553.2921.0	10
Screwdriver, uninsulated	DIN 5264 B 0,6x3,5	06.502.4000.0	5
Screwdriver, uninsulated, MINI	DIN 5264 B 0,6x3,5 M	06.502.5000.0	10

# MULTI-TIER TERMINAL BLOCKS WITH TENSION SPRING CONNECTION

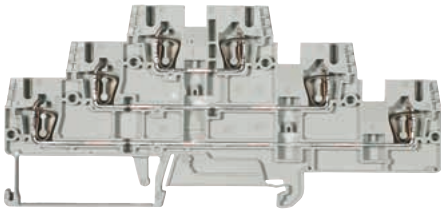
## WKFN 2,5 E3/35

- Multi-tier block with tension spring connection for mounting on TS 35
- Nominal cross section 2.5 mm<sup>2</sup>
- Ex e I/II  II 2GD IM2  
Follow the EX installation instructions on page 174





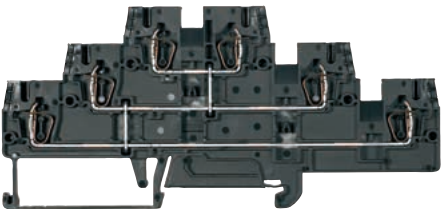

Description	Type	Part No.	Std. Pack
Multi-tier block	gray WKFN 2,5 E3/35	56.703.3055.0	50
<b>GENERAL DATA</b>			
Width / length / height, incl. TS 7.5	5 mm / 123 mm / 59 mm		
Wire strip length	11 mm		
Approvals	   		PTB 04 ATEX 1051 U
<b>TECHNICAL DATA</b>			
	<b>IEC</b>	<b>UL</b>	<b>CSA</b>
	EN 60 947-7-1		
Cross section fine-stranded	0.13 – 2.5 mm <sup>2</sup>		EN 60 079-0/-7
Cross section solid/stranded	0.13 – 4 mm <sup>2</sup>		0.2 – 2.5 mm <sup>2</sup>
Cross section, AWG	22 – 12		24 – 12
Rated current	20 A	20 A	24 A
Rated voltage	500 V	300 V	300 V
Rated impulse voltage	6 kV		440/275 V <sup>1)</sup>
Pollution degree	3		
<b>Note</b>	<sup>1)</sup> 1. value at 40 K / 2. value at 45 K <sup>2)</sup> When using cross connectors on the upper tier		

## WKFN 2,5 E3/VB/35

- Multi-tier block, vertically connected, with tension spring connection for mounting on TS 35
- Nominal cross section 2.5 mm<sup>2</sup>
- Ex e I/II  II 2GD IM2  
Follow the EX installation instructions on page 174





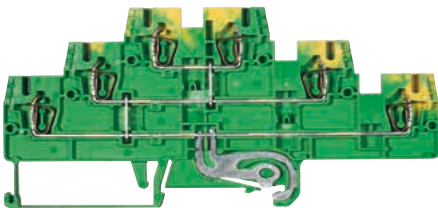

Description	Type	Part No.	Std. Pack
Multi-tier block	black WKFN 2,5 E3/VB/35	56.703.2955.1	50
<b>GENERAL DATA</b>			
Width / length / height, incl. TS 7.5	5 mm / 123 mm / 59 mm		
Wire strip length	11 mm		
Approvals	   		PTB 04 ATEX 1051 U
<b>TECHNICAL DATA</b>			
	<b>IEC</b>	<b>UL</b>	<b>CSA</b>
	EN 60 947-7-1		
Cross section fine-stranded	0.13 – 2.5 mm <sup>2</sup>		EN 60 079-0/-7
Cross section solid/stranded	0.13 – 4 mm <sup>2</sup>		0.2 – 2.5 mm <sup>2</sup>
Cross section, AWG	22 – 12		24 – 12
Rated current	20 A	20 A	24 A
Rated voltage	500 V	600 V	600 V
Rated impulse voltage	6 kV		440 V
Pollution degree	3		
<b>Note</b>	<sup>1)</sup> 1. value at 40 K / 2. value at 45 K		

## WKFN 2,5 E3/SL/35

- Multi-tier ground block with tension spring connection for mounting on TS 35
- Nominal cross section 2,5 mm<sup>2</sup>
- Ex e I/II  II 2GD IM2  
Follow the EX installation instructions on page 174



Description	Type	Part No.	Std. Pack
Multi-tier ground block	green/yellow WKFN 2,5 E/SL/35	56.703.8855.0	50
<b>GENERAL DATA</b>			
Width / length / height, incl. TS 7.5	5 mm / 123 mm / 59 mm		
Wire strip length	11 mm		
Approvals	   		PTB 04 ATEX 1051 U
<b>TECHNICAL DATA</b>			
	<b>IEC</b>	<b>UL</b>	<b>CSA</b>
	EN 60 947-7-2		
Cross section fine-stranded	0.13 – 2.5 mm <sup>2</sup>		EN 60 079-0/-7
Cross section solid/stranded	0.13 – 4 mm <sup>2</sup>		0.2 – 2.5 mm <sup>2</sup>
Cross section, AWG	22 – 12		24 – 12
Rated current			
Rated voltage	500 V	600 V	600 V
Rated impulse voltage	6 kV		
Pollution degree	3		

# MULTI-TIER / MOTOR CONNECTION BLOCK WITH TENSION SPRING CONNECTION



## WKFN 2,5 E3/D/D/SL/35

## WKFN 2,5 E3/N/D/SL/35

- Multi-tier block, combined, with tension spring connection for mounting on TS 35
- Nominal cross section 2.5 mm<sup>2</sup>

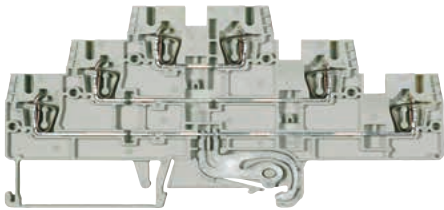

Description	Type	Part No.	Std. Pack
Multi-tier block	gray WKFN 2,5 E3/D/D/SL/35	56.703.3355.0	50
Multi-tier block	gray WKFN 2,5 E3/N/D/SL/35	56.703.3255.0	50

### GENERAL DATA

Width / length / height, incl. TS 7.5	5 mm / 123 mm / 59 mm
Wire strip length	11 mm
Approvals	

### TECHNICAL DATA

IEC	UL	CSA
EN 60 947-7-1		
Cross section fine-stranded		
Cross section solid/stranded		
Cross section, AWG	22 – 12	24 – 12
Rated current	20 A	24 A
Rated voltage	500 V	300 V
Rated impulse voltage	6 kV	
Pollution degree	3	

### WKFN 2,5 E3/N/D/SL/35

Block color: gray

	Function	Color ID
Upper tier	Feed-through	blue
Center tier	Feed-through	gray
Lower tier	Ground conductor	green/yellow

### WKFN 2,5 E3/D/D/SL/35

Block color: gray

	Function	Color ID
Upper tier	Feed-through	gray
Center tier	Feed-through	gray
Lower tier	Ground conductor	green/yellow

## WKF 4 3D/SL

- Motor connection block with tension spring connection for mounting on TS 35
- Nominal cross section 4 mm<sup>2</sup>



Description	Type	Part No.	Std. Pack
Motor connection block	gray WKF 4 3D/SL	56.704.8453.0	50

### GENERAL DATA

Width / length / height, incl. TS 7.5	6 mm / 100 mm / 84 mm
Wire strip length	10 mm
Approvals	

### TECHNICAL DATA

IEC	UL	CSA
EN 60 947-7-1/DIN VDE 0611 T1		
Cross section fine-stranded		
Cross section solid/stranded		
Cross section, AWG	28 – 10	28 – 10
Rated current	28 A	30 A
Rated voltage	800 V	600 V
Rated impulse voltage	8 kV	
Pollution degree	3	

## ACCESSORIES FOR FASIS WKFN 2,5 E3/...

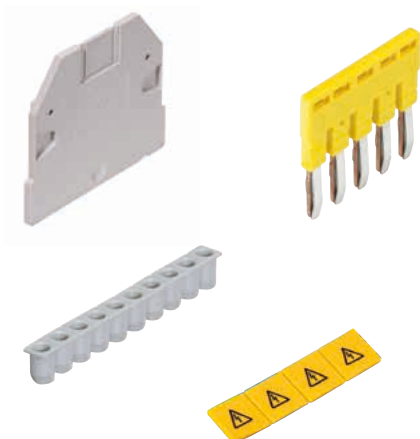

ACCESSORIES	Type	Part No.	Std. Pack
End plate	gray APFN 2,5 E3	07.312.7555.0	10
Partition	gray TWFN 2,5 E3	07.312.7655.0	10
Cross connector, insulated	2-pole	IVB WKFN 2,5 – 2	27.280.6227.0
	3-pole	IVB WKFN 2,5 – 3	27.280.6327.0
	4-pole	IVB WKFN 2,5 – 4	27.280.6427.0
	5-pole	IVB WKFN 2,5 – 5	27.280.6527.0
	10-pole	IVB WKFN 2,5 – 10	27.280.7027.0
	20-pole	IVB WKFN 2,5 – 20	27.280.8027.0
Vertical cross connector	1-pole	IVB WKFN-V	27.261.1127.0
Wire entry guide	0.13 – 0.2 mm <sup>2</sup>	LELN 2,5/1 WEISS	05.564.3755.0
	0.25 – 0.5 mm <sup>2</sup>	LELN 2,5/2 GRAU	05.564.3855.0
	0.75 – 1.0 mm <sup>2</sup>	LELN 2,5/3 SCHWARZ	05.564.3955.0
Cover with warning symbol over 4 blocks	yellow	ADFN 2,5/4 GELB	04.343.8353.8
Marking tag carrier, 2-fold		BT 5/2	04.243.0855.0

# MULTI-TIER TERMINAL BLOCKS WITH TENSION SPRING CONNECTION



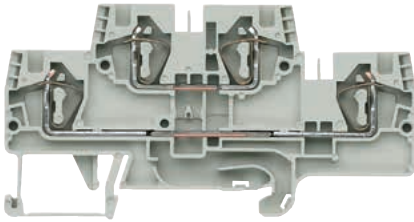

## WKFN 4 E/35

### WKFN 4 E/N/D/35

- Multi-tier block with tension spring connection for mounting on TS 35
- Nominal cross section 4 mm<sup>2</sup>
- Ex e/I/II  II 2GD IM2  
Follow the EX installation instructions on page 174



Description	Type	Part No.	Std. Pack
Multi-tier block	gray	WKFN 4 E/35	56.704.7055.0
Multi-tier block, combined	gray	WKFN 4 E/N/D/35	56.704.7655.0

GENERAL DATA					
Width / length / height, incl. TS 7.5	6 mm / 90 mm / 48 mm				
Wire strip length	11 mm				
Approvals	   			PTB 05 ATEX 1104 U	
TECHNICAL DATA		IEC	UL	CSA	
		EN 60 947-7-1			EN 60 079-0/-7
Cross section fine-stranded		0.13 – 4 mm <sup>2</sup>			0.13 – 4 mm <sup>2</sup>
Cross section solid/stranded		0.13 – 6 mm <sup>2</sup>			0.2 – 6 mm <sup>2</sup>
Cross section, AWG			24 – 10	24 – 10	
Rated current		32 A	30 A	32 A	27/29 A <sup>1)2)</sup>
Rated voltage		500 V	300 V	300 V	440/352 V <sup>3)</sup>
Rated impulse voltage		6 kV			
Pollution degree		3			

**Note**

<sup>1)</sup> 1. value at 40 K / 2. value at 45 K  
<sup>2)</sup> When cross connectors are used acc. to EN 60079-0 and EN 60079-7 the current must be reduced to 2 A at 45 K.  
<sup>3)</sup> When using cross connectors on the upper tier

WKFN 4 E/N/D/35 Block color: gray



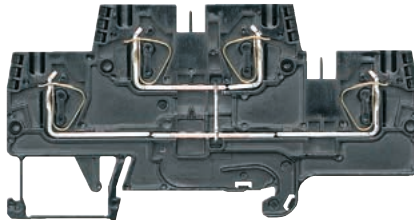

	Function	Color ID
Upper tier	Feed-through	blue
Lower tier	Feed-through	gray

## WKFN 4 E/VB/35

- Multi-tier block, vertically connected, with tension spring connection for mounting on TS 35
- Nominal cross section 4 mm<sup>2</sup>
- Ex e/I/II  II 2GD IM2  
Follow the EX installation instructions on page 174



Description	Type	Part No.	Std. Pack
Multi-tier block	black	WKFN 4 E/VB/35	56.704.6955.1

GENERAL DATA					
Width / length / height, incl. TS 7.5	6 mm / 90 mm / 48 mm				
Wire strip length	11 mm				
Approvals	   			PTB 05 ATEX 1104 U	
TECHNICAL DATA		IEC	UL	CSA	
		EN 60 947-7-1			EN 60 079-0/-7
Cross section fine-stranded		0.13 – 4 mm <sup>2</sup>			0.13 – 4 mm <sup>2</sup>
Cross section solid/stranded		0.13 – 6 mm <sup>2</sup>			0.2 – 6 mm <sup>2</sup>
Cross section, AWG			24 – 10	24 – 10	
Rated current		32 A	30 A	32 A	30/31 A <sup>1)</sup>
Rated voltage		500 V	600 V	300 V	440 V
Rated impulse voltage		6 kV			
Pollution degree		3			



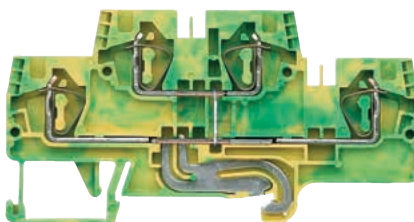

**Note** <sup>1)</sup> 1. value at 40 K / 2. value at 45 K

## WKFN 4 E/SL/35

- Multi-tier ground block with tension spring connection for mounting on TS 35
- Nominal cross section 4 mm<sup>2</sup>
- Ex e/I/II  II 2GD IM2  
Follow the EX installation instructions on page 174



Description	Type	Part No.	Std. Pack
Multi-tier ground block	green/yellow	WKFN 4 E SL/35	56.704.9255.0

GENERAL DATA					
Width / length / height, incl. TS 7.5	6 mm / 90 mm / 48 mm				
Wire strip length	11 mm				
Approvals	   			PTB 05 ATEX 1104 U	
TECHNICAL DATA		IEC	UL	CSA	
		EN 60 947-7-2			EN 60 079-0/-7
Cross section fine-stranded		0.13 – 4 mm <sup>2</sup>			0.13 – 4 mm <sup>2</sup>
Cross section solid/stranded		0.13 – 6 mm <sup>2</sup>			0.2 – 6 mm <sup>2</sup>
Cross section, AWG			24 – 10	24 – 10	
Rated current					
Rated voltage		500 V	600 V	600 V	
Rated impulse voltage		6 kV			
Pollution degree		3			

# MULTI-TIER TERMINAL BLOCKS WITH TENSION SPRING CONNECTION



## WKFN 4 E/D/SL/35 WKFN 4 E/N/SL/35

- Multi-tier block, combined, with tension spring connection for mounting on TS 35
- Nominal cross section 4 mm<sup>2</sup>
- Ex e I/II II 2GD IM2  
Follow the EX installation instructions on page 174

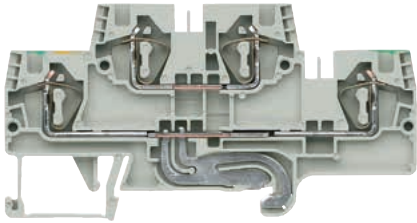

Description	Type	Part No.	Std. Pack
Multi-tier block, combined	gray WKFN 4 E/D/SL/35	56.704.7855.0	100
Multi-tier block, combined	gray WKFN 4 E/N/SL/35	56.704.7755.0	100

GENERAL DATA				
Width / length / height, incl. TS 7.5	6 mm / 90 mm / 48 mm			
Wire strip length	11 mm			
Approvals				
TECHNICAL DATA		IEC	UL	CSA
Cross section fine-stranded		EN 60 947-7-1		
Cross section solid/stranded		0.13 – 4 mm <sup>2</sup>		
Cross section, AWG		24 – 10		
Rated current		32 A		
Rated voltage		300 V		
Rated impulse voltage		6 kV		
Pollution degree		3		

WKFN 4 E/D/SL/35			WKFN 4 E/N/SL/35		
Block color: gray			Block color: gray		
	Function	Color ID		Function	Color ID
Upper tier	Feed-through	gray	Upper tier	Feed-through	blue
Lower tier	Ground conductor	green/yellow	Lower tier	Ground conductor	green/yellow

## WKFN 4 E /35...

- Multi-tier function block with tension spring connection for mounting on TS 35
- Nominal cross section 4 mm<sup>2</sup>

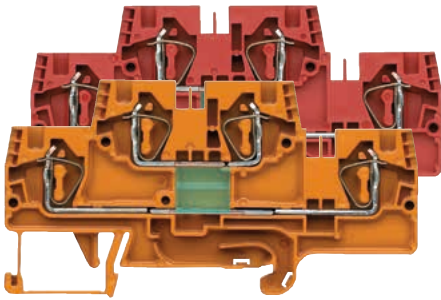

Description	Type	Part No.	Std. Pack
Multi-tier function block	red WKFN 4 E /35...	56.704.XX55.5	100
Multi-tier function block	orange WKFN 4 E /35...	56.704.XX55.9	100

GENERAL DATA				
Width / length / height, incl. TS 7.5	6 mm / 90 mm / 48 mm			
Wire strip length	11 mm			
Approvals				
TECHNICAL DATA		IEC	UL	CSA
Cross section fine-stranded		EN 60 947-7-1		
Cross section solid/stranded		0.13 – 4 mm <sup>2</sup>		
Cross section, AWG		24 – 10		

## FUNCTION DIAGRAM FOR FASIS WKFN 4 E/...

The multi-tier block is available on request as a function block for a wide variety of switching tasks.

56.704.7555.9 56.704.7555.5		56.704.8255.5		I = 1 A U = 1000 V	56.704.7455.9 LED red		R = 4.7 kΩ P = 0.5 W U = 24 V DC
56.704.7155.5 56.704.7155.9		56.704.7955.5		I = 1 A U = 1000 V	56.704.7255.5 LED red		R = 4.7 kΩ P = 0.5 W U = 24 V DC
56.704.8055.9		56.704.8355.5		I = 1 A U = 1000 V	56.704.7355.5		R = 680 kΩ P = 0.25 W U = 100-500 V

## ACCESSORIES FOR FASIS WKFN 4 E/...

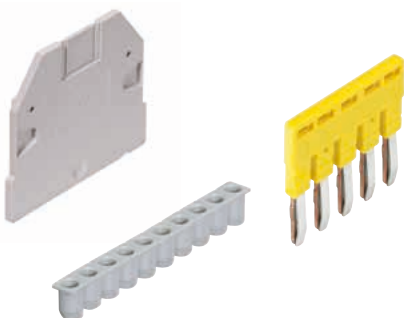

ACCESSORIES	Type	Part No.	Std. Pack
End plate	gray APFN 4 E...	07.312.9655.0	10
Partition	gray TWFN 4 E...	07.312.9755.0	10
Cross connector, insulated	2-pole	IVB WKF 4-2	Z7.261.1227.0
	3-pole	IVB WKF 4-3	Z7.261.1327.0
	4-pole	IVB WKF 4-4	Z7.261.1427.0
	5-pole	IVB WKF 4-5	Z7.261.1527.0
	6-pole	IVB WKF 4-6	Z7.261.1627.0
	7-pole	IVB WKF 4-7	Z7.261.1727.0
	8-pole	IVB WKF 4-8	Z7.261.1827.0
	9-pole	IVB WKF 4-9	Z7.261.1927.0
	10-pole	IVB WKF 4-10	Z7.261.2027.0
	Vertical cross connector, insulated	1-pole	IVB WKF-V
Wire entry guide	0.13 – 0.2 mm <sup>2</sup>	LEL 4/1 WEISS	05.561.8553.0
	0.25 – 0.5 mm <sup>2</sup>	LEL 4/2 GRAU	05.561.8653.0
	0.75 – 1.0 mm <sup>2</sup>	LEL 4/3 SCHWARZ	05.561.8753.0



# KNIFE DISCONNECT TERMINAL BLOCKS WITH TENSION SPRING CONNECTION

## WKFN 2,5 TKM/35

- Knife disconnect terminal block with tension spring connection for mounting on TS 35
- Nominal cross section 2.5 mm<sup>2</sup>

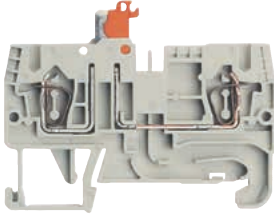

Description	Type	Part No.	Std. Pack
Disconnect terminal block	gray	WKFN 2,5 TKM/35	56.703.5355.0 100
<b>GENERAL DATA</b>			
Width / length / height, incl. TS 7.5	5 mm / 60 mm / 38 mm		
Wire strip length	11 mm		
Approvals			
<b>TECHNICAL DATA</b>			
	<b>IEC</b>	<b>UL</b>	<b>CSA</b>
	EN 60947-7-1		
Cross section fine-stranded	0.14 – 2.5 mm <sup>2</sup>		
Cross section solid/stranded	0.2 – 4 mm <sup>2</sup>		
Cross section, AWG	24 – 12	24 – 12	
Rated current	20 A	19 A	20 A
Rated voltage	630 V	300 V	300 V
Rated impulse voltage	6 kV		
Pollution degree	3		
<b>ACCESSORIES</b>			
	<b>Type</b>	<b>Part No.</b>	<b>Std. Pack</b>
End plate	gray APFN 2,5 D1/2	07.312.6955.0	10
Partition	gray TWFN 2,5 D1/2	07.312.7055.0	10

## WKFN 2,5 TKM 1/2/35

- Duo knife disconnect terminal block with tension spring connection for mounting on TS 35
- Nominal cross section 2.5 mm<sup>2</sup>



Description	Type	Part No.	Std. Pack
Disconnect terminal block	gray	WKFN 2,5 TKM 1/2/35	56.703.5455.0 100
<b>GENERAL DATA</b>			
Width / length / height, incl. TS 7.5	5 mm / 72 mm / 38 mm		
Wire strip length	11 mm		
Approvals			
<b>TECHNICAL DATA</b>			
	<b>IEC</b>	<b>UL</b>	<b>CSA</b>
	EN 60947-7-1		
Cross section fine-stranded	0.14 – 2.5 mm <sup>2</sup>		
Cross section solid/stranded	0.2 – 4 mm <sup>2</sup>		
Cross section, AWG	24 – 12	24 – 12	
Rated current	20 A	19 A	20 A
Rated voltage	630 V	300 V	300 V
Rated impulse voltage	6 kV		
Pollution degree	3		
<b>ACCESSORIES</b>			
	<b>Type</b>	<b>Part No.</b>	<b>Std. Pack</b>
End plate	gray APFN 2,5 D2/2	07.312.7155.0	10
Partition	gray TWFN 2,5 D2/2	07.312.7255.0	10

## WKFN 2,5 TKM 2/2/35

- Duo knife disconnect terminal block with tension spring connection for mounting on TS 35
- Nominal cross section 2.5 mm<sup>2</sup>

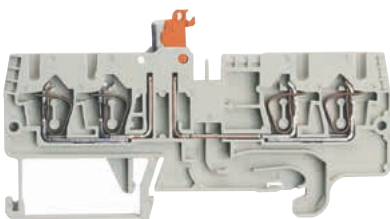

Description	Type	Part No.	Std. Pack
Disconnect terminal block	gray	WKFN 2,5 TKM 2/2/35	56.703.5555.0 100
<b>GENERAL DATA</b>			
Width / length / height, incl. TS 7.5	5 mm / 85 mm / 38 mm		
Wire strip length	11 mm		
Approvals			
<b>TECHNICAL DATA</b>			
	<b>IEC</b>	<b>UL</b>	<b>CSA</b>
	EN 60947-7-1		
Cross section fine-stranded	0.14 – 2.5 mm <sup>2</sup>		
Cross section solid/stranded	0.2 – 4 mm <sup>2</sup>		
Cross section, AWG	24 – 12	24 – 12	
Rated current	20 A	19 A	20 A
Rated voltage	630 V	300 V	300 V
Rated impulse voltage	6 kV		
Pollution degree	3		
<b>ACCESSORIES</b>			
	<b>Type</b>	<b>Part No.</b>	<b>Std. Pack</b>
End plate	gray APFN 2,5 TKM D2/2	07.313.0055.0	10
Partition	gray TWFN 2,5 TKM D2/2	07.313.0155.0	10

# MULTI-TIER DISCONNECT TERMINAL BLOCKS WITH TENSION SPRING CONNECTION

## WKFN 2,5 TKM E1/35

- Multi-tier disconnect terminal block with tension spring connection for mounting on TS 35
- Nominal cross section 2.5 mm<sup>2</sup>

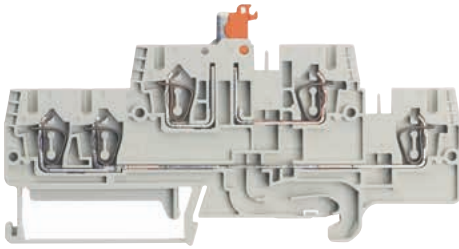

Description	Type	Part No.	Std. Pack	
Disconnect terminal block	gray	WKFN 2,5 TKM E1/35	56.703.6555.0	50
<b>GENERAL DATA</b>				
Width / length / height, incl. TS 7.5	5 mm / 107 mm / 48 mm			
Wire strip length	11 mm			
Approvals				
<b>TECHNICAL DATA</b>		<b>IEC</b>	<b>UL</b>	<b>CSA</b>
	EN 60947-7-1			
Cross section fine-stranded	0.14 – 2.5 mm <sup>2</sup>			
Cross section solid/stranded	0.2 – 4 mm <sup>2</sup>			
Cross section, AWG		24 – 12	24 – 12	
Rated current	20 A	19 A	20 A	
Rated voltage	500 V	300 V	300 V	
Rated impulse voltage	6 kV			
Pollution degree	3			
<b>ACCESSORIES</b>		<b>Type</b>	<b>Part No.</b>	<b>Std. Pack</b>
End plate	gray	APFN 2,5 E1/2	07.312.7755.0	10
Partition	gray	TWFN 2,5 E1/2	07.312.7855.0	10

## WKFN 2,5 TKM E2/35

- Multi-tier disconnect terminal block with tension spring connection for mounting on TS 35
- Nominal cross section 2.5 mm<sup>2</sup>

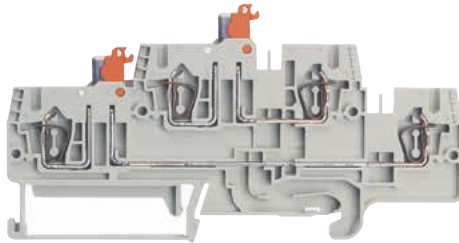

Description	Type	Part No.	Std. Pack	
Disconnect terminal block	gray	WKFN 2,5 TKM E2/35	56.703.6655.0	50
<b>GENERAL DATA</b>				
Width / length / height, incl. TS 7.5	5 mm / 107 mm / 48 mm			
Wire strip length	11 mm			
Approvals				
<b>TECHNICAL DATA</b>		<b>IEC</b>	<b>UL</b>	<b>CSA</b>
	EN 60947-7-1			
Cross section fine-stranded	0.14 – 2.5 mm <sup>2</sup>			
Cross section solid/stranded	0.2 – 4 mm <sup>2</sup>			
Cross section, AWG		24 – 12	24 – 12	
Rated current	19 A	19 A	19 A	
Rated voltage	500 V	300 V	300 V	
Rated impulse voltage	6 kV			
Pollution degree	3			
<b>Accessories</b>		<b>Type</b>	<b>Part No.</b>	<b>Std. Pack</b>
End plate	gray	APFN 2,5 E1/2	07.312.7755.0	10
Partition	gray	TWFN 2,5 E1/2	07.312.7855.0	10

## ACCESSORIES FOR FASIS WKFN 2,5 TKM...

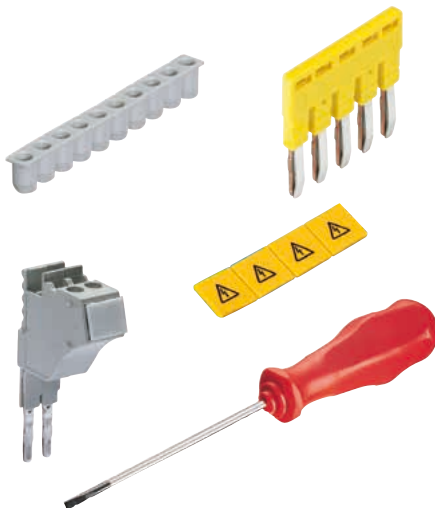

ACCESSORIES	Type	Part No.	Std. Pack	
Cross connector, insulated	2-pole	IVB WKFN 2,5 – 2	Z7.280.6227.0	10
	3-pole	IVB WKFN 2,5 – 3	Z7.280.6327.0	10
	4-pole	IVB WKFN 2,5 – 4	Z7.280.6427.0	10
	5-pole	IVB WKFN 2,5 – 5	Z7.280.6527.0	10
	6-pole	IVB WKFN 2,5 – 6	Z7.280.6627.0	10
	7-pole	IVB WKFN 2,5 – 7	Z7.280.6727.0	20
	8-pole	IVB WKFN 2,5 – 8	Z7.280.6827.0	20
	9-pole	IVB WKFN 2,5 – 9	Z7.280.6927.0	20
	10-pole	IVB WKFN 2,5 – 10	Z7.280.7027.0	20
	20-pole	IVB WKFN 2,5 – 20	Z7.280.8027.0	20
Wire entry guide	0.13 – 0.2 mm <sup>2</sup>	LELN 2,5/1 WEISS	05.564.3755.0	100
	0.25 – 0.5 mm <sup>2</sup>	LELN 2,5/2 GRAU	05.564.3855.0	100
	0.75 – 1.0 mm <sup>2</sup>	LELN 2,5/3 SCHWARZ	05.564.3955.0	100
Cover with warning symbol over 4 blocks	yellow	ADFN 2,5/4 GELB	04.343.8353.8	10
Test adapter, modular		PS WKCF	Z1.299.9753.0	10
Test plug		ST 2/2,3	Z5.553.2921.0	10
Screwdriver, uninsulated		DIN 5264 B 0,6x3,5	06.502.4000.0	5
Screwdriver, uninsulated, MINI		DIN 5264 B 0,6x3,5 M	06.502.5000.0	10

# FUSE BLOCKS WITH TENSION SPRING CONNECTION

## WKFN 4 TKG WITH THSI 5 X 20

- Disconnect block with tension spring connection for mounting on TS 35
- Nominal cross section 4 mm<sup>2</sup>

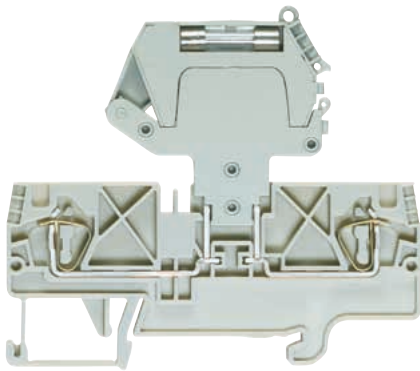

Description	Type	Part No.	Std. Pack
Disconnect block	gray WKFN 4 TKG/35	56.704.4055.0	100
Fuse disconnect lever	THSI 5x20	Z1.298.1053.0	10
Fuse disconnect lever with LED 12–24 V <sup>2)</sup>	THSI 5x20 LED24	Z1.298.1153.0	10
Fuse disconnect lever with LED 24–60 V <sup>2)</sup>	THSI 5x20 LED60	Z1.298.1253.0	10
Fuse disconnect lever with GL 110–250 V <sup>2)</sup>	THSI 5x20 GL250	Z1.298.1353.0	10

GENERAL DATA			
Width / length / height, incl. TS 7.5	6 mm / 82 mm / 38 mm		
Wire strip length	11 mm		
Approvals			
TECHNICAL DATA			
	IEC	UL	CSA
	EN 60 947-7-3		
Cross section fine-stranded	0.13–4 mm <sup>2</sup>		
Cross section solid/stranded	0.13–6 mm <sup>2</sup>		
Cross section, AWG		24–10	22–10
Rated current	<sup>1)</sup>	<sup>1)</sup>	10 A <sup>1)</sup>
Rated voltage	500 V <sup>2)</sup>	600 V <sup>2)</sup>	300 V <sup>2)</sup>
Rated impulse voltage	8 kV		
Pollution degree	3		

Accessories	Type	Part No.	Std. Pack
End plate	gray APFN 4 D2/2	07.312.9055.0	10
Partition	gray TWFN 4 D2/2	07.312.9155.0	10

## WKFN 4 TKG WITH THSI 6,3 X 32

- Disconnect block with tension spring connection for mounting on TS 35
- Nominal cross section 4 mm<sup>2</sup>

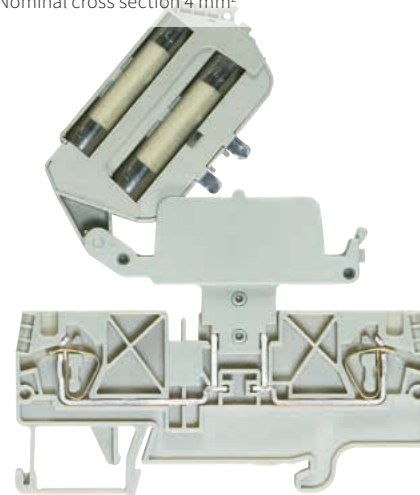

Description	Type	Part No.	Std. Pack
Disconnect block	gray WKFN 4 TKG/35	56.704.4055.0	100
Fuse disconnect lever	THSI 6,3x32	Z1.298.1653.0	10
Fuse disconnect lever with LED 12–24 V <sup>2)</sup>	THSI 6,3x32 LED24	Z1.298.1753.0	10
Fuse disconnect lever with LED 24–60 V <sup>2)</sup>	THSI 6,3x32 LED60	Z1.298.1853.0	10
Fuse disconnect lever with GL 110–250 V <sup>2)</sup>	THSI 6,3x32 GL250	Z1.298.1953.0	10
Fuse disconnect lever with GL 500 V <sup>2)</sup>	THSI 6,3x32 GL500	Z1.298.2053.0	10

GENERAL DATA			
Width / length / height, incl. TS 7.5	6 mm / 82 mm / 38 mm		
Wire strip length	11 mm		
Approvals			
TECHNICAL DATA			
	IEC	UL	CSA
	EN 60 947-7-3		
Cross section fine-stranded	0.13–4 mm <sup>2</sup>		
Cross section solid/stranded	0.13–6 mm <sup>2</sup>		
Cross section, AWG		24–10	22–10
Rated current	<sup>1)</sup>	<sup>1)</sup>	10 A <sup>1)</sup>
Rated voltage	500 V <sup>2)</sup>	600 V <sup>2)</sup>	300 V <sup>2)</sup>
Rated impulse voltage	8 kV		
Pollution degree	3		

Accessories	Type	Part No.	Std. Pack
End plate	gray APFN 4 D2/2	07.312.9055.0	10
Intermediate plate, 4 mm	gray ZP/WKFN 4 TKG	07.313.1655.0	10
Partition	gray TWFN 4 D2/2	07.312.9155.0	10

# INFO AND ACCESSORIES FOR FASIS WKFN 4 TKG WITH THSI...

<sup>1)</sup> The current is determined by the inserted fuse.

<sup>2)</sup> The voltage range is determined by the built-in LED display.

Depending on the application and the installation method, the circumstances for increased temperature must be checked in the closed fuse holders.

Higher ambient temperatures are an additional load for the fuse inserts. Therefore, the reduction of the rated current must be considered accordingly in these applications.

Indicator (24 V): LED, red  
current consumption: 10,3 mA

Indicator (220 V): LED, red  
current consumption: 0,3 mA

When selecting G fuse inserts, make sure that the specified maximum power is not exceeded.  
Maximum power loss at 23°C ambient temperature (according to DIN EN 60947-7-3)

Type	Rated voltage	Overload protection		Exclusive short-circuit protection	
		Single arrangement	Group arrangement	Single arrangement	Group arrangement
THSI 5x20	250V	1.6W	1.6W	4.0W	2.5W
THSI 6,3x32	500V	2.5W	1.6W	4.0W	2.5W

Accessories	Type	Part No.	Std. Pack	
Cross connector, insulated for WKFN 4 TKG with THSi 5x20	2-pole	IVB WKF 4-2	Z7.261.1227.0	10
	3-pole	IVB WKF 4-3	Z7.261.1327.0	10
	4-pole	IVB WKF 4-4	Z7.261.1427.0	10
	5-pole	IVB WKF 4-5	Z7.261.1527.0	10
	6-pole	IVB WKF 4-6	Z7.261.1627.0	10
	7-pole	IVB WKF 4-7	Z7.261.1727.0	20
	8-pole	IVB WKF 4-8	Z7.261.1827.0	20
	9-pole	IVB WKF 4-9	Z7.261.1927.0	20
	10-pole	IVB WKF 4-10	Z7.261.2027.0	20
	Wire entry guide	0.13–0.2 mm <sup>2</sup>	LEL 4/1 WEISS	05.561.8553.0
0.25–0.5 mm <sup>2</sup>		LEL 4/2 GRAU	05.561.8653.0	100
0.75–1.0 mm <sup>2</sup>		LEL 4/3 SCHWARZ	05.561.8753.0	100
Cover with warning symbol over 4 blocks	yellow	ADF 4/4 GELB	04.343.6153.8	10
Test adapter, modular		ST 2/2,3	Z5.553.2921.0	10
Screwdriver, uninsulated		DIN 5264 B 0,6x3,5	06.502.4000.0	5
Screwdriver, uninsulated, MINI		DIN 5264 B 0,6x3,5 M	06.502.5000.0	10

For WKFN 4 TKG with THSi 6.3x32 and intermediate plate cross connector IVB WKF 2,5-x must be used.

## WKFN 4 TKG WITH SIST

- Disconnect block with tension spring connection for mounting on TS 35
- Nominal cross section 4 mm<sup>2</sup>

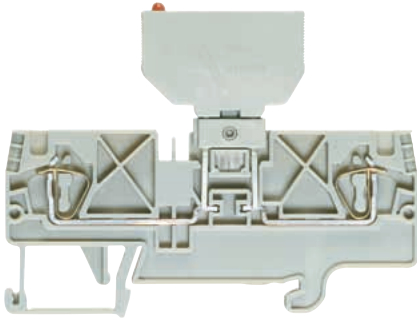

Description	Type	Part No.	Std. Pack
Disconnect block	gray WKFN 4 TKG/35	56.704.4055.0	100
Fuse holder for fuse 5 x 20	Si ST	Z1.299.4055.0	10
Fuse holder with indicator (24 V) <sup>2)</sup>	Si ST LED	Z1.299.4155.0	10
Fuse holder with indicator (220 V) <sup>2)</sup>	Si ST GL	Z1.299.4255.0	10

GENERAL DATA			
Width / length / height, incl. TS 7.5	6 mm / 82 mm / 38 mm		
Wire strip length	11 mm		
Approvals			

TECHNICAL DATA	IEC	UL	CSA
	EN 60 947-7-3		
Cross section fine-stranded	0.13 – 4 mm <sup>2</sup>		
Cross section solid/stranded	0.13 – 6 mm <sup>2</sup>		
Cross section, AWG		24 – 10	22 – 10
Rated current	1)	1)	10 A <sup>1)</sup>
Rated voltage	500 V <sup>2)</sup>	600 V <sup>2)</sup>	300 V <sup>2)</sup>
Rated impulse voltage	8 kV		
Pollution degree	3		

ACCESSORIES	Type	Part No.	Std. Pack
End plate	gray APFN 4 D2/2	07.312.9055.0	10
Partition	gray TWFN 4 D2/2	07.312.9155.0	10

## WKFN 4 TKG WITH DIST

- Disconnect block with tension spring connection for mounting on TS 35
- Nominal cross section 4 mm<sup>2</sup>

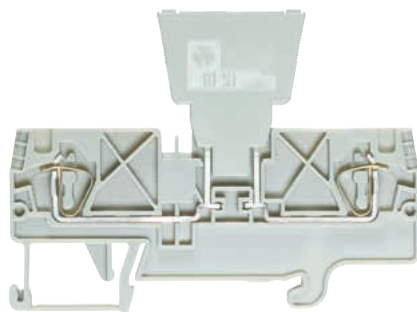

Description	Type	Part No.	Std. Pack
Disconnect block	gray WKFN 4 TKG/35	56.704.4055.0	100
Diode plug – empty	J <sub>max</sub> = 10 A <sup>1)</sup> DIST ...	Z1.299.3055.0	10
Diode plug – diode	J <sub>max</sub> = 1 A <sup>1)</sup> DIST-1 N 4007-1 <sup>3)</sup>	Z1.299.3155.0	10
Diode plug – diode	J <sub>max</sub> = 1 A <sup>1)</sup> DIST-1 N 4007-2 <sup>4)</sup>	Z1.299.3355.0	10
Diode plug with jumper	J <sub>max</sub> = 10 A <sup>1)</sup> DIST-D	Z1.299.3255.0	10

GENERAL DATA			
Width / length / height, incl. TS 7.5	6 mm / 82 mm / 38 mm		
Wire strip length	11 mm		
Approvals			

TECHNICAL DATA	IEC	UL	CSA
	EN 60 947-7-3		
Cross section fine-stranded	0.13 – 4 mm <sup>2</sup>		
Cross section solid/stranded	0.13 – 6 mm <sup>2</sup>		
Cross section, AWG		24 – 10	22 – 10
Rated current	1)	1)	10 A <sup>1)</sup>
Rated voltage	500 V <sup>2)</sup>	600 V <sup>2)</sup>	300 V <sup>2)</sup>
Rated impulse voltage	8 kV		
Pollution degree	3		

ACCESSORIES	Type	Part No.	Std. Pack
End plate	gray APFN 4 D2/2	07.312.9055.0	10
Partition	gray TWFN 4 D2/2	07.312.9155.0	10

# INFO AND ACCESSORIES FOR FASIS WKFN 4 TKG WITH SIST AND DIST

<sup>1)</sup> The current is determined by the inserted fuse.

<sup>2)</sup> The voltage range is determined by the built-in LED display.

Depending on the application and the installation method, the circumstances for increased temperature must be checked in the closed fuse holders.

Higher ambient temperatures are an additional load for the fuse inserts. Therefore, the reduction of the rated current must be considered accordingly in these applications.

Indicator (24 V): LED, red  
current consumption: 10.3 mA

Indicator (220 V): LED, red  
current consumption: 0.3 mA

<sup>3)/4)</sup> Periodic peak voltage 1000 V  
Direction of the diode: Anode Cathode<sup>3)</sup>  
Cathode Anode<sup>4)</sup>

When selecting G fuse inserts, make sure that the specified maximum power is not exceeded.  
Maximum power loss at 23° C ambient temperature (according to DIN EN 60947-7-3)

Type	Rated voltage	Overload protection		Exclusive short-circuit protection	
		Single arrangement	Group arrangement	Single arrangement	Group arrangement
SIST	250 V	1.6 W	1.6 W	2.5 W	1.6 W

ACCESSORIES	Type	Part No.	Std. Pack	
Cross connector, insulated	2-pole	IVB WKF 4-2	Z7.261.1227.0	10
	3-pole	IVB WKF 4-3	Z7.261.1327.0	10
	4-pole	IVB WKF 4-4	Z7.261.1427.0	10
	5-pole	IVB WKF 4-5	Z7.261.1527.0	10
	6-pole	IVB WKF 4-6	Z7.261.1627.0	10
	7-pole	IVB WKF 4-7	Z7.261.1727.0	20
	8-pole	IVB WKF 4-8	Z7.261.1827.0	20
	9-pole	IVB WKF 4-9	Z7.261.1927.0	20
	10-pole	IVB WKF 4-10	Z7.261.2027.0	20
	Wire entry guide	0.13 – 0.2 mm <sup>2</sup>	LEL 4/1 WEISS	05.561.8553.0
0.25 – 0.5 mm <sup>2</sup>		LEL 4/2 GRAU	05.561.8653.0	100
0.75 – 1.0 mm <sup>2</sup>		LEL 4/3 SCHWARZ	05.561.8753.0	100
Cover with warning symbol over 4 blocks	yellow	ADF 4/4 GELB	04.343.6153.8	10
Test adapter, modular		ST 2/2,3	Z5.553.2921.0	10
Screwdriver, uninsulated		DIN 5264 B 0,6x3,5	06.502.4000.0	5
Screwdriver, uninsulated, MINI		DIN 5264 B 0,6x3,5 M	06.502.5000.0	10

# FUSE BLOCKS WITH TENSION SPRING CONNECTION

## WKFN 4 FSI

- Fuse block for automobile fuses for mounting on TS 35
- Nominal cross section 4 mm<sup>2</sup>

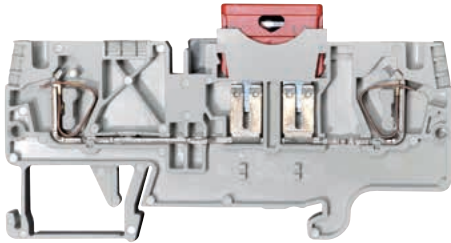

Description	Type	Part No.	Std. Pack
Fuse block	gray WKFN 4 FSI	56.704.4155.0	100

GENERAL DATA	
Width / length / height, incl. TS 7.5	6 mm / 82 mm / 39 mm
Wire strip length	12 mm
Approvals	

TECHNICAL DATA	IEC	UL	CSA
Cross section fine-stranded	0.13 – 4 mm <sup>2</sup>		
Cross section solid/stranded	0.13 – 6 mm <sup>2</sup>		
Cross section, AWG			
Rated current	*		
Rated voltage	800 V		
Rated impulse voltage	8 kV		
Pollution degree	3		
<b>Note</b>	* Observe the derating curve, available in our e-catalog at <a href="https://eshop.wieland-electric.com">https://eshop.wieland-electric.com</a>		

ACCESSORIES	Type	Part No.	Std. Pack
End plate	gray APFN 4 D2/2	07.312.9055.0	10
Partition, 4 mm for TCP	gray ZP/WKFN 4 TKG	07.313.1655.0	10
Partition	gray TWFN 4 D2/2	07.312.9155.0	10

## WKFN 4 FSI

- Fuse block with indicator for mounting on TS 35
- Nominal cross section 4 mm<sup>2</sup>

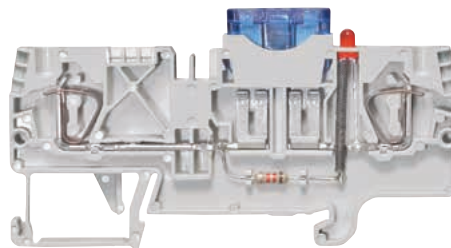

Description	Type	Part No.	Std. Pack
Fuse block	gray WKFN 4 FSI LED12	56.704.4255.0	100
Fuse block	gray WKFN 4 FSI LED24	56.704.5355.0	100

GENERAL DATA	
Width / length / height, incl. TS 7.5	6 mm / 82 mm / 39 mm
Wire strip length	12 mm
Approvals	

TECHNICAL DATA	IEC	UL	CSA
Cross section fine-stranded	0.13 – 4 mm <sup>2</sup>		
Cross section solid/stranded	0.13 – 6 mm <sup>2</sup>		
Cross section, AWG			
Rated current	*		
Rated voltage	800 V		
Rated impulse voltage	8 kV		
Pollution degree	3		
<b>Note</b>	* Observe the derating curve, available in our e-catalog at <a href="https://eshop.wieland-electric.com">https://eshop.wieland-electric.com</a>		

ACCESSORIES	Type	Part No.	Std. Pack
End plate	gray APFN 4 D2/2	07.312.9055.0	10
Partition, 4 mm for TCP	gray ZP/WKFN 4 TKG	07.313.1655.0	10
Partition	gray TWFN 4 D2/2	07.312.9155.0	10

## AUTOMOTIVE FUSES

The WKFN 4 FSI .. type fuse blocks take blade-type fuses according to ISO 8820 (DIN 72581-3).

Automotive fuses are not offered for sale by Wieland Electric!

We recommend the following:



Description	Color	
<b>Blade-type automobile fuse, DC 32 V</b>	black	1 A
Electrotechnical specialized trade	gray	2 A
Motor vehicle accessory market	violet	3 A
	pink	4 A
	beige	5 A
	brown	7.5 A
	red	10 A
	blue	15 A
	yellow	20 A

<b>Thermal circuit breaker, DC 32 V</b>	5 A
ETA*, type 1610-21 or	6 A
ETA*, type 1610-H2 with manual release	10 A
	15 A
	20 A

<b>Thermal circuit breaker, AC 250 V; DC 65 V</b>	0.1 A
ETA*, type 1180 ..	0.2 A
	0.5 A
	1 A
	2 A
	3 A
	4 A
	6 A
	8 A
	10 A

\* E-T-A Elektrotechnische Apparate GmbH, [www.e-t-a.de](http://www.e-t-a.de)



# SUPPLY TERMINAL



## WKF 16/35 PV/WKFN

- Supply terminal for mounting on TS 35
- Nominal cross section 16 mm<sup>2</sup>
- Ex e I/II II 2GD IM2  
Follow the EX installation instructions on page 174

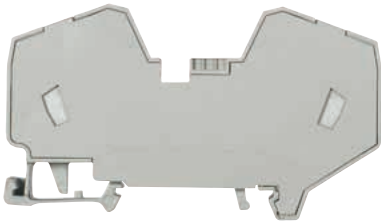

Description	Type	Part No.	Std. Pack	
Supply terminal	gray	WKF 16/35 PV/WKFN	56.716.0353.0	20

GENERAL DATA				
Width / length / height, incl. TS 7.5	12 mm / 82 mm / 48 mm			
Wire strip length	15 mm			
Approvals			KEMA 01 ATEX 2087 U	

TECHNICAL DATA	IEC	UL	CSA	
	EN 60 947-7-3			EN 60 079-0/-7
Cross section fine-stranded	4 – 16 mm <sup>2</sup>			
Cross section solid/stranded	4 – 16 mm <sup>2</sup>			
Cross section, AWG		24 – 4	12 – 4	
Rated current	76 A	75 A	78 A	64 A <sup>1)</sup>
Rated voltage	800 V	600 V	600 V	690 V
Rated impulse voltage	8 kV			
Pollution degree	3			

**Note** <sup>1)</sup> Derating curves available on request

ACCESSORIES	Type	Part No.	Std. Pack
Cover with warning symbol over 4 blocks	ADF 16/4 GELB	04.343.6653.8	10
Screwdriver, uninsulated	DIN 5264 B 1,0x5,5	06.502.4200.0	5

Potential distribution				
	one side	both sides	single	double
Jumpering	single	double	single	double
IVB WKF 4...				
I <sub>max</sub>	64	76	76	76
I <sub>Nblock</sub>	32	32	32	32

$$I_{\max} = \sum I_n \leq \sum I_{N \text{ block}}$$

## ACCESSORIES FOR FASIS WKFN 4 FSI...



ACCESSORIES	Type	Part No.	Std. Pack	
Cross connector, insulated, for	2 blocks	IVB WKF 4-2	Z7.261.1227.0	10
	3 blocks	IVB WKF 4-3	Z7.261.1327.0	10
	4 blocks	IVB WKF 4-4	Z7.261.1427.0	10
	5 blocks	IVB WKF 4-5	Z7.261.1527.0	10
	6 blocks	IVB WKF 4-6	Z7.261.1627.0	10
	7 blocks	IVB WKF 4-7	Z7.261.1727.0	20
	8 blocks	IVB WKF 4-8	Z7.261.1827.0	20
	9 blocks	IVB WKF 4-9	Z7.261.1927.0	20
	10 blocks	IVB WKF 4-10	Z7.261.2027.0	20
	Wire entry guide	0.13 – 0.2 mm <sup>2</sup>	LEL 4/1 WEISS	05.561.8553.0
0.25 – 0.5 mm <sup>2</sup>		LEL 4/2 GRAU	05.561.8653.0	100
0.75 – 1.0 mm <sup>2</sup>		LEL 4/1 SCHWARZ	05.561.8753.0	100
Cover with warning symbol over 4 blocks	yellow	ADF 4/4 GELB	04.343.6153.8	10
Screwdriver, uninsulated		DIN 5264 B 0,6x3,5	06.502.4000.0	5
Screwdriver, uninsulated, MINI		DIN 5264 B 0,6x3,5 M	06.502.5000.0	10



# FASIS CON

## DIN RAIL TERMINAL BLOCKS WITH PLUG-IN CONNECTION

### THE SYSTEM

- Rated current up to 32 A
- Connection cross-section 4 mm<sup>2</sup>
- Width 5 mm

### THE TERMINALS

Modular DIN rail mount terminals for universal use with pluggable connectors, all with tension spring connection technology.

In addition to the pluggable connection, a tension spring connection also is available to use the block as a standard feed-through terminal.

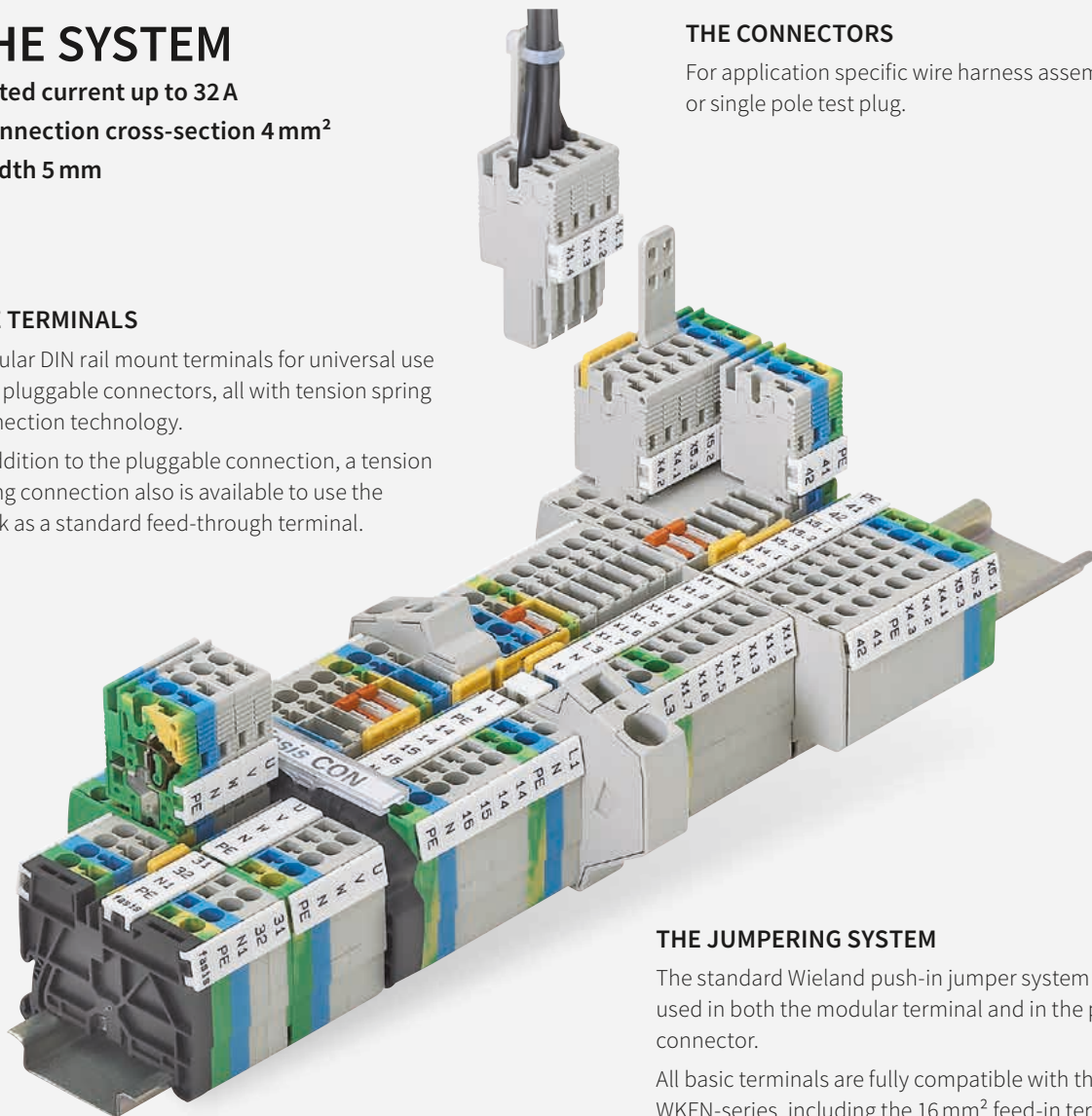

### THE CONNECTORS

For application specific wire harness assemblies, or single pole test plug.

### THE LABELING SYSTEM

All termination points can be clearly labeled using the standard Wieland labeling system.

### INTEGRATED SAFETY

Touch protection of all components, even when not connected, IP 20 when connected.

All plug connectors have a built-in latching mechanism and coding option – no further accessories required.

### THE JUMPERING SYSTEM

The standard Wieland push-in jumper system can be used in both the modular terminal and in the plug-in connector.

All basic terminals are fully compatible with the fasis WKFN-series, including the 16 mm<sup>2</sup> feed-in terminal.

The modular terminal block's integrated jumper channel maintains a permanent feed-through connection even when the plug is not installed.



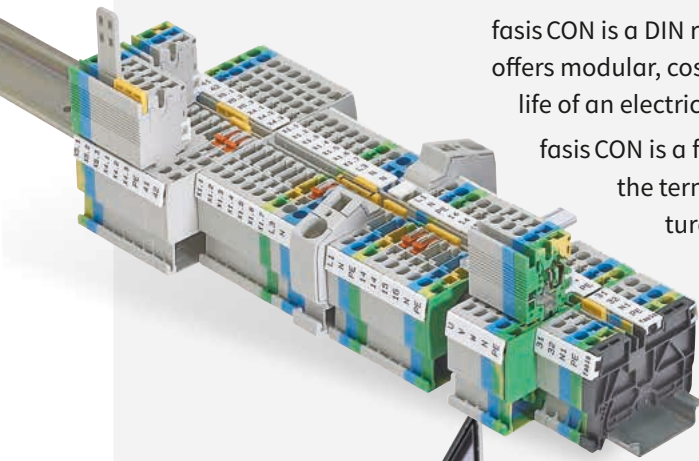

fasis CON is a DIN rail terminal block system with a pluggable outgoing feeder, which offers modular, cost-saving solutions with advantages in every phase of the service life of an electrical system.

fasis CON is a fully compatible part of the established fasis WKFN system. Both the terminal and the plug connector possess the high-performance features of fasis WKFN.

fasis CON consists of feed-through and ground DIN rail terminal blocks with a wide variety of both wiring termination points and sockets for the fasis CON pluggable connectors.

fasis CON is a cost-effective, high-performance and pluggable system solution.

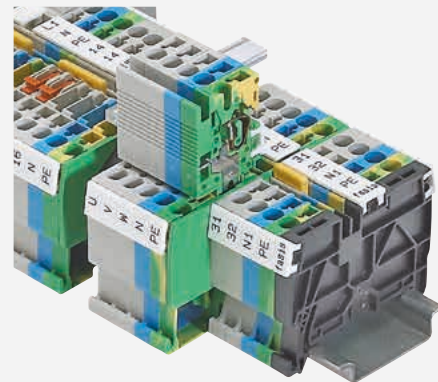

### COST-EFFECTIVE

- Cost-optimized installation and maintenance times
- Small numbers of components
- Can be assembled individually
- Pre-assembled modules

### HIGH-PERFORMANCE

- Range of terminals up to 4 mm<sup>2</sup>
- Rated current up to 32 A\*
- Rated voltage 500 V
- Total width only 5 mm

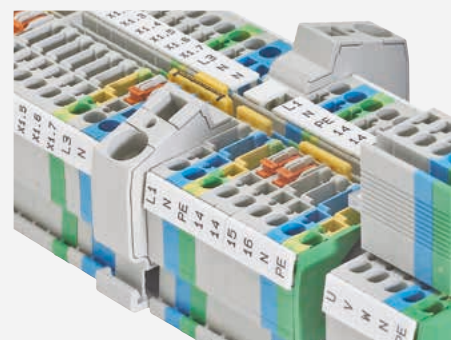
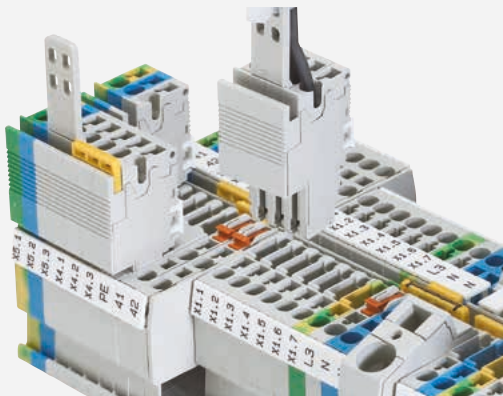

### PLUGGABLE

- Complex systems can be brought on-line quickly and cost-effectively with pluggable technology
- Functional units can be tested easily
- Field components can be more quickly replaced when faults occur
- Systems can be expanded with pluggable technology

### COMPLETE SYSTEM

- Uniform accessories
- Coded to prevent mismatching
- All components can be jumpered
- Comprehensive and clear labeling
- Can be combined with fasis WKFN

\* Observe the derating curve, available in our online-catalog at <https://eshop.wieland-electric.com>

# DIN RAIL TERMINAL BLOCKS WITH PLUG-IN CONNECTION

## WKFN 2,5 F/P/F

- DIN rail terminal blocks with plug-in connection for mounting on TS 35
- Nominal cross section 2.5 mm<sup>2</sup>

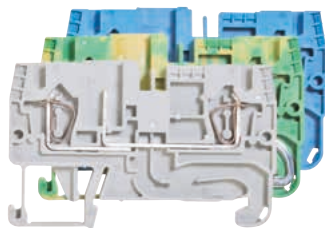

Description	Type	Part No.	Std. Pack	
Feed-through block F/P/F	gray	WKFN 2,5 F/P/F	56.703.2355.0	100
Feed-through block F/P/F	blue	WKFN 2,5 F/P/F	56.703.2355.6	100
Ground block	green/yellow	WKFN 2,5 F/P/F-SL	56.703.2455.0	100

GENERAL DATA			
Width / length / height, incl. TS 7.5	5 mm / 60 mm / 39 mm		
Wire strip length	11 mm		
Approvals			
TECHNICAL DATA			
	IEC	UL	CSA
	EN 60947-7-1/-2		
Cross section fine-stranded	0.13 – 4 mm <sup>2</sup>		
Cross section solid/stranded	0.13 – 4 mm <sup>2</sup>		
Cross section, AWG		24 – 12	24 – 12
Rated current	32 A*	20 A	20 A
Rated voltage	500 V	500 V	500 V
Rated impulse voltage	8 kV		
Pollution degree	3		
<b>Note</b>	* Observe the derating curve, available in our e-catalog at <a href="https://eshop.wieland-electric.com">https://eshop.wieland-electric.com</a>		

ACCESSORIES	Type	Part No.	Std. Pack	
End plate	gray	APFN 2,5 D1/2	07.312.6955.0	10
End plate	blue	APFN 2,5 D1/2 BLAU	07.312.6955.6	10
Partition	gray	TWFN 2,5 D1/2	07.312.7055.0	10

## WKFN 2,5 2P/2F

- DIN rail terminal blocks with plug-in connection for mounting on TS 35
- Nominal cross section 2.5 mm<sup>2</sup>

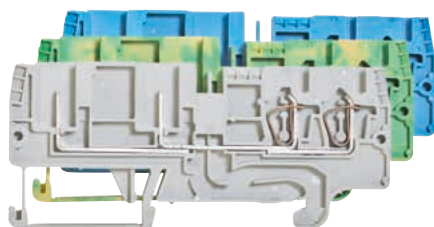

Description	Type	Part No.	Std. Pack	
Feed-through block 2P/2F	gray	WKFN 2,5 2P/2F	56.703.2155.0	100
Feed-through block 2P/2F	blue	WKFN 2,5 2P/2F	56.703.2155.6	100
Ground block	green/yellow	WKFN 2,5 2P/2F-SL	56.703.2255.0	100

GENERAL DATA			
Width / length / height, incl. TS 7.5	5 mm / 85 mm / 39 mm		
Wire strip length	11 mm		
Approvals			
TECHNICAL DATA			
	IEC	UL	CSA
	EN 60947-7-1/-2		
Cross section fine-stranded	0.13 – 4 mm <sup>2</sup>		
Cross section solid/stranded	0.13 – 4 mm <sup>2</sup>		
Cross section, AWG		24 – 12	24 – 12
Rated current	32 A*	20 A	20 A
Rated voltage	500 V	500 V	500 V
Rated impulse voltage	8 kV		
Pollution degree	3		
<b>Note</b>	* Observe the derating curve, available in our e-catalog at <a href="https://eshop.wieland-electric.com">https://eshop.wieland-electric.com</a>		

ACCESSORIES	Type	Part No.	Std. Pack	
End plate	gray	APFN 2,5 TKM D2/2	07.313.0055.0	10
Partition	gray	TWFN 2,5 TKM D2/2	07.313.0155.0	10

## WKFN 2,5 E/././..

- Multi-tier blocks with plug-in connection for mounting on TS 35
- Nominal cross section 2.5 mm<sup>2</sup>

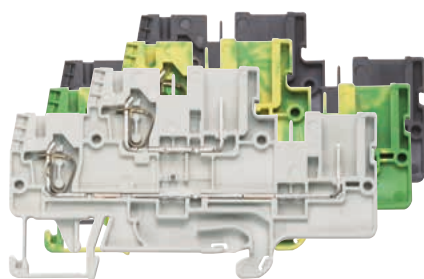

Description	Type	Part No.	Std. Pack	
Multi-tier block E/F/P	gray	WKFN 2,5 E/F/P	56.703.3455.0	100
Multi-tier block, vertically connected	black	WKFN 2,5 E/VB/F/P	56.703.3555.1	100
Multi-tier ground block	green/yellow	WKFN 2,5 E/F/P/SL	56.703.3655.0	100

GENERAL DATA			
Width / length / height, incl. TS 7.5	5 mm / 82 mm / 49 mm		
Wire strip length	11 mm		
Approvals			
TECHNICAL DATA			
	IEC	UL	CSA
	EN 60947-7-1/-2		
Cross section fine-stranded	0.13 – 4 mm <sup>2</sup>		
Cross section solid/stranded	0.13 – 4 mm <sup>2</sup>		
Cross section, AWG		24 – 12	24 – 12
Rated current	22 A*	20 A	20 A
Rated voltage	500 V	500 V	500 V
Rated impulse voltage	8 kV		
Pollution degree	3		
<b>Note</b>	* Observe the derating curve, available in our e-catalog at <a href="https://eshop.wieland-electric.com">https://eshop.wieland-electric.com</a>		

ACCESSORIES	Type	Part No.	Std. Pack	
End plate	gray	APFN 2,5 E	07.312.7355.0	10
Partition	gray	TWFN 2,5 E	07.312.7455.0	10



# CONNECTORS



## WBF 2,5/..../.

- Connectors for DIN rail terminal blocks with plug-in connection

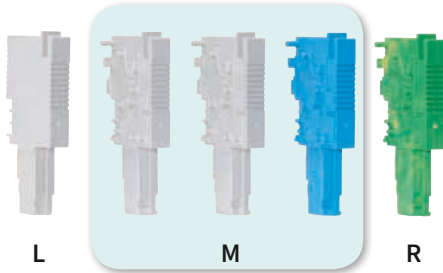

Description	Type	Part No.	Std. Pack
<b>Connectors LEFT</b>			
	gray WBF 2,5 1/L/GR	Z1.110.8955.0	50
	blue WBF 2,5 1/L/BL	Z1.110.8955.6	50
	green/yellow WBF 2,5 1/L/SL	Z1.110.8955.7	50
<b>Connectors MIDDLE</b>			
	gray WBF 2,5 1/M/GR	Z1.110.8855.0	50
	blue WBF 2,5 1/M/BL	Z1.110.8855.6	50
	green/yellow WBF 2,5 1/M/SL	Z1.110.8855.7	50
<b>Connectors RIGHT</b>			
	gray WBF 2,5 1/R/GR	Z1.110.9055.0	50
	blue WBF 2,5 1/R/BL	Z1.110.9055.6	50
	green/yellow WBF 2,5 1/R/SL	Z1.110.9055.7	50
<b>Connectors preassembled, gray</b>			
1-pole	WBF 2,5-1	59.903.0155.0	50
2-pole	WBF 2,5-2	59.903.0255.0	50
3-pole	WBF 2,5-3	59.903.0355.0	50
4-pole	WBF 2,5-4	59.903.0455.0	50
5-pole	WBF 2,5-5	59.903.0555.0	50
6-pole	WBF 2,5-6	59.903.0655.0	25
7-pole	WBF 2,5-7	59.903.0755.0	25
8-pole	WBF 2,5-8	59.903.0855.0	25
9-pole	WBF 2,5-9	59.903.0955.0	25
10-pole	WBF 2,5-10	59.903.1055.0	25

<b>GENERAL DATA</b>				
Width / length / height, incl. TS 7.5	5 mm			
Wire strip length	11 mm			
Approvals				
<b>TECHNICAL DATA</b>		<b>IEC</b>	<b>UL</b>	<b>CSA</b>
		EN 60947-7-1/-2		
Cross section fine-stranded	0.13 – 4 mm <sup>2</sup>			
Cross section solid/stranded	0.13 – 4 mm <sup>2</sup>			
Cross section, AWG			24 – 12	24 – 12
Rated current	32 A*		20 A	20 A
Rated voltage	500 V		500 V	500 V
Rated impulse voltage	8 kV			
Pollution degree	3			

**Note** \* Observe the derating curve, available in our e-catalog at <https://eshop.wieland-electric.com>

ACCESSORIES	Type	Part No.	Std. Pack
Strain relief	Z-WBF	05.567.9155.0	10
Screwdriver, uninsulated	DIN 5264 B 0,6x3,5	06.502.4000.0	10
Screwdriver, MINI	DIN 5264 B 0,6x3,5 M	06.502.5000.0	10

## ACCESSORIES FOR FASIS WKFN 2,5...



ACCESSORIES	Type	Part No.	Std. Pack
Cross connector, insulated, for	2 blocks IVB WKF 2,5-2	Z7.280.6227.0	10
	3 blocks IVB WKF 2,5-3	Z7.280.6327.0	10
	4 blocks IVB WKF 2,5-4	Z7.280.6427.0	10
	5 blocks IVB WKF 2,5-5	Z7.280.6527.0	10
	6 blocks IVB WKF 2,5-6	Z7.280.6627.0	10
	7 blocks IVB WKF 2,5-7	Z7.280.6727.0	20
	8 blocks IVB WKF 2,5-8	Z7.280.6827.0	20
	9 blocks IVB WKF 2,5-9	Z7.280.6927.0	20
	10 blocks IVB WKF 2,5-10	Z7.280.7027.0	20
	20 blocks IVB WKF 2,5-20	Z7.280.8027.0	20
Wire entry guide	0.13 – 0.2 mm <sup>2</sup> LELN 2,5/1 WEISS	05.564.3755.0	100
	0.25 – 0.5 mm <sup>2</sup> LELN 2,5/1 GRAU	05.564.3855.0	100
	0.75 – 1.0 mm <sup>2</sup> LELN 2,5/1 SCHWARZ	05.564.3955.0	100
Cover with warning symbol over 4 blocks	yellow ADFN 2,5/4 GELB	04.343.8353.8	10
Test adapter, modular	PS WKC/F	Z1.299.9753.0	10
Screwdriver, uninsulated	DIN 5264 B 0,6x3,5	06.502.4000.0	5
Screwdriver, uninsulated, MINI	DIN 5264 B 0,6x3,5 M	06.502.5000.0	10



# DIN RAIL TERMINAL BLOCKS WITH TENSION SPRING AND PLUGGABLE CONNECTIONS

## WKF 2,5 D2/8113/35

- Duo feed-through block for mounting on TS 35
- Nominal cross section 2.5 mm<sup>2</sup>

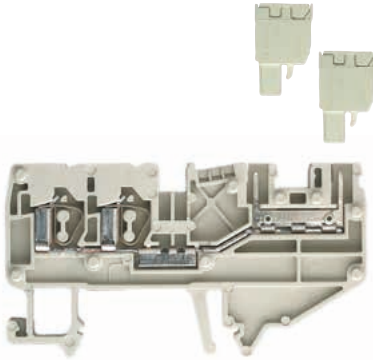

Description	Type	Part No.	Std. Pack	
Duo feed-through block	gray	WKF 2,5 D2/8113/35	56.703.2053.0	100
Duo feed-through block	blue	WKF 2,5 D2/8113/35 BLAU	56.703.2053.6	100
<b>General data</b>				
Width / length / height, incl. TS 7.5	5 mm / 76 mm / 42 mm			
Wire strip length	11 mm			
Approvals				
<b>TECHNICAL DATA</b>		<b>IEC</b>	<b>UL</b>	<b>CSA</b>
	EN 60947-7-1			
Cross section fine-stranded	0.13 – 2.5 mm <sup>2</sup>			
Cross section solid/stranded	0.13 – 4 mm <sup>2</sup>			
Cross section, AWG		22 – 12	24 – 12	
Rated current	16 A	15 A	15 A	
Rated voltage	250 V	300 V	300 V	
Rated impulse voltage	4 kV			
Pollution degree	3			
<b>ACCESSORIES</b>		<b>Type</b>	<b>Part No.</b>	<b>Std. Pack</b>
End plate	gray	APF 2,5/D2/8113	07.312.4153.0	10
End plate	blue	APF 2,5/D2/8113	07.312.4153.6	10
Wire entry guide	0.13 – 0.2 mm <sup>2</sup>	LEL 2,5/1 WEISS	05.561.6553.0	100
	0.25 – 0.5 mm <sup>2</sup>	LEL 2,5/2 GRAU	05.561.6653.0	100
	0.75 – 1.0 mm <sup>2</sup>	LEL 2,5/3 SCHWARZ	05.561.6753.0	100
Cover with warning symbol over 4 blocks		ADF 2,5/4 GELB	04.343.6053.8	10

## WKF 2,5 D2/8113/SL/35

- Duo-ground block for mounting on TS 35
- Nominal cross section 2.5 mm<sup>2</sup>

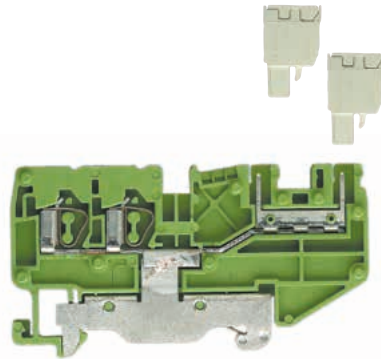

Description	Type	Part No.	Std. Pack	
Duo-ground block	green/yellow	WKF 2,5 D2/8113 SL/35	56.703.9253.0	100
<b>GENERAL DATA</b>				
Width / length / height, incl. TS 7.5	5 mm / 76 mm / 42 mm			
Wire strip length	11 mm			
Approvals				
<b>TECHNICAL DATA</b>		<b>IEC</b>	<b>UL</b>	<b>CSA</b>
	EN 60947-7-1			
Cross section fine-stranded	0.13 – 2.5 mm <sup>2</sup>			
Cross section solid/stranded	0.13 – 4 mm <sup>2</sup>			
Cross section, AWG		22 – 12	24 – 12	
Rated current	16 A			
Rated voltage	250 V	300 V	300 V	
Rated impulse voltage	4 kV			
Pollution degree	3			
<b>ACCESSORIES</b>		<b>Type</b>	<b>Part No.</b>	<b>Std. Pack</b>
End plate	gray	APF 2,5/D2/8113	07.312.4153.0	10
Wire entry guide	0.13 – 0.2 mm <sup>2</sup>	LEL 2,5/1 WEISS	05.561.6553.0	100
	0.25 – 0.5 mm <sup>2</sup>	LEL 2,5/2 GRAU	05.561.6653.0	100
	0.75 – 1.0 mm <sup>2</sup>	LEL 2,5/3 SCHWARZ	05.561.6753.0	100
Cover with warning symbol over 4 blocks		ADF 2,5/4 GELB	04.343.6053.8	10

## WKF 1,5 E/8113/35

- Multi-tier block for mounting on TS 35
- Nominal cross section 1.5 mm<sup>2</sup>

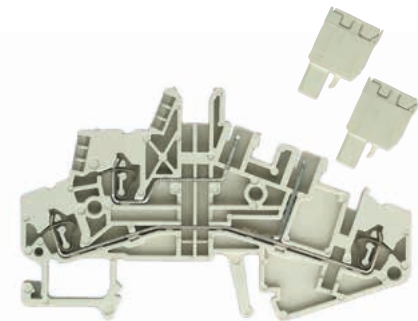

Description	Type	Part No.	Std. Pack	
Multi-tier block	gray	WKF 1,5 E/8113/35	56.702.2053.0	100
<b>GENERAL DATA</b>				
Width / length / height, incl. TS 7.5	5 mm / 83 mm / 51 mm			
Wire strip length	8 mm			
Approvals				
<b>TECHNICAL DATA</b>		<b>IEC</b>	<b>UL</b>	<b>CSA</b>
	EN 60947-7-1			
Cross section fine-stranded	0.13 – 1.5 mm <sup>2</sup>			
Cross section solid/stranded	0.13 – 2.5 mm <sup>2</sup>			
Cross section, AWG		22 – 12	24 – 12	
Rated current	16 A			
Rated voltage	250 V			
Rated impulse voltage	4 kV			
Pollution degree	3			
<b>ACCESSORIES</b>		<b>Type</b>	<b>Part No.</b>	<b>Std. Pack</b>
End plate	gray	APF 1,5/E/8113	07.312.4753.0	10
Wire entry guide	0.13 – 0.2 mm <sup>2</sup>	LEL 1,5/1 WEISS	05.562.2453.0	100
	0.25 – 0.5 mm <sup>2</sup>	LEL 1,5/2 GRAU	05.562.2553.0	100
	0.75 – 1.0 mm <sup>2</sup>	LEL 1,5/3 SCHWARZ	05.562.2653.0	100
Cover with warning symbol over 4 blocks		ADF 1,5/4 GELB	04.343.8353.8	10

## WKF 1,5 E/35

- Multi-tier block for mounting on TS 35
- Nominal cross section 1.5 mm<sup>2</sup>



Description	Type	Part No.	Std. Pack
Multi-tier block	gray WKF 1,5 E/35	56.702.7053.0	100

### GENERAL DATA

Width / length / height, incl. TS 7.5	5 mm / 83 mm / 51 mm
Wire strip length	8 mm
Approvals	

### TECHNICAL DATA

IEC	UL	CSA
EN 60947-7-1		
Cross section fine-stranded	0.13 – 1.5 mm <sup>2</sup>	
Cross section solid/stranded	0.13 – 2.5 mm <sup>2</sup>	
Cross section, AWG	30 – 14	30 – 14
Rated current	17,5 A	15 A
Rated voltage	400 V	300 V
Rated impulse voltage	6 kV	600 V
Pollution degree	3	

### ACCESSORIES

Type	Part No.	Std. Pack
End plate	gray APF 1,5 E	07.312.3553.0
Partition	gray TWF 1,5 E	07.312.3653.0
Wire entry guide	0.13 – 0.2 mm <sup>2</sup> LEL 1,5/1 WEISS	05.562.2453.0
	0.25 – 0.5 mm <sup>2</sup> LEL 1,5/2 GRAU	05.562.2553.0
	0.75 – 1.0 mm <sup>2</sup> LEL 1,5/3 SCHWARZ	05.562.2653.0
Cover with warning symbol over 4 blocks	ADF 1,5/4 GELB	04.343.8353.8

## WIECON PC BOARD CONNECTOR

### TYPE 8113 BFK

- Spring clamp/tension spring system
- 5 mm spacing, nominal cross section 2,5 mm<sup>2</sup>
- Accessories: coding pice 05.561.9153.0
- Rated voltages: VDE 0110/01.89  
250 V/4 kV/3 – Overvoltage category III  
400 V/4 kV/2 – Overvoltage category II  
1000 V/4 kV/1 – Overvoltage category I

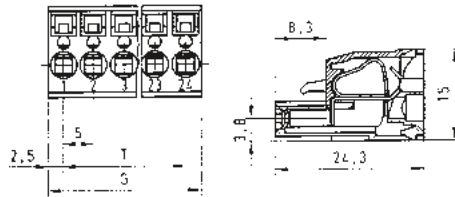

G	T	Pole	Part No.	Part No.	Std. Pack
<b>5 mm spacing</b>					
			<b>unmarked</b>	<b>marked</b>	
10.00	5.00	2	25.920.3253.0	25.920.0253.0	100
15.00	10.00	3	25.920.3353.0	25.920.0353.0	100
20.00	15.00	4	25.920.3453.0	25.920.0453.0	50
25.00	20.00	5	25.920.3553.0	25.920.0553.0	50
30.00	25.00	6	25.920.3653.0	25.920.0653.0	50
35.00	30.00	7	25.920.3753.0	25.920.0753.0	50
40.00	35.00	8	25.920.3853.0	25.920.0853.0	50
45.00	40.00	9	25.920.3953.0	25.920.0953.0	50
50.00	45.00	10	25.920.4053.0	25.920.1053.0	50
55.00	50.00	11	25.920.4153.0	25.920.1153.0	50
60.00	55.00	12	25.920.4253.0	25.920.1253.0	50
65.00	60.00	13	25.920.4353.0	25.920.1353.0	50
70.00	65.00	14	25.920.4453.0	25.920.1453.0	50
75.00	70.00	15	25.920.4553.0	25.920.1553.0	50
80.00	75.00	16	25.920.4653.0	25.920.1653.0	50

17- to 24-pole configurations upon request

### GENERAL DATA

Wire strip length	9 mm
Approvals	

### TECHNICAL DATA

IEC	UL	CSA
EN 60947-7-1		
Cross section fine-stranded	0.13 – 2.5 mm <sup>2</sup>	
Cross section solid/stranded	0.13 – 4 mm <sup>2</sup>	
Cross section, AWG	22 – 12	22 – 12
Rated current	12 A	12 A
Rated voltage	300 V	300 V
Rated impulse voltage		
Pollution degree		

## ACCESSORIES FOR FASIS WKF 2,5 D... AND WKF 1,5 E...

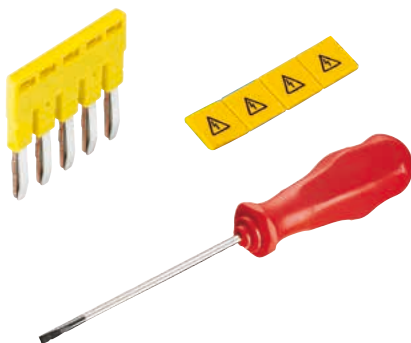

ACCESSORIES	Type	Part No.	Std. Pack
Cross connector, insulated	2-pole IVB WKF 2,5 – 2	Z7.280.6227.0	10
	3-pole IVB WKF 2,5 – 3	Z7.280.6327.0	10
	4-pole IVB WKF 2,5 – 4	Z7.280.6427.0	10
	5-pole IVB WKF 2,5 – 5	Z7.280.6527.0	10
	6-pole IVB WKF 2,5 – 6	Z7.280.6627.0	10
	7-pole IVB WKF 2,5 – 7	Z7.280.6727.0	20
	8-pole IVB WKF 2,5 – 8	Z7.280.6827.0	20
	9-pole IVB WKF 2,5 – 9	Z7.280.6927.0	20
	10-pole IVB WKF 2,5 – 10	Z7.280.7027.0	20
	20-pole IVB WKF 2,5 – 20	Z7.280.8027.0	20
Cover with warning symbol over 4-poles	yellow AD 8113/4 GELB	04.343.6853.8	10
Screwdriver, uninsulated	DIN 5264 B 0,6x3,5	06.502.4000.0	5
Coding strip		05.561.0053.0	100



# INITIATOR AND ACTUATOR BLOCKS WITH TENSION SPRING CONNECTION

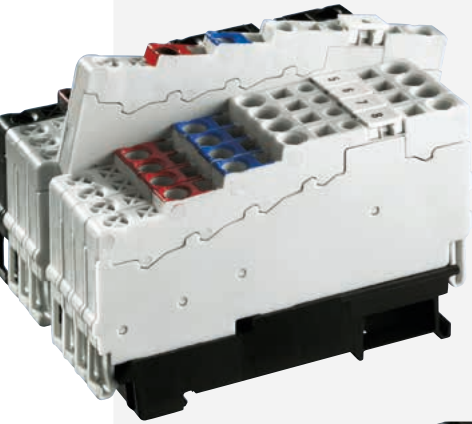

For machine and system control wiring, practice-oriented solutions are preferred that are primarily economical and reliable and thus contribute to the system's operational and functional safety.

fasis KOI was designed to connect the great variety of initiators and actuators to central and remote control systems. The initiator and actuator blocks of type WKF 1,5 KOI have, in particular, been conceived for the requirements in machine and system engineering. They facilitate the wiring task through clearly arranged termination points and an easily accessible and operable tension spring technology.

fasis KOI is a compact and efficient wiring system for connection purposes, potential distribution and transmission of signals from initiators and actuators.

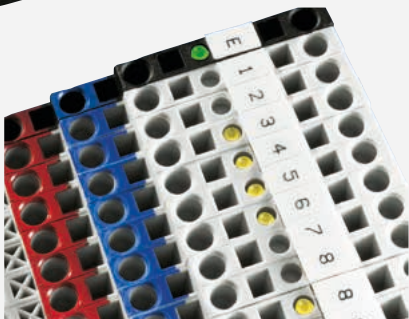

## SYSTEM FEATURES AND BENEFITS

- Control-compatible system solutions through accurate matching of the connection modules' number of poles to the input and output modules of the PLC.
- Flexible connection module mounting options with either snap-on TS 35 DIN rail mount, or direct mounting to a backplane with screws.
- Application-specific individual terminal block as a link between initiators, actuators and the PLC.

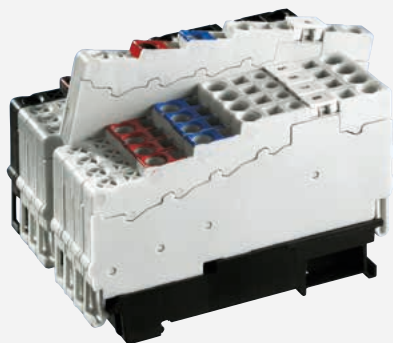

## SERVICE-FRIENDLY OPERATION

- Short maintenance times for modifications of the terminal block assembly by replacing or extending individual blocks without interrupting the power supply of the other initiator and actuator blocks.
- Immediate visual monitoring of the switching states due to integrated light-emitting diodes.
- No maintenance required due to a permanently secure and dynamic tension spring clamp connection system.

## ECONOMICALLY DESIGNED

- Low space requirements due to compact dimensioning of the individual terminal blocks and integration of the potential distribution inside the connection module.
- Efficient installation and start-up of the wiring system by simply fitting the connection module with components, making further accessories unnecessary.
- Reduction of the warehousing costs due to a low variety of parts without having to forego flexibility in the application.

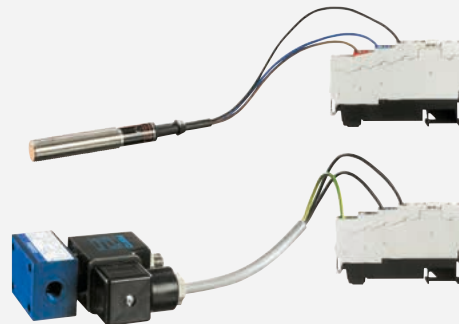

## APPLICATION SPECIFIC OPTIONS

- Power supply to the connection modules through supply blocks, with optional LEDs.
- Potential distribution through connection modules in designs for 9 (1+8) or 18 (2x(1+8)) terminal blocks.
- Initiator blocks, for example for the connection of 3-wire or 4-wire proximity or position switches, with optional LEDs.
- Actuator terminals, for example for the connection of magnetic valves.



**CONNECTION MODULE:  
COLLECT AND DISTRIBUTE POTENTIALS**

- Potential distribution is achieved quickly and safely as soon as the terminal blocks are snapped on.
- Cross connectors for the plus, minus and ground or screen potential are each integrated in the connection modules.
- The system does not require any additional cross connectors.



**WIRE ENTRY GUIDES:  
CONNECT SMALL CROSS SECTIONS SAFELY**

- Wire entry guides prevent the wires from being inserted too deeply (smaller than 1 mm<sup>2</sup>) and enable an easy, professional and quick installation.
- Ensure the connection of solid and fine-stranded wires smaller than 1 mm<sup>2</sup>.
- Also see the accessories for DIN rail terminal blocks starting at page 144



**MARKING SYSTEM:  
ALL CLAMPING POINTS MARKED CLEARLY**

- Marking tags easily readable even with the wires connected.
- Clear assignment of wire to the termination point while wiring.
- Simplified troubleshooting for servicing.
- Customized marking with the wieplot marking system.

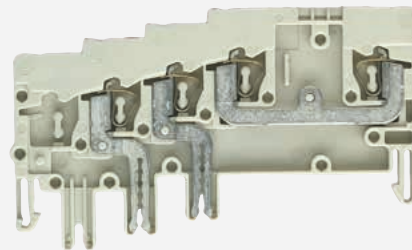

**MATERIALS:  
HIGH-QUALITY MATERIALS**

- Special alloys enable low feed-through resistance and provide a gas-tight contact area:
  - clamping spring: stainless CrNi steel
  - current-carrying bar: tin-plated copper
- Polyamide has excellent electrical, chemical and mechanical characteristics:
  - temperature resistance: up to 120°C
  - creepage resistance: CTI 600
  - flammability class: self-extinguishing, UL94-V2

# INITIATOR AND ACTUATOR BLOCKS WITH TENSION SPRING CONNECTION

## WKF 1,5 KOI 3L...

- Initiator block with tension spring connection for mounting on TS 35
- Nominal cross section 1.5 mm<sup>2</sup>

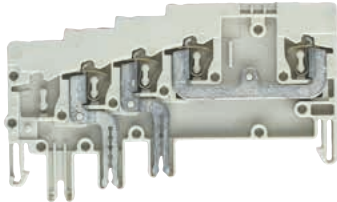

37.702.7453.0  
\* 65 V/1.5 kV/3



37.702.8453.0  
\* DC 24 V  
same as picture,  
but with LED

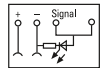

Description	Type	Part No.	Std. Pack	
Initiator block	gray	WKF 1,5 KOI 3L	37.702.7453.0	50
Initiator block with LED	gray	WKF 1,5 KOI 3L-PGE	37.702.8453.0	50

### GENERAL DATA

Width / length / height, incl. TS 7.5	5 mm / 71 mm / 48 mm
Wire strip length	10 mm
Approvals	

### TECHNICAL DATA

IEC	UL	CSA
EN 60947-7-1		
Cross section fine-stranded	0.13 – 1.5 mm <sup>2</sup>	
Cross section solid/stranded	0.13 – 1.5 mm <sup>2</sup>	
Cross section, AWG	22 – 16	28 – 16
Rated current	10 A	10 A
Rated voltage	*	65 V
Rated impulse voltage		65 V
Pollution degree		

### ACCESSORIES

Type	Part No.	Std. Pack	
Wire entry guide	0.13 – 0.2 mm <sup>2</sup> LEL 1,5/1 WEISS	05.562.2453.0	100
	0.25 – 0.5 mm <sup>2</sup> LEL 1,5/2 GRAU	05.562.2553.0	100
	0.75 – 1.0 mm <sup>2</sup> LEL 1,5/3 SCHWARZ	05.562.2653.0	100
Screwdriver, uninsulated	DIN 5264 B 0,6x3,5	06.502.4000.0	5

## WKF 1,5 KOI 3L/SL...

- Initiator block with tension spring connection for mounting on TS 35
- Nominal cross section 1.5 mm<sup>2</sup>

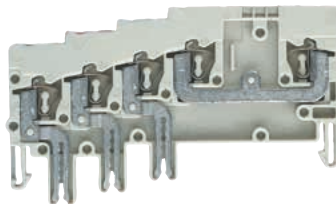

37.702.7553.0  
\* 65 V/1.5 kV/3

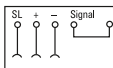

37.702.8553.0  
\* DC 24 V  
same as picture,  
but with LED

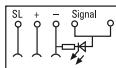

Description	Type	Part No.	Std. Pack	
Initiator block	gray	WKF 1,5 KOI 3L/SL	37.702.7553.0	50
Initiator block with LED	gray	WKF 1,5 KOI 3L/SL-PGE	37.702.8553.0	50

### GENERAL DATA

Width / length / height, incl. TS 7.5	5 mm / 71 mm / 48 mm
Wire strip length	10 mm
Approvals	

### TECHNICAL DATA

IEC	UL	CSA
EN 60947-7-1		
Cross section fine-stranded	0.13 – 1.5 mm <sup>2</sup>	
Cross section solid/stranded	0.13 – 1.5 mm <sup>2</sup>	
Cross section, AWG	22 – 16	28 – 16
Rated current	10 A	10 A
Rated voltage	*	65 V
Rated impulse voltage		65 V
Pollution degree		

### ACCESSORIES

Type	Part No.	Std. Pack	
Wire entry guide	0.13 – 0.2 mm <sup>2</sup> LEL 1,5/1 WEISS	05.562.2453.0	100
	0.25 – 0.5 mm <sup>2</sup> LEL 1,5/2 GRAU	05.562.2553.0	100
	0.75 – 1.0 mm <sup>2</sup> LEL 1,5/3 SCHWARZ	05.562.2653.0	100
Screwdriver, uninsulated	DIN 5264 B 0,6x3,5	06.502.4000.0	5

## WKF 1,5 KOE...

- Supply block with tension spring connection for mounting on TS 35
- Nominal cross section 1.5 mm<sup>2</sup>

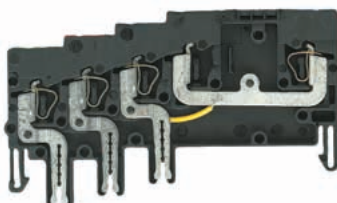

37.702.7753.0  
\* 65 V/1.5 kV/3

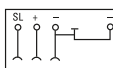

37.702.8753.0  
\* DC 24 V  
same as picture,  
but with LED

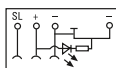

Description	Type	Part No.	Std. Pack	
Supply block	black	WKF 1,5 KOE	37.702.7753.0	50
Supply block with LED	black	WKF 1,5 KOE-PGN	37.702.8753.0	50

### GENERAL DATA

Width / length / height, incl. TS 7.5	5 mm / 71 mm / 48 mm
Wire strip length	10 mm
Approvals	

### TECHNICAL DATA

IEC	UL	CSA
EN 60947-7-1		
Cross section fine-stranded	0.13 – 1.5 mm <sup>2</sup>	
Cross section solid/stranded	0.13 – 1.5 mm <sup>2</sup>	
Cross section, AWG	22 – 16	28 – 16
Rated current	10 A	10 A
Rated voltage	*	65 V
Rated impulse voltage		65 V
Pollution degree		

### ACCESSORIES

Type	Part No.	Std. Pack	
Wire entry guide	0.13 – 0.2 mm <sup>2</sup> LEL 1,5/1 WEISS	05.562.2453.0	100
	0.25 – 0.5 mm <sup>2</sup> LEL 1,5/2 GRAU	05.562.2553.0	100
	0.75 – 1.0 mm <sup>2</sup> LEL 1,5/3 SCHWARZ	05.562.2653.0	100
Screwdriver, uninsulated	DIN 5264 B 0,6x3,5	06.502.4000.0	5



### WKF 1,5 KOA 2L...

- Actuator block with tension spring connection for mounting on TS 35
- Nominal cross section 1.5 mm<sup>2</sup>

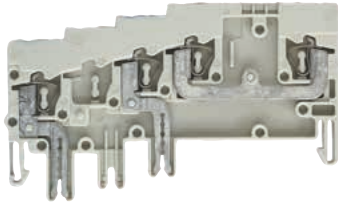

37.702.7653.0  
\* 65 V/1.5 kW/3



37.702.8653.0  
\* DC 24 V  
same as picture,  
but with LED



Description	Type	Part No.	Std. Pack	
Actuator block	gray	WKF 1,5 KOA 2L	37.702.7653.0	50
Actuator block with LED	gray	WKF 1,5 KOA 2L/SL-PGE	37.702.8653.0	50

#### GENERAL DATA

Width / length / height, incl. TS 7.5	5 mm / 71 mm / 48 mm
Wire strip length	10 mm
Approvals	

#### TECHNICAL DATA

	IEC	UL	CSA
	EN 60947-7-1		
Cross section fine-stranded	0.13 – 1.5 mm <sup>2</sup>		
Cross section solid/stranded	0.13 – 1.5 mm <sup>2</sup>		
Cross section, AWG		28 – 16	
Rated current	10 A	10 A	
Rated voltage	*	65 V	
Rated impulse voltage			
Pollution degree			

#### ACCESSORIES

	Type	Part No.	Std. Pack
Wire entry guide	0.13 – 0.2 mm <sup>2</sup> LEL 1,5/1 WEISS	05.562.2453.0	100
	0.25 – 0.5 mm <sup>2</sup> LEL 1,5/2 GRAU	05.562.2553.0	100
	0.75 – 1.0 mm <sup>2</sup> LEL 1,5/3 SCHWARZ	05.562.2653.0	100
Screwdriver, uninsulated	DIN 5264 B 0,6x3,5	06.502.4000.0	5

### VM WKF ...

- Connection module for 9 or 18 blocks

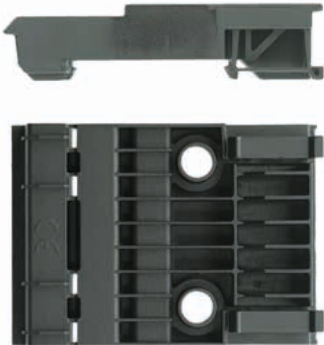

Description	Type	Part No.	Std. Pack	
Connection module for 9 blocks	black	VM WKF KO..9	69.700.0953.0	10
Connection module for 18 blocks	black	VM WKF KO..18	69.700.1853.0	5

#### GENERAL DATA

Length: 9-pole module	L = 9 x 5 mm + 1.5 mm
Length: 18-pole module	L = 18 x 5 mm + 1.5 mm
Approvals	

#### TECHNICAL DATA

	IEC	UL	CSA
	EN 60947-7-1		
Cross section fine-stranded	0.13 – 1.5 mm <sup>2</sup>		
Cross section solid/stranded	0.13 – 1.5 mm <sup>2</sup>		
Cross section, AWG			
Rated current	10 A	10 A	
Rated voltage	*	65 V	
Rated impulse voltage			
Pollution degree			



# FASIS MINI

## DIN RAIL TERMINAL BLOCKS WITH TENSION SPRING CONNECTION

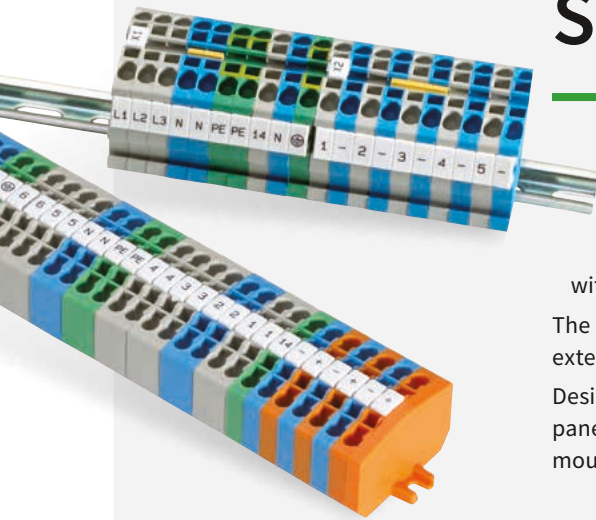

With our DIN rail terminal block system fasis MINI we focus on the application's size and flexibility. fasis MINI is a range of DIN rail terminal blocks in tension spring technology designed for installation in confined spaces.

The portfolio comprises ground blocks and feed-through blocks in various colors with 2 or 4 connections per potential.

The potential in the WKFM 2,5 terminal block series can be distributed, modified and extended quickly, flexibly and without problem by using cross connectors.

Designed to be mounted in various ways, including TS 35 and TS 15 DIN rails, back-panels, or inside distribution boxes, we provide different solutions including snap-on mounting feet, pins, and screw flanges.

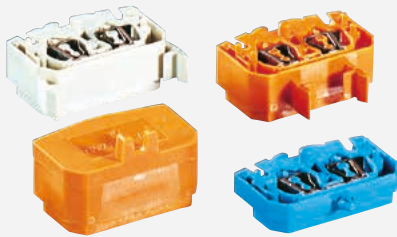

### APPLICATION SPECIFIC OPTIONS

- Miniature terminal blocks with push-in mounting pin for installation directly onto the panel.
- Miniature terminal blocks with screw flange for installation directly onto the panel.
- Miniature terminal blocks for installation on TS 15 or TS 35 mounting rails.

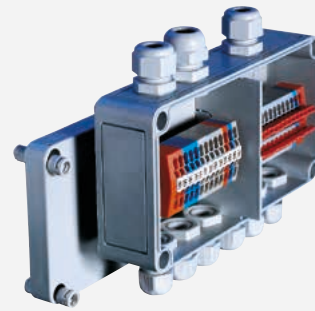

### SOLUTIONS FOR CONFINED SPACES

- Space-saving miniature terminal blocks in many designs for installation inside distribution boxes, motors and applications with confined space requirements.
- Easy wiring with user-friendly screwdriver entry guides at the top of the block.
- Marking tags easily readable even with the wires connected.
- Customized assembly design and marking using wieplot.



### CUSTOMIZED ASSEMBLY

- DIN rail terminal blocks of the fasis MINI series are available in 2 and 4-pole configurations.
- fasis MINI blocks can be snapped together with the integrated latching pins, with or without a mounting rail.
- The various potentials and terminal blocks are visually distinguished by several color variations.
- Individual marking using marking tags or customized printing of the terminal blocks.



### PERMANENT ELECTRICAL CONNECTION

- The tension spring system provides a dynamic clamping connection. Load-controlled and thermal cold flow properties of the connected wires are balanced.
- Maintenance-free and gas-tight electrical connection as specified by the approvals. Customized layouts can be created individually.
- Separation of electrical and mechanical functions.

### WKMF 2,5/15

- Feed-through block with tension spring connection for mounting on TS 15
- Nominal cross section 2.5 mm<sup>2</sup>
- Ex e II II 2GD  
Follow the EX installation instructions on page 174

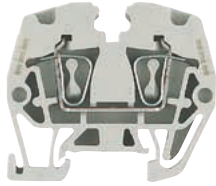

Description	Type	Part No.	Std. Pack
Feed-through block	gray	WKMF 2,5/15	55.703.0053.0 100
Feed-through block	blue	WKMF 2,5/15	55.703.0053.6 100

GENERAL DATA				
Width / length / height, incl. TS 5.5	5 mm / 36 mm / 30 mm			
Wire strip length	10 mm			
Approvals	ATEX		KEMA 03 ATEX 2071 U	
TECHNICAL DATA				
	IEC	UL	CSA	
EN 60 947-7-1	EN 60 079-0/-7			
Cross section fine-stranded	0.13 – 2.5 mm <sup>2</sup>			
Cross section solid/stranded	0.13 – 2.5 mm <sup>2</sup>			
Cross section, AWG	26 – 12		26 – 12	
Rated current	24 A	20 A	20 A	19/20 A <sup>1)</sup>
Rated voltage	500 V	300 V	300 V	275 V <sup>2)</sup>
Rated impulse voltage	6 kV			
Pollution degree	3			

**Note**

<sup>1)</sup> with/without jumper

<sup>2)</sup> For maintaining the proper isolation distances, the open side of feed-through or ground blocks as well as both sides of a jumper are to be covered by partitions.

### WKMF 2,5 SL/15

- Ground block with tension spring connection for mounting on TS 15
- Nominal cross section 2.5 mm<sup>2</sup>
- Ex e II II 2GD  
Follow the EX installation instructions on page 174



Description	Type	Part No.	Std. Pack
Ground block	green/yellow	WKMF 2,5 SL/15	55.703.9053.0 100

GENERAL DATA				
Width / length / height, incl. TS 5.5	5 mm / 36 mm / 30 mm			
Wire strip length	10 mm			
Approvals	ATEX		KEMA 03 ATEX 2071 U	
TECHNICAL DATA				
	IEC	UL	CSA	
EN 60 947-7-2	EN 60 079-0/-7			
Cross section fine-stranded	0.13 – 2.5 mm <sup>2</sup>			
Cross section solid/stranded	0.13 – 2.5 mm <sup>2</sup>			
Cross section, AWG	26 – 12		26 – 12	
Rated current				
Rated voltage	500 V	300 V	300 V	<sup>1)</sup>
Rated impulse voltage	6 kV			
Pollution degree	3			

**Note**

<sup>1)</sup> For maintaining the proper isolation distances, the open side of feed-through or ground blocks as well as both sides of a jumper are to be covered by partitions.

## ACCESSORIES FOR FASIS WKMF 2,5...



ACCESSORIES	Type	Part No.	Std. Pack
End plate, 1.5 mm wide	gray	APMF 2,5 /15	07.312.5953.0 10
Cross connector, insulated	2-pole	IVB WKMF 2,5 – 2	Z7.260.0229.0 10
	3-pole	IVB WKMF 2,5 – 3	Z7.260.0329.0 10
	4-pole	IVB WKMF 2,5 – 4	Z7.260.0429.0 10
	5-pole	IVB WKMF 2,5 – 5	Z7.260.0529.0 10
	10-pole	IVB WKMF 2,5 – 10	Z7.260.1029.0 10
	50-pole	IVB WKMF 2,5 M50	Z7.260.0029.0 10
Screwdriver, uninsulated	DIN 5264 B 0,6x3,5		06.502.4000.0 5
Screwdriver, uninsulated, MINI	DIN 5264 B 0,6x3,5 M		06.502.5000.0 10

# MINI TERMINAL BLOCKS WITH TENSION SPRING CONNECTION

## WKF 2,5/M WITH FLANGE

- Feed-through block with tension spring connection with or without flange
- Nominal cross section 2.5 mm<sup>2</sup>



WKF 2,5/M/F



WKF 2,5/M

Description	Type	Part No.	Std. Pack
Feed-through block unmarked	gray WKF 2,5/M	37.703.0553.0	100
Feed-through block unmarked	blue WKF 2,5/M BLAU	37.703.0553.6	100
Feed-through block unmarked	orange WKF 2,5/M ORANGE	37.703.0553.9	100
Feed-through block with flange	gray WKF 2,5/M/F	39.703.0153.0	100
Feed-through block with flange	blue WKF 2,5/M/F BLAU	39.703.0153.6	100
Feed-through block with flange	orange WKF 2,5/M/F ORANGE	39.703.0153.9	100

### GENERAL DATA

Width / length / height	5 mm / 36 mm / 23 mm
Wire strip length	11 mm
Approvals	

### TECHNICAL DATA

IEC	UL	CSA
EN 60947-7-1		
Cross section fine-stranded		
	0.13 – 2.5 mm <sup>2</sup>	
Cross section solid/stranded		
	0.13 – 4 mm <sup>2</sup>	
Cross section, AWG	22 – 12	24 – 12
Rated current	24 A	20 A
Rated voltage	800 V	600 V
Rated impulse voltage	8 kV	600 V
Pollution degree	3	3

## WKF 2,5/MD WITH FLANGE

- Duo feed-through block with tension spring connection with or without flange
- Nominal cross section 2.5 mm<sup>2</sup>



WKF 2,5/MD/F



WKF 2,5/MD

Description	Type	Part No.	Std. Pack
Duo feed-through block unmarked	gray WKF 2,5/MD	37.703.1053.0	100
Duo feed-through block unmarked	blue WKF 2,5/MD BLAU	37.703.1053.6	100
Duo feed-through block unmarked	orange WKF 2,5/MD ORANGE	37.703.1053.9	100
Duo feed-through block with flange	gray WKF 2,5/MD/F	39.703.0253.0	100
Duo feed-through block with flange	blue WKF 2,5/MD/F BLAU	39.703.0253.6	100
Duo feed-through block with flange	orange WKF 2,5/MD/F ORANGE	39.703.0253.9	100

### GENERAL DATA

Width / length / height	10 mm / 36 mm / 23 mm
Wire strip length	11 mm
Approvals	

### TECHNICAL DATA

IEC	UL	CSA
EN 60947-7-1		
Cross section fine-stranded		
	0.13 – 2.5 mm <sup>2</sup>	
Cross section solid/stranded		
	0.13 – 4 mm <sup>2</sup>	
Cross section, AWG	22 – 12	24 – 12
Rated current	24 A	20 A
Rated voltage	800 V	600 V
Rated impulse voltage	8 kV	600 V
Pollution degree	3	3

# ACCESSORIES FOR FASIS WKF 2,5/M...

ACCESSORIES	Type	Part No.	Std. Pack
End plate with flange on the right	gray APF 2,5/M.../F/R	07.312.3153.0	10
End plate with flange on the right	blue APF 2,5/M.../F/R BLAU	07.312.3153.6	10
End plate with flange on the right	orange APF 2,5/M.../F/R ORANGE	07.312.3153.9	10
Wire entry guide	0.13 – 0.2 mm <sup>2</sup> LEL 2,5/1 WEISS	05.561.6553.0	100
Wire entry guide	0.25 – 0.5 mm <sup>2</sup> LEL 2,5/2 GRAU	05.561.6653.0	100
Wire entry guide	0.75 – 1.0 mm <sup>2</sup> LEL 2,5/3 SCHWARZ	05.561.6753.0	100
Cross connector, insulated	2-pole	05.902.3500.0	10
Marking strip, unmarked	(4 x 22 pcs.)	04.244.0053.0	5
marked	(1 – 11)	04.844.2053.0	5
marked	(12 – 55)	04.844.2153.0	5
marked	(56 – 99)	04.844.2253.0	5
Screwdriver, uninsulated	DIN 5264 B 0,6 x 3,5	06.502.4000.0	5

### WKF 2,5/M/R WITH MOUNTING FOOT

- Feed-through block with tension spring connection, unmarked
- Nominal cross section 2.5 mm<sup>2</sup>



Mounting hole: Ø 3,5 mm  
Plate thickness: 0,6 – 1,2 mm

Description	Type	Part No.	Std. Pack
Feed-through block unmarked	gray WKF 2,5/M/R	38.703.0553.0	100
Feed-through block unmarked	blue WKF 2,5/M/R BLAU	38.703.0553.6	100
Feed-through block unmarked	orange WKF 2,5/M/R ORANGE	38.703.0553.9	100

GENERAL DATA			
Width / length / height	5 mm / 36 mm / 23 mm		
Wire strip length	11 mm		
Approvals			

TECHNICAL DATA	IEC	UL	CSA
	EN 60947-7-1		
Cross section fine-stranded	0.13 – 2.5 mm <sup>2</sup>		
Cross section solid/stranded	0.13 – 4 mm <sup>2</sup>		
Cross section, AWG		22 – 12	24 – 12
Rated current	24 A	20 A	25 A
Rated voltage	800 V	600 V	600 V
Rated impulse voltage	8 kV		
Pollution degree	3		

### WKF 2,5/MD/R WITH MOUNTING FOOT

- Duo feed-through block with tension spring connection, unmarked
- Nominal cross section 2.5 mm<sup>2</sup>



Mounting hole: Ø 3,5 mm  
Plate thickness: 0,6 – 1,2 mm

Description	Type	Part No.	Std. Pack
Duo feed-through block unmarked	gray WKF 2,5/MD/R	38.703.1053.0	100
Duo feed-through block unmarked	blue WKF 2,5/MD/R BLAU	38.703.1053.6	100
Duo feed-through block unmarked	orange WKF 2,5/MD/R ORANGE	38.703.1053.9	100

GENERAL DATA			
Width / length / height	10 mm / 36 mm / 23 mm		
Wire strip length	11 mm		
Approvals			

TECHNICAL DATA	IEC	UL	CSA
	EN 60947-7-1		
Cross section fine-stranded	0.13 – 2.5 mm <sup>2</sup>		
Cross section solid/stranded	0.13 – 4 mm <sup>2</sup>		
Cross section, AWG		22 – 12	24 – 12
Rated current	24 A	20 A	25 A
Rated voltage	800 V	600 V	600 V
Rated impulse voltage	8 kV		
Pollution degree	3		

## ACCESSORIES FOR FASIS WKF 2,5/M.../R

ACCESSORIES	Type	Part No.	Std. Pack
End plate	gray APF 2,5/M...	07.312.2953.0	10
End plate	blue APF 2,5/M... BLAU	07.312.2953.6	10
End plate	orange APF 2,5/M... ORANGE	07.312.2953.9	10
Wire entry guide	0.13 – 0.2 mm <sup>2</sup> LEL 2,5/1 WEISS	05.561.6553.0	100
Wire entry guide	0.25 – 0.5 mm <sup>2</sup> LEL 2,5/2 GRAU	05.561.6653.0	100
Wire entry guide	0.75 – 1.0 mm <sup>2</sup> LEL 2,5/3 SCHWARZ	05.561.6753.0	100
Cross connector, insulated	2-pole	05.902.3500.0	10
Marking strip, unmarked	(4 x 22 pcs.)	04.244.0053.0	5
marked	(1 – 11)	04.844.2053.0	5
marked	(12 – 55)	04.844.2153.0	5
marked	(56 – 99)	04.844.2253.0	5
Screwdriver, uninsulated	DIN 5264 B 0,6 x 3,5	06.502.4000.0	5



# MINI TERMINAL BLOCKS WITH TENSION SPRING CONNECTION

## WKF 2,5/M/15

- Feed-through block with tension spring connection, unmarked, for mounting on TS 15
- Nominal cross section 2.5 mm<sup>2</sup>



Description	Type	Part No.	Std. Pack
Feed-through block unmarked	gray WKF 2,5/M/15	55.703.0553.0	100
Feed-through block unmarked	blue WKF 2,5/M/15 BLAU	55.703.0553.6	100
Feed-through block unmarked	orange WKF 2,5/M/15 ORANGE	55.703.0553.9	100
Feed-through block unmarked	green WKF 2,5/M/15 GRÜN	55.703.0553.7	100

### GENERAL DATA

Width / length / height, incl. TS 5.5	5 mm / 36 mm / 27 mm
Wire strip length	11 mm
Approvals	

TECHNICAL DATA	IEC	UL	CSA
	EN 60947-7-1		
Cross section fine-stranded	0.13 – 2.5 mm <sup>2</sup>		
Cross section solid/stranded	0.13 – 4 mm <sup>2</sup>		
Cross section, AWG		22 – 12	24 – 12
Rated current	24 A	20 A	25 A
Rated voltage	800 V	600 V	600 V
Rated impulse voltage	8 kV		
Pollution degree	3		

## WKF 2,5/MD/15

- Duo feed-through block with tension spring connection, unmarked, for mounting on TS 15
- Nominal cross section 2.5 mm<sup>2</sup>



Description	Type	Part No.	Std. Pack
Duo feed-through block unmarked	gray WKF 2,5/MD/15	55.703.1053.0	100
Duo feed-through block unmarked	blue WKF 2,5/MD/15 BLAU	55.703.1053.6	100
Duo feed-through block unmarked	orange WKF 2,5/MD/15 ORANGE	55.703.1053.9	100
Duo feed-through block unmarked	green WKF 2,5/MD/15 GRÜN	55.703.1053.7	100

### GENERAL DATA

Width / length / height, incl. TS 5.5	10 mm / 36 mm / 27 mm
Wire strip length	11 mm
Approvals	

TECHNICAL DATA	IEC	UL	CSA
	EN 60947-7-1		
Cross section fine-stranded	0.13 – 2.5 mm <sup>2</sup>		
Cross section solid/stranded	0.13 – 4 mm <sup>2</sup>		
Cross section, AWG		22 – 12	24 – 12
Rated current	24 A	20 A	25 A
Rated voltage	800 V	600 V	600 V
Rated impulse voltage	8 kV		
Pollution degree	3		

## WKF 2,5/M/35

- Feed-through block with tension spring connection, unmarked, for mounting on TS 35
- Nominal cross section 2.5 mm<sup>2</sup>



Description	Type	Part No.	Std. Pack
Feed-through block unmarked	gray WKF 2,5/M/35	56.703.0553.0	100
Feed-through block unmarked	blue WKF 2,5/M/35 BLAU	56.703.0553.6	100
Feed-through block unmarked	orange WKF 2,5/M/35 ORANGE	56.703.0553.9	100
Feed-through block unmarked	green WKF 2,5/M/35 GRÜN	56.703.0553.7	100

### GENERAL DATA

Width / length / height, incl. TS 7.5	5 mm / 36 mm / 32 mm
Wire strip length	11 mm
Approvals	

TECHNICAL DATA	IEC	UL	CSA
	EN 60947-7-1		
Cross section fine-stranded	0.13 – 2.5 mm <sup>2</sup>		
Cross section solid/stranded	0.13 – 4 mm <sup>2</sup>		
Cross section, AWG		22 – 12	24 – 12
Rated current	24 A	20 A	25 A
Rated voltage	800 V	600 V	600 V
Rated impulse voltage	8 kV		
Pollution degree	3		

## WKF 2,5/MD/35

- Duo-Feed-through block with tension spring connection, unmarked, for mounting on TS 35
- Nominal cross section 2.5 mm<sup>2</sup>



Description	Type	Part No.	Std. Pack
Duo-Feed-through block unmarked	gray WKF 2,5/MD/35	56.703.1053.0	100
Duo-Feed-through block unmarked	blue WKF 2,5/MD/35 BLAU	56.703.1053.6	100
Duo-Feed-through block unmarked	orange WKF 2,5/MD/35 ORANGE	56.703.1053.9	100
Duo-Feed-through block unmarked	green WKF 2,5/MD/35 GRÜN	56.703.1053.7	100

### GENERAL DATA

Width / length / height, incl. TS 7.5	10 mm / 36 mm / 32 mm
Wire strip length	11 mm
Approvals	

TECHNICAL DATA	IEC	UL	CSA
	EN 60947-7-1		
Cross section fine-stranded	0.13 – 2.5 mm <sup>2</sup>		
Cross section solid/stranded	0.13 – 4 mm <sup>2</sup>		
Cross section, AWG		22 – 12	24 – 12
Rated current	24 A	20 A	25 A
Rated voltage	800 V	600 V	600 V
Rated impulse voltage	8 kV		
Pollution degree	3		

## ACCESSORIES FOR FASIS WKF 2,5/M...

ACCESSORIES	Type	Part No.	Std. Pack
End plate	gray APF 2,5/M...	07.312.2953.0	10
End plate	blue APF 2,5/M... BLAU	07.312.2953.6	10
End plate	orange APF 2,5/M... ORANGE	07.312.2953.9	10
Wire entry guide	0.13 – 0.2 mm <sup>2</sup> LEL 2,5/1 WEISS	05.561.6553.0	100
Wire entry guide	0.25 – 0.5 mm <sup>2</sup> LEL 2,5/2 GRAU	05.561.6653.0	100
Wire entry guide	0.75 – 1.0 mm <sup>2</sup> LEL 2,5/3 SCHWARZ	05.561.6753.0	100
Cross connector, insulated	2-pole	05.902.3500.0	10
Marking strip, unmarked	(4 x 22 pcs.)	04.244.0053.0	5
marked	(1 – 11)	04.844.2053.0	5
marked	(12 – 55)	04.844.2153.0	5
marked	(56 – 99)	04.844.2253.0	5
Screwdriver, uninsulated	DIN 5264 B 0,6 x 3,5	06.502.4000.0	5



# FASIS BIT

## DIN RAIL TERMINALS FOR **INSTALLATION DISTRIBUTION BOARDS** WITH TENSION SPRING CONNECTION

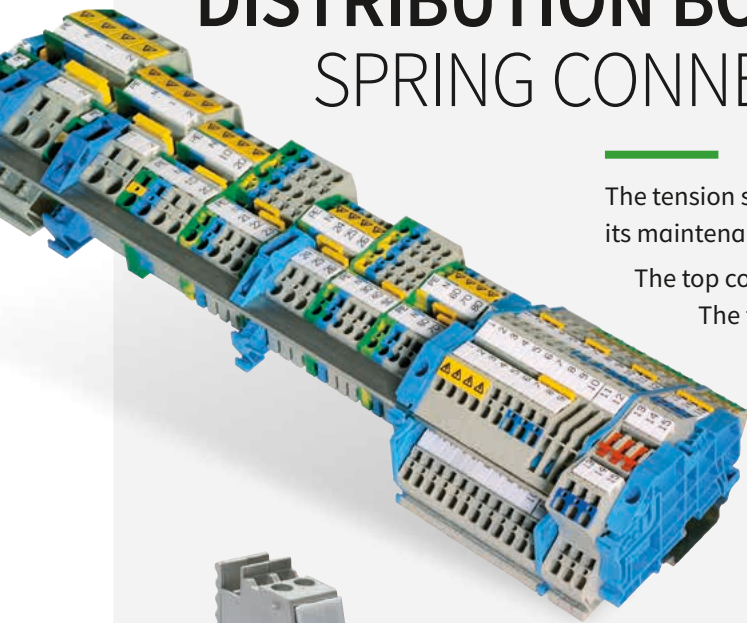

The tension spring connection of the fasis BIT series impresses users with its maintenance-free and vibration-proof connection mechanism.

The top connection from above is especially suitable for tight spaces.

The fasis BIT is designed for use in distribution systems and takes into account the standardized dimensions for small distributors and field distributors with covers in accordance with DIN 43871.

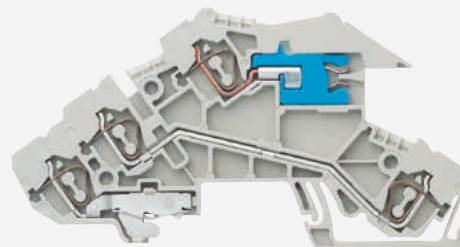

### SIMPLE TESTING

- Function test with modular test adapter
- Integrated test jacks in all blocks

### SPACE-SAVING WIRING

- Clear wiring and assignment of electrical circuits through three-story design in 5 mm assembly width
- Neutral conductor, current throughput, and green conductor connection in just one terminal
- Safety and convenience through switchable N disconnect function

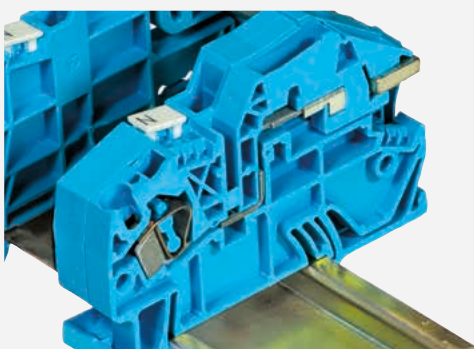

### CONVENIENT SWITCHING AND OPERATION

- Screwless, maintenance-free spring-force device
- Easy conductor feed and operation from above
- Safety and operation convenience even with disconnection of the neutral conductor from the neutral busbar for insulation measurement using slide-gate valve with optical control.

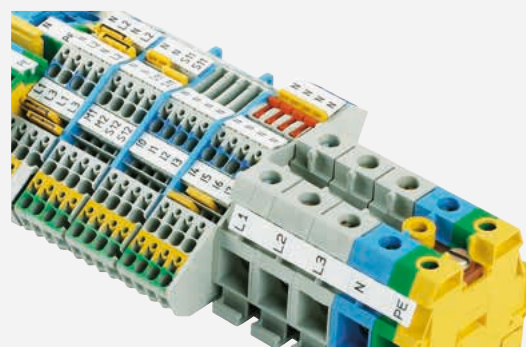

### COMBINABLE IN THE SYSTEM

- Problem-free combination of installation terminals with other Wieland terminal blocks, also with different connection equipment
- For example:
  - Circuit wiring with compact spring-force device fasis BIT
  - Power feed with proven selos screw technology
- Low storage and logistics expense due to uniform accessories

# NEUTRAL DISCONNECT BLOCKS FOR INSTALLATION DISTRIBUTION BOARDS WITH TENSION SPRING CONNECTION



## WKF 4 NT

- Neutral disconnect block with tension spring connection for mounting on TS 35
- Nominal cross section 4 mm<sup>2</sup>

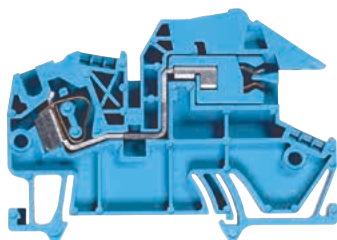

Description	Type	Part No.	Std. Pack	
Neutral disconnect terminal	blue WKF 4 NT / 35	56.704.8153.0	100	
<b>GENERAL DATA</b>				
Width / length / height, incl. TS 7.5	6 mm / 69.5 mm / 51.2 mm			
Wire strip length	11 mm			
Approvals				
<b>TECHNICAL DATA</b>				
	<b>IEC</b>	<b>UL</b>	<b>CSA</b>	<b>EX</b>
	EN 60 947-7-1			
Cross section fine-stranded	0.14-4 mm <sup>2</sup>			
Cross section solid/stranded	0.14-6 mm <sup>2</sup>			
Cross-section, AWG	22-10 AWG			
Rated current	25 A			
Rated voltage	400 V			
Rated impulse voltage	6 kV			
Pollution degree	3			
<b>ACCESSORIES</b>				
End plate	APF 4 NT	07.312.5653.0	10	
Jumper bar	2-pole IVBWK 4 - 2	Z7.261.1227.0	10	
	3-pole IVBWK 4 - 3	Z7.261.1327.0	10	
	10-pole IVBWK 4 - 10	Z7.261.2027.0	20	
Busbar	9813 M SN 10X3 1000MM	98.290.1000.0	1	
Connection clamp for busbar	WAK16/2 BL/V0	30.494.3021.6	100	
Connection clamp for busbar	WAK35/2 BL/V0	30.494.4021.6	100	
Connection clamp for busbar	WAK35/2	30.494.4121.0	50	

## WKF 10 NT

- Neutral disconnect block with tension spring connection for mounting on TS 35
- Nominal cross section 10 mm<sup>2</sup>
- Enclosed design

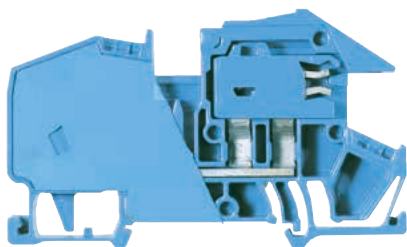

Description	Type	Part No.	Std. Pack	
Neutral disconnect terminal	blue WKF 10 NT/35	56.710.8153.0	50	
<b>GENERAL DATA</b>				
Width / length / height, incl. TS 7.5	10 mm / 82 mm / 51.2 mm			
Wire strip length	13 mm			
Approvals				
<b>TECHNICAL DATA</b>				
	<b>IEC</b>	<b>UL</b>	<b>CSA</b>	<b>EX</b>
	EN 60 947-7-1			
Cross section fine-stranded	2.5-10 mm <sup>2</sup>			
Cross section solid/stranded	2.5-10 mm <sup>2</sup>			
Cross-section, AWG				
Rated current	57 A			
Rated voltage	400 V			
Rated impulse voltage	6 kV			
Pollution degree	3			
<b>ACCESSORIES</b>				
Jumper bar	2-pole IVBWK 10- 2	Z7.283.8227.0	10	
Busbar	9813 M SN 10X3 1000MM	98.290.1000.0	1	
Connection clamp for busbar	WAK16/2 BL/V0	30.494.3021.6	100	
Connection clamp for busbar	WAK35/2 BL/V0	30.494.4021.6	100	
Connection clamp for busbar	WAK35/2	30.494.4121.0	50	

## WKIF 16 NT

- Neutral disconnect block with tension spring connection for mounting on TS 35
- Nominal cross section 16 mm<sup>2</sup>
- Enclosed design

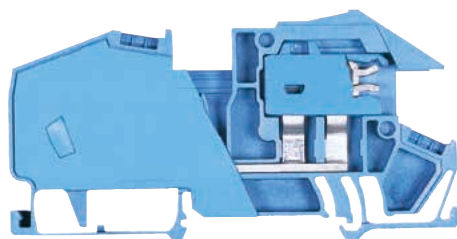

Description	Type	Part No.	Std. Pack	
Neutral disconnect terminal	blue WKIF 16/1 NT/35	56.716.8155.0	20	
<b>GENERAL DATA</b>				
Width / length / height, incl. TS 7.5	12 mm / 94 mm / 51.2 mm			
Wire strip length	15 mm			
Approvals				
<b>TECHNICAL DATA</b>				
	<b>IEC</b>	<b>UL</b>	<b>CSA</b>	<b>EX</b>
	EN 60 947-7-1			
Cross section fine-stranded	4-16 mm <sup>2</sup>			
Cross section solid/stranded	4-16 mm <sup>2</sup>			
Cross-section, AWG				
Rated current	76 A			
Rated voltage	400 V			
Rated impulse voltage	6 kV			
Pollution degree	3			
<b>ACCESSORIES</b>				
Jumper bar	2-pole IVBWK 16- 2	Z7.284.4227.0	10	
Busbar	9813 M SN 10X3 1000MM	98.290.1000.0	1	
Connection clamp for busbar	WAK16/2 BL/V0	30.494.3021.6	100	
Connection clamp for busbar	WAK35/2 BL/V0	30.494.4021.6	100	
Connection clamp for busbar	WAK35/2	30.494.4121.0	50	

# FEED-THROUGH BLOCKS FOR INSTALLATION DISTRIBUTION BOARDS WITH TENSION SPRING CONNECTION

## WKF 2.5

- Feed-through block with tension spring connection for mounting on TS 35
- Nominal cross section 2.5 mm<sup>2</sup>



Description	Type	Part No.	Std. Pack
Feed-through terminal	gray WKF 2,5 / 35	56.703.0053.0	100
	blue WKF 2,5 / 35 BLAU	56.703.0053.6	100
Feed-through terminal block green/yellow	WKF 2,5 SL / 35	56.703.9053.0	100

GENERAL DATA				
Width / length / height, incl. TS 7.5	5 mm / 5 mm / 42.3 mm			
Wire strip length	11 mm			
Approvals				

TECHNICAL DATA	IEC	UL	CSA	EX
	EN 60 947-7-1			
Cross section fine-stranded	0.13-2.5 mm <sup>2</sup>			
Cross section solid/stranded	0.13-4 mm <sup>2</sup>			
Cross-section, AWG		22-12 AWG	24-12 AWG	
Rated current	24 A	20 A	20 A	
Rated voltage	800 V	600 V	600 V	
Rated impulse voltage	8 kV			
Pollution degree	3			

ACCESSORIES	Type	Part No.	Std. Pack
End plate	APF 2,5 - 4	07.312.2153.0	10
Partition	TWF 2,5 - 4	07.312.2253.0	10
Jumper bar	2-pole IBWKF 2,5 - 2	Z7.280.6227.0	10
	3-pole IBWKF 2,5 - 3	Z7.280.6327.0	10
	10-pole IBWKF 2,5 - 10	Z7.280.7027.0	20

## WKF 4

- Feed-through block with tension spring connection for mounting on TS 35
- Nominal cross section 4 mm<sup>2</sup>

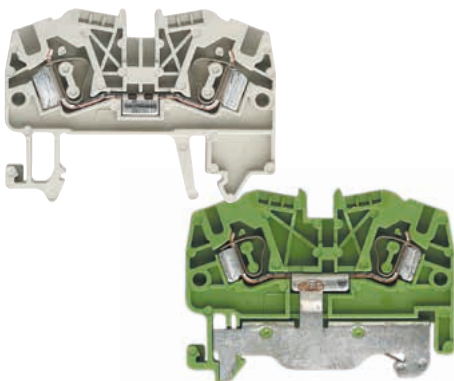

Description	Type	Part No.	Std. Pack
Feed-through terminal	gray WKF 4 / 35	56.704.0053.0	100
	blue WKF 4 / 35 BLAU	56.704.0053.6	100
Feed-through terminal block green/yellow	WKF 4 SL / 35/V0	56.704.9053.0	100

GENERAL DATA				
Width / length / height, incl. TS 7.5	6 mm / 57 mm / 42.3 mm			
Wire strip length	11 mm			
Approvals				

TECHNICAL DATA	IEC	UL	CSA	EX
	EN 60 947-7-1			
Cross section fine-stranded	0.13-4 mm <sup>2</sup>			
Cross section solid/stranded	0.13 - 6 mm <sup>2</sup>			
Cross-section, AWG		22-10 AWG	22-10 AWG	
Rated current	32 A	20 A	20 A	
Rated voltage	800 V	600 V	600 V	
Rated impulse voltage	8 kV			
Pollution degree	3			

ACCESSORIES	Type	Part No.	Std. Pack
End plate	APF 2,5 - 4	07.312.2153.0	10
Partition	TWF 2,5 - 4	07.312.2253.0	10
Jumper bar	2-pole IBWKF 4 - 2	Z7.261.1227.0	10
	3-pole IBWKF 4 - 3	Z7.261.1327.0	10
	10-pole IBWKF 4 - 10	Z7.261.2027.0	20

## WKF 6

- Feed-through block with tension spring connection for mounting on TS 35
- Nominal cross section 6 mm<sup>2</sup>
- Enclosed design

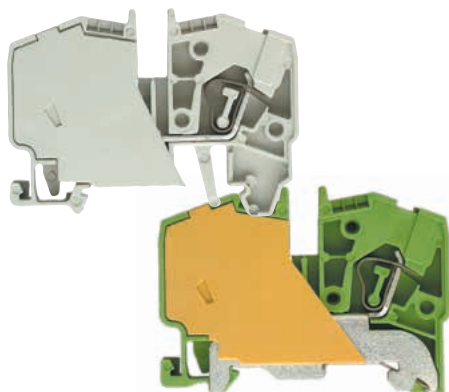

Description	Type	Part No.	Std. Pack
Feed-through terminal	gray WKF 6/35	56.706.0053.0	100
	blue WKF 6/35 BLAU	56.706.0053.6	100
Feed-through terminal block green/yellow	WKF 6SL/35	56.706.9053.0	100

GENERAL DATA				
Width / length / height, incl. TS 7.5	8 mm / 61 mm / 45.1 mm			
Wire strip length	12 mm			
Approvals				

TECHNICAL DATA	IEC	UL	CSA	EX
	EN 60 947-7-1			
Cross section fine-stranded	0.5 - 6 mm <sup>2</sup>			
Cross section solid/stranded	0.5 - 6 mm <sup>2</sup>			
Cross-section, AWG		20-10 AWG	20-10 AWG	
Rated current	41 A	40 A	40 A	
Rated voltage	800 V	600 V	600 V	
Rated impulse voltage	8 kV			
Pollution degree	3			

ACCESSORIES	Type	Part No.	Std. Pack
Jumper bar	2-pole IBWKF 6- 2	Z7.282.4227.0	10



### WKF 10

- Feed-through block with tension spring connection for mounting on TS 35
- Nominal cross section 10 mm<sup>2</sup>
- Enclosed design



Description	Type	Part No.	Std. Pack
Feed-through terminal	gray WKF 10/35	56.710.0053.0	50
	blue WKF 10/35 BLAU	56.710.0053.6	50
Feed-through terminal block green/yellow	WKF 10SL/35	56.710.9053.0	50

GENERAL DATA				
Width / length / height, incl. TS 7.5	10 mm / 70 mm / 47.5 mm			
Wire strip length	13 mm			
Approvals				

TECHNICAL DATA	IEC	UL	CSA	EX
	EN 60 947-7-1			
Cross section fine-stranded	2.5-10 mm <sup>2</sup>			
Cross section solid/stranded	2.5-10 mm <sup>2</sup>			
Cross-section, AWG		14-8 AWG	14-8 AWG	
Rated current	57 A	55 A	55 A	
Rated voltage	800 V	600 V	600 V	
Rated impulse voltage	8 kV			
Pollution degree	3			

ACCESSORIES	Type	Part No.	Std. Pack
Jumper bar	2-pole IVBWK 10- 2	Z7.283.8227.0	10

### WKIF 16

- Feed-through block with tension spring connection for mounting on TS 35
- Nominal cross section 16 mm<sup>2</sup>
- Enclosed design

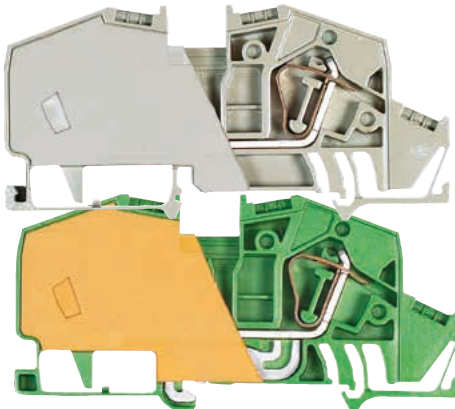

Description	Type	Part No.	Std. Pack
Feed-through terminal	gray WKIF 16/1 /35	56.716.1155.0	20
	blue WKIF 16/1 /35 BLAU	56.716.1155.6	20
Feed-through terminal block green/yellow	WKIF 16/1 SL/35	56.716.9155.0	20

GENERAL DATA				
Width / length / height, incl. TS 7.5	12 mm / 94 mm / 47.7 mm			
Wire strip length	16 mm			
Approvals				

TECHNICAL DATA	IEC	UL	CSA	EX
	EN 60 947-7-1			
Cross section fine-stranded	4-16 mm <sup>2</sup>			
Cross section solid/stranded	4-16 mm <sup>2</sup>			
Cross-section, AWG				
Rated current	76 A			
Rated voltage	800 V			
Rated impulse voltage	8 kV			
Pollution degree	3			

ACCESSORIES	Type	Part No.	Std. Pack
Jumper bar	2-pole IVBWK 16- 2	Z7.284.4227.0	10

### WKF 16

- Feed-through block with tension spring connection for mounting on TS 35
- Nominal cross section 16 mm<sup>2</sup>
- Enclosed design



Description	Type	Part No.	Std. Pack
Feed-through terminal	gray WKF 16/35	56.716.0053.0	50
	blue WKF 16/35 BLAU	56.716.0053.6	50
Feed-through terminal block green/yellow	WKF 16SL/35	56.716.9053.0	50

GENERAL DATA				
Width / length / height, incl. TS 7.5	12 mm / 82 mm / 47.7 mm			
Wire strip length	15 mm			
Approvals				

TECHNICAL DATA	IEC	UL	CSA	EX
	EN 60 947-7-1			
Cross section fine-stranded	4-16 mm <sup>2</sup>			
Cross section solid/stranded	4-16 mm <sup>2</sup>			
Cross-section, AWG		24-4 AWG	12-4 AWG	
Rated current	76 A	75 A	75 A	
Rated voltage	800 V	600 V	600 V	
Rated impulse voltage	8 kV			
Pollution degree	3			

ACCESSORIES	Type	Part No.	Std. Pack
Jumper bar	2-pole IVBWK 16- 2	Z7.284.4227.0	10

# MULTI-TIER TERMINALS FOR INSTALLATION DISTRIBUTION BOARDS WITH TENSION SPRING CONNECTION

## WKIF 2.5 D

- Installation multi-tier terminal with tension spring connection for mounting on TS 35
- Nominal cross section 2.5 mm<sup>2</sup>



Description	Type	Part No.	Std. Pack
Installation rail terminal blocks	WKIF 2,5 D	56.703.9653.0	50

GENERAL DATA				
Width / length / height, incl. TS 7.5	5 mm / 95 mm / 51.2 mm			
Wire strip length	11 mm			
Approvals				
TECHNICAL DATA				
	IEC	UL	CSA	EX
	EN 60 947-7-1			
Cross section fine-stranded	0.14-2.5 mm <sup>2</sup>			
Cross section solid/stranded	0.14-4 mm <sup>2</sup>			
Cross-section, AWG		22-12 AWG	22-14 AWG	
Rated current	24 A	20 A	20 A	
Rated voltage	400 V		300 V	
Rated impulse voltage	6 kV			
Pollution degree	3			

ACCESSORIES				
	Type	Part No.	Std. Pack	
End plate	APIF 2,5	07.311.8353.0	10	
Jumper bar	2-pole	IVBWK 2,5 - 2	10	
	3-pole	IVBWK 2,5 - 3	10	
	4-pole	IVBWK 2,5 - 4	10	
	5-pole	IVBWK 2,5 - 5	10	
	10-pole	IVBWK 2,5 - 10	20	
Busbar	9813 M SN 10X3 1000MM	98.290.1000.0	1	

## WKIF 2.5 D-D

## WKIF 2,5 N-D

- Installation multi-tier terminal with tension spring connection for mounting on TS 35
- Nominal cross section 2.5 mm<sup>2</sup>

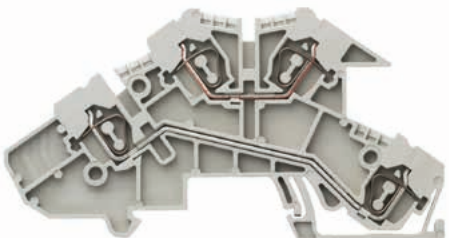

Description	Type	Part No.	Std. Pack
Installation rail terminal blocks	WKIF 2,5 D-D	56.703.9753.0	50
	WKIF 2,5 N-D	56.703.9953.0	50

GENERAL DATA				
Width / length / height, incl. TS 7.5	5 mm / 95 mm / 51.2 mm			
Wire strip length	11 mm			
Approvals				
TECHNICAL DATA				
	IEC	UL	CSA	EX
	EN 60 947-7-1			
Cross section fine-stranded	0.14-2.5 mm <sup>2</sup>			
Cross section solid/stranded	0.14-4 mm <sup>2</sup>			
Cross-section, AWG		22-12 AWG	22-14 AWG	
Rated current	24 A	20 A	20 A	
Rated voltage	400 V		300 V	
Rated impulse voltage	4 kV			
Pollution degree	3			

ACCESSORIES				
	Type	Part No.	Std. Pack	
End plate	APIF 2,5	07.311.8353.0	10	
Jumper bar	2-pole	IVBWK 2,5 - 2	10	
	3-pole	IVBWK 2,5 - 3	10	
	10-pole	IVBWK 2,5 - 10	20	
Busbar	9813 M SN 10X3 1000MM	98.290.1000.0	1	

## WKIF 2.5 D-D-SL

## WKIF 2.5 N-D-SL

- Installation multi-tier terminal with tension spring connection for mounting on TS 35
- Nominal cross section 2.5 mm<sup>2</sup>



Description	Type	Part No.	Std. Pack
Installation rail terminal blocks	WKIF 2,5 D-D-SL	56.703.9853.0	50
	WKIF 2,5 N-D-SL	56.703.9453.0	50

GENERAL DATA				
Width / length / height, incl. TS 7.5	5 mm / 95 mm / 51.2 mm			
Wire strip length	11 mm			
Approvals				
TECHNICAL DATA				
	IEC	UL	CSA	EX
	EN 60 947-7-1			
Cross section fine-stranded	0.14-2.5 mm <sup>2</sup>			
Cross section solid/stranded	0.14-4 mm <sup>2</sup>			
Cross-section, AWG		22-12 AWG	22-14 AWG	
Rated current	24 A	20 A	20 A	
Rated voltage	400 V		300 V	
Rated impulse voltage	4 kV			
Pollution degree	3			

ACCESSORIES				
	Type	Part No.	Std. Pack	
End plate	APIF 2,5	07.311.8353.0	10	
Jumper bar	2-pole	IVBWK 2,5 - 2	10	
	3-pole	IVBWK 2,5 - 3	10	
	10-pole	IVBWK 2,5 - 10	20	
Busbar	9813 M SN 10X3 1000MM	98.290.1000.0	1	

### WKIF 2.5 NT-D-SL

- Installation multi-tier terminal with tension spring connection for mounting on TS 35
- Nominal cross section 2.5 mm<sup>2</sup>

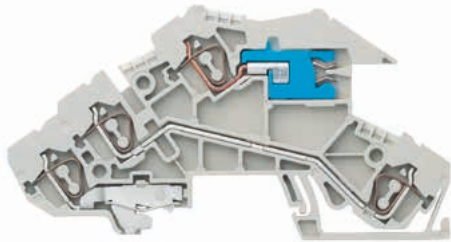

Description	Type	Part No.	Std. Pack
Installation rail terminal blocks	WKIF 2,5 NT-D-SL	56.703.9553.0	50

#### GENERAL DATA

Width / length / height, incl. TS 7.5	5 mm / 95 mm / 51.2 mm
Wire strip length	11 mm
Approvals	

TECHNICAL DATA	IEC	UL	CSA	EX
	EN 60 947-7-1			
Cross section fine-stranded	0.14-2.5 mm <sup>2</sup>			
Cross section solid/stranded	0.14-4 mm <sup>2</sup>			
Cross-section, AWG		22-12 AWG	22-14 AWG	
Rated current	20 A	20 A	20 A	
Rated voltage	400 V		300 V	
Rated impulse voltage	6 kV			
Pollution degree	3			

ACCESSORIES	Type	Part No.	Std. Pack
End plate	APIF 2,5	07.311.8353.0	10
Jumper bar	2-pole IVBWK 2,5 - 2	Z7.280.6227.0	10
	3-pole IVBWK 2,5 - 3	Z7.280.6327.0	10
	4-pole IVBWK 2,5 - 4	Z7.280.6427.0	10
	5-pole IVBWK 2,5 - 5	Z7.280.6527.0	10
	10-pole IVBWK 2,5 - 10	Z7.280.7027.0	20
Busbar	9813 M SN 10X3 1000MM	98.290.1000.0	1

### WKIF 2.5 NTM-D-SL

- Installation multi-tier terminal with tension spring connection for mounting on TS 35
- Nominal cross section 2.5 mm<sup>2</sup>

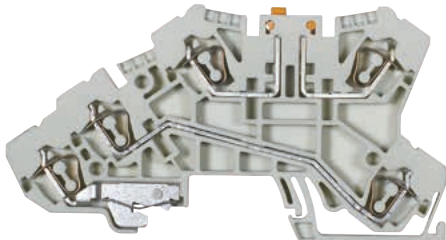

Description	Type	Part No.	Std. Pack
Installation terminal with cutting knife	WKIF 2,5 NTM-D-SL	56.703.8653.0	50
Installation terminal, same construction without cutting knife	WKIF 2,5 NTM-D-SL	on request	50

#### GENERAL DATA

Width / length / height, incl. TS 7.5	5 mm / 95 mm / 51.2 mm
Wire strip length	11 mm
Approvals	

TECHNICAL DATA	IEC	UL	CSA	EX
	EN 60 947-7-1			
Cross section fine-stranded	0.14-2.5 mm <sup>2</sup>			
Cross section solid/stranded	0.14-4 mm <sup>2</sup>			
Cross-section, AWG				
Rated current	16 A			
Rated voltage	400 V			
Rated impulse voltage	6 kV			
Pollution degree	3			

ACCESSORIES	Type	Part No.	Std. Pack
End plate	APIF 2,5 TM	07.312.8053.0	10
Jumper bar	2-pole IVBWK 2,5 - 2	Z7.280.6227.0	10
	3-pole IVBWK 2,5 - 3	Z7.280.6327.0	10
	4-pole IVBWK 2,5 - 4	Z7.280.6427.0	10
	5-pole IVBWK 2,5 - 5	Z7.280.6527.0	10
	10-pole IVBWK 2,5 - 10	Z7.280.7027.0	20

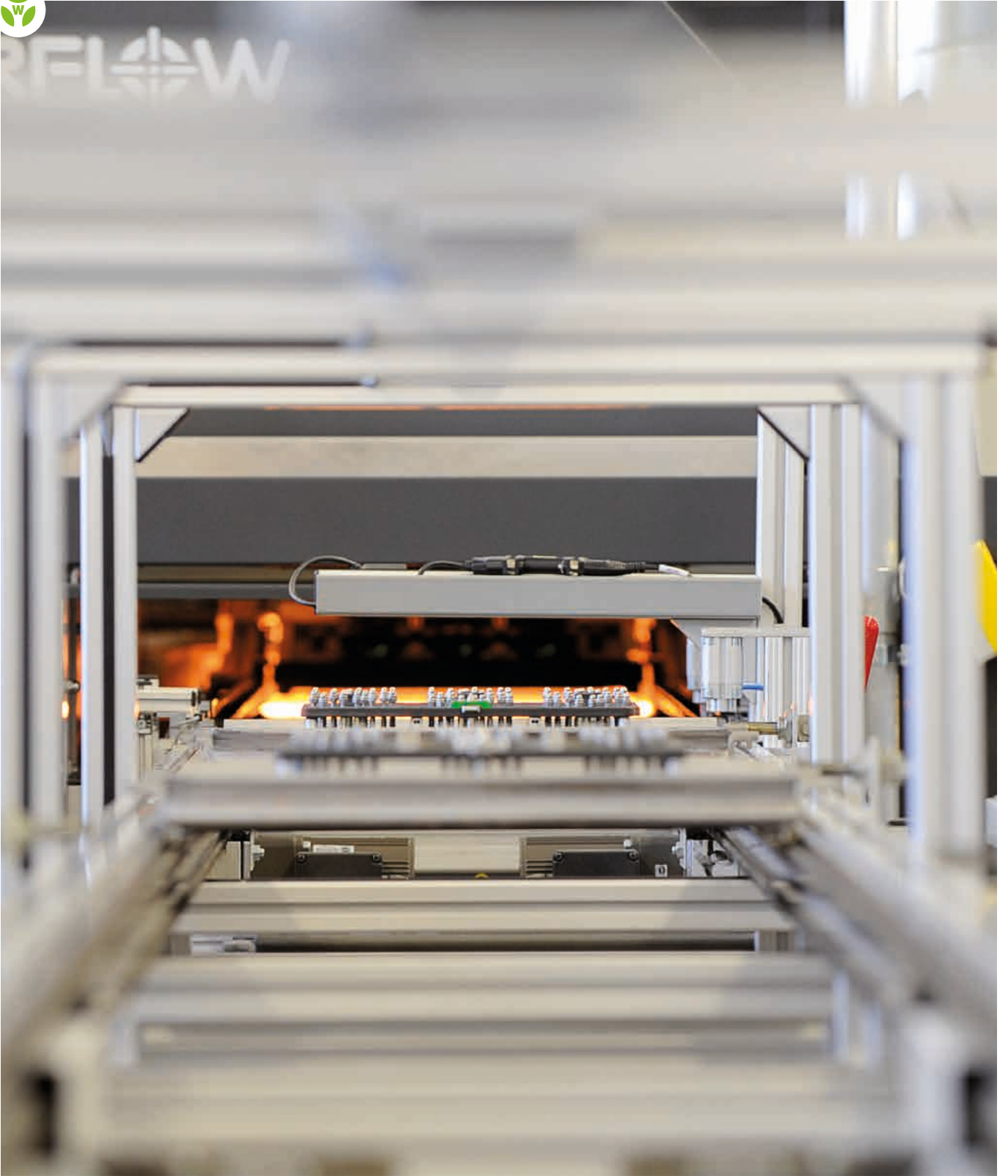



# FASIS WTP

## DIN RAIL TERMINAL BLOCKS WITH **PUSH-IN CONNECTION**

Terminate wires easily, directly and without tools!  
fasis WTP – DIN rail terminal blocks with push-in connection.  
Built according to an effective and comprehensive concept, including compact design and high-performance contact technology, fasis WTP reduces installation time and keeps inventory costs to a minimum.

The portfolio includes feed-through and ground terminals with 2, 3, or 4 locations for connecting wires as well as multi-tier terminals and solutions for initiators and actuators.

fasis WTP has been designed for use in machinery and plant engineering, as well as power distribution for buildings.

Connection cross-sections up to 10 mm<sup>2</sup>  
Rated current of up to 57 A  
Rated voltage of up to 1000 V

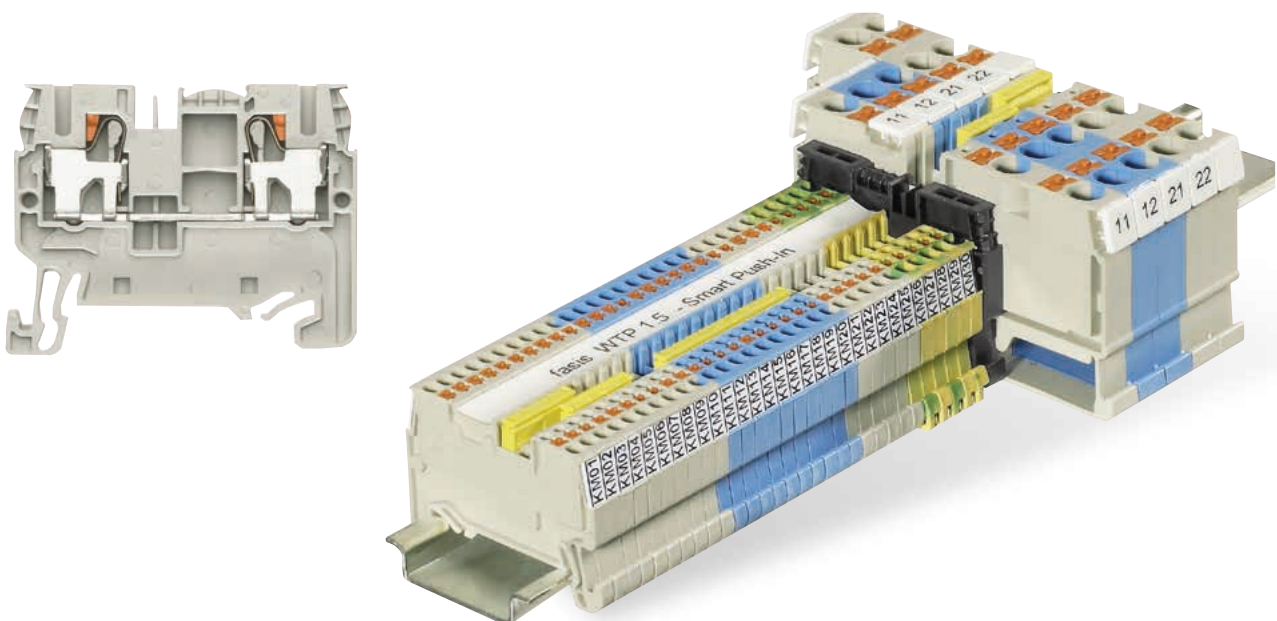





# FASIS WTP

## TERMINALS WITH **PUSH-IN** CONNECTION SAVE TIME AND MONEY

- Connect your control cabinet quickly without losing time
- Save space in the control cabinet
- Reduce your logistics overhead
- Connect your plant safely

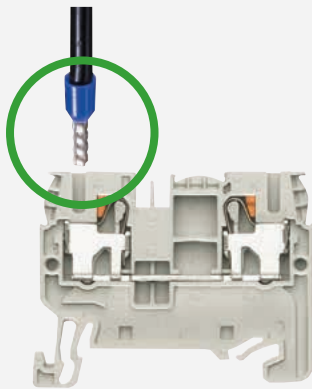
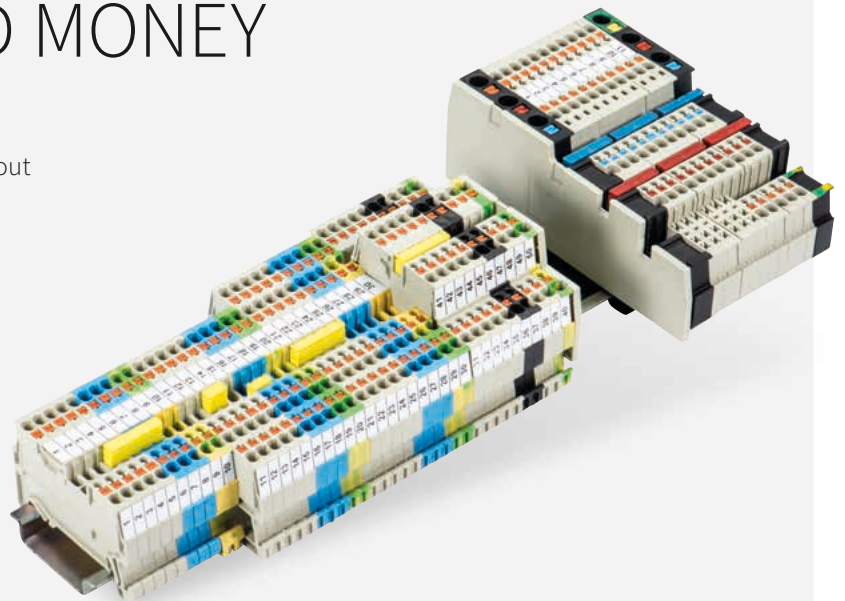

### **SIMPLY PLUG IN WIRES**

- Connect quickly without any tools
- With smart push-in connection
- Connect wires directly

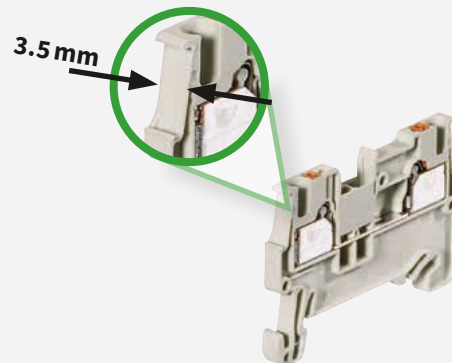

### **EFFICIENT USE OF SPACE IN CONTROL CABINET**

- High packing density
- Assembly width only 3.5 mm

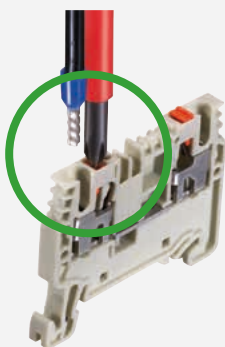

### **SAFE HANDLING**

- With integrated release lever
- No mix-up of wire entry and screwdriver entry points
- No contact with live parts
- Use of Phillips screwdriver also possible

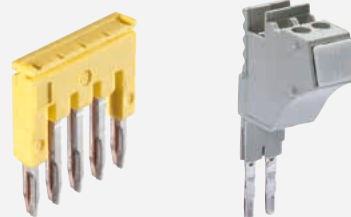

### **PLUG & PLAY – COMPLETING THE CONCEPT**

- Dual jumpering channel
- Plug-in jumper bars
- Plug-in test adapter

# FASIS WTP PORTFOLIO

---

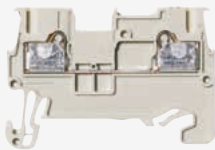

## FASIS WTP 1.5 FOR SIGNAL WIRING

---

### Feed-through and PE terminal blocks

- Efficient use of space in control cabinet

### Multi-tier terminals

- Only 1.75 mm / signal pass!

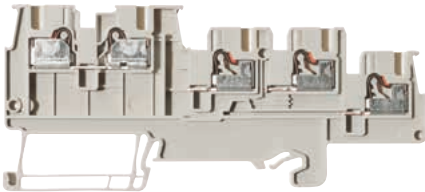

## FASIS WTP 1.5 FOR INITIATOR / ACTUATOR WIRING

---

### Connection solutions for 3-wire and 4-wire sensors and actuators

- Powerful feeder terminal
- Various applications (control cabinet, distributors)
- Efficient use of space in control cabinet

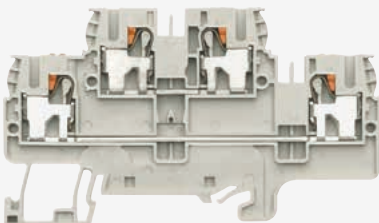

## FASIS WTP 2.5/4 FOR UNIVERSAL APPLICATIONS

---

### Feed-through and PE terminal blocks

### Multi-tier terminals

- Cost-saving for warehousing & logistics
- 2.5 and 4 mm<sup>2</sup> in a terminal with assembly width of only 5 mm
- Uniform and universal accessories

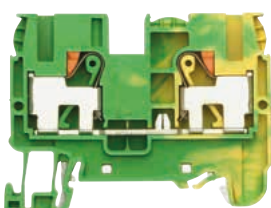

## FASIS WTP 6/10 FOR ENERGY DISTRIBUTION

---

### Feed-through and PE terminal blocks

### Multi-conductor terminals

- Powerful – up to 10 mm<sup>2</sup> and 57 A
- Assembly width of only 8 mm

# FEED-THROUGH TERMINALS WITH PUSH-IN CONNECTION

## WTP 1,5

- Feed-through terminal with push-in connection for mounting on mounting rail (MR) 35
- Nominal cross-section 1.5 mm<sup>2</sup>
- Assembly width of 3.5 mm

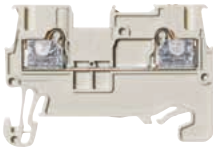

Description	Type	Part No.	Std. Pack	
Feed-through terminal	gray WTP 1,5	56.202.0055.0	100	
Feed-through terminal	blue WTP 1,5 BLAU	56.202.0055.6	100	
GENERAL DATA				
Width / length / height, incl. MR 7.5	3.5 mm / 46 mm / 32 mm			
Wire strip length	8 mm			
Certificates / Approvals				
TECHNICAL DATA	IEC	UL	CSA	Ex
Cross-section fine-stranded	EN 60 947-7-1	Pending	Pending	Pending
Cross-section solid/stranded	0.14 - 1.5 mm <sup>2</sup>			
Cross-section, AWG	26-14		26-14	
Rated current	17.5 A	15 A	15 A	
Rated voltage	500 V	300 V	300 V	
Rated impulse voltage	6 kV			
Pollution degree	3			
ACCESSORIES	Type	Part No.	Std. Pack	
End plate	AP WTP 1,5	07.313.4455.0	10	
Partition	TW WTP 1,5	07.313.4955.0	10	

## WTP 1,5 D1/2

- Duo feed-through terminal with push-in connection for mounting on MR 35
- Nominal cross-section 1.5 mm<sup>2</sup>
- Assembly width of 3.5 mm

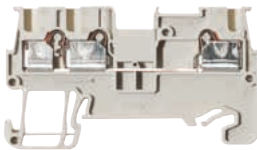

Description	Type	Part No.	Std. Pack	
Feed-through terminal	gray WTP 1,5 D1/2	56.202.5055.0	100	
Feed-through terminal	blue WTP 1,5 D1/2 BLAU	56.202.5055.6	100	
GENERAL DATA				
Width / length / height, incl. MR 7.5	3.5 mm / 55 mm / 32 mm			
Wire strip length	8 mm			
Certificates / Approvals				
TECHNICAL DATA	IEC	UL	CSA	Ex
Cross-section fine-stranded	EN 60 947-7-1	Pending	Pending	Pending
Cross-section solid/stranded	0.14 - 1.5 mm <sup>2</sup>			
Cross-section, AWG	26-14		26-14	
Rated current	17.5 A	15 A	15 A	
Rated voltage	500 V	300 V	300 V	
Rated impulse voltage	6 kV			
Pollution degree	3			
ACCESSORIES	Type	Part No.	Std. Pack	
End plate	AP WTP 1,5 D1/2	07.313.4555.0	10	
Partition	TW WTP 1,5 D/E	07.313.5555.0	10	

## WTP 1,5 D2/2

- Duo feed-through terminal with push-in connection for mounting on MR 35
- Nominal cross-section 1.5 mm<sup>2</sup>
- Assembly width of 3.5 mm

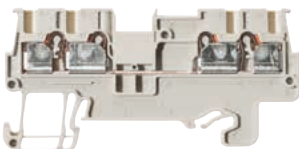

Description	Type	Part No.	Std. Pack	
Feed-through terminal	gray WTP 1,5 D2/2	56.202.5155.0	100	
Feed-through terminal	blue WTP 1,5 D2/2 BLAU	56.202.5155.6	100	
GENERAL DATA				
Width / length / height, incl. MR 7.5	3.5 mm / 64 mm / 32 mm			
Wire strip length	8 mm			
Certificates / Approvals				
TECHNICAL DATA	IEC	UL	CSA	Ex
Cross-section fine-stranded	EN 60 947-7-1	Pending	Pending	Pending
Cross-section solid/stranded	0.14 - 1.5 mm <sup>2</sup>			
Cross-section, AWG	26-14		26-14	
Rated current	17.5 A	15 A	15 A	
Rated voltage	500 V	300 V	300 V	
Rated impulse voltage	6 kV			
Pollution degree	3			
ACCESSORIES	Type	Part No.	Std. Pack	
End plate	AP WTP 1,5 D2/2	07.313.4655.0	10	
Partition	TW WTP 1,5 D/E	07.313.5555.0	10	

## ACCESSORIES FOR FASIS WTP 1.5...

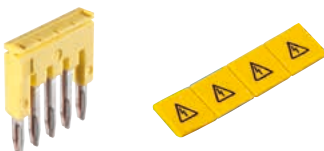

ACCESSORIES	Type	Part No.	Std. Pack	
Jumper bar	2-pole	IVB WTP 1,5-2	Z7.284.7027.0	10
	3-pole	IVB WTP 1,5-3	Z7.284.7127.0	10
	4-pole	IVB WTP 1,5-4	Z7.284.7227.0	10
	5-pole	IVB WTP 1,5-5	Z7.284.7327.0	10
	10-pole	IVB WTP 1,5-10	Z7.284.7427.0	10
Warning cover	AD WTP 1,5	04.344.2655.0	10	
Screwdriver	DIN 5264 B 0,4 X 2,5	06.502.4300.0	5	
Marking accessories, see P. 164				

# GROUND TERMINALS WITH PUSH-IN CONNECTION



## WTP 1,5 PE

- Ground terminal with push-in connection for mounting on MR 35
- Nominal cross-section 1.5 mm<sup>2</sup>
- Assembly width of 3.5 mm



Description	Type	Part No.	Std. Pack	
Ground terminal	green/yellow	WTP 1,5 PE	56.202.9055.0	100
<b>GENERAL DATA</b>				
Width / length / height, incl. MR 7.5	3.5 mm / 46 mm / 32 mm			
Wire strip length	8 mm			
Certificates / Approvals				
TECHNICAL DATA	IEC	UL	CSA	Ⓔ
	EN 60 947-7-2	Pending	Pending	Pending
Cross-section fine-stranded	0.14 – 1.5 mm <sup>2</sup>			
Cross-section solid/stranded	0.14 – 2.5 mm <sup>2</sup>			
Cross-section, AWG	26–14		26–14	
Rated voltage	500 V	300 V	300 V	
Rated impulse voltage	6 kV			
Pollution degree	3			
ACCESSORIES	Type	Part No.	Std. Pack	
End plate	gray	AP WTP 1,5	07.313.4455.0	10
Partition	gray	TW WTP 1,5	07.313.4955.0	10

## WTP 1,5 D1/2 PE

- Duo ground terminal with push-in connection for mounting on MR 35
- Nominal cross-section 1.5 mm<sup>2</sup>
- Assembly width of 3.5 mm

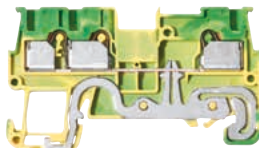

Description	Type	Part No.	Std. Pack	
Ground terminal	green/yellow	WTP 1,5 D1/2 PE	56.202.9355.0	100
<b>GENERAL DATA</b>				
Width / length / height, incl. MR 7.5	3.5 mm / 55 mm / 32 mm			
Wire strip length	8 mm			
Certificates / Approvals				
TECHNICAL DATA	IEC	UL	CSA	Ⓔ
	EN 60 947-7-2	Pending	Pending	Pending
Cross-section fine-stranded	0.14 – 1.5 mm <sup>2</sup>			
Cross-section solid/stranded	0.14 – 2.5 mm <sup>2</sup>			
Cross-section, AWG	26–14		26–14	
Rated voltage	500 V	300 V	300 V	
Rated impulse voltage	6 kV			
Pollution degree	3			
ACCESSORIES	Type	Part No.	Std. Pack	
End plate		AP WTP 1,5 D1/2	07.313.4555.0	10
Partition		TW WTP 1,5 D/E	07.313.5555.0	10

## WTP 1,5 D2/2 PE

- Duo ground terminal with push-in connection for mounting on MR 35
- Nominal cross-section 1.5 mm<sup>2</sup>
- Assembly width of 3.5 mm

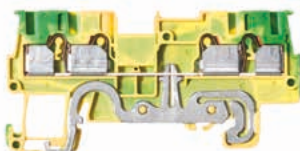

Description	Type	Part No.	Std. Pack	
Ground terminal	green/yellow	WTP 1,5 D2/2 PE	56.202.9155.0	100
<b>GENERAL DATA</b>				
Width / length / height, incl. MR 7.5	3.5 mm / 64 mm / 32 mm			
Wire strip length	8 mm			
Certificates / Approvals				
TECHNICAL DATA	IEC	UL	CSA	Ⓔ
	EN 60 947-7-2	Pending	Pending	Pending
Cross-section fine-stranded	0.14 – 1.5 mm <sup>2</sup>			
Cross-section solid/stranded	0.14 – 2.5 mm <sup>2</sup>			
Cross-section, AWG	26–14		26–14	
Rated voltage	500 V	300 V	300 V	
Rated impulse voltage	6 kV			
Pollution degree	3			
ACCESSORIES	Type	Part No.	Std. Pack	
End plate		AP WTP 1,5 D2/2	07.313.4655.0	10
Partition		TW WTP 1,5 D/E	07.313.5555.0	10

## ACCESSORIES FOR FASIS WTP 1.5... PE



ACCESSORIES	Type	Part No.	Std. Pack
Warning cover	AD WTP 1,5	04.344.2655.0	10
Screwdriver	DIN 5264 B 0,4 X 2,5	06.502.4300.0	5
Marking accessories, see P. 164			

# MULTI-TIER TERMINALS WITH PUSH-IN CONNECTION

## WTP 1,5 E

- Multi-tier terminal with push-in connection for mounting on MR 35
- Nominal cross-section 1.5 mm<sup>2</sup>
- Assembly width of 3.5 mm

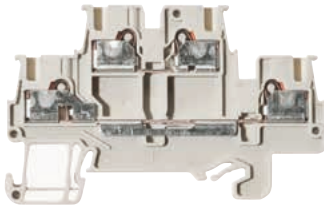

Description	Type	Part No.	Std. Pack
Multi-tier terminal	gray WTP 1,5 E	56.202.7055.0	100
<b>GENERAL DATA</b>			
Width / length / height, incl. MR 7.5	3.5 mm / 67 mm / 42 mm		
Wire strip length	8 mm		
Certificates / Approvals			
<b>TECHNICAL DATA</b>			
	<b>IEC</b>	<b>UL</b>	<b>CSA</b>
	EN 60 947-7-1	Pending	Pending
	Pending		
Cross-section fine-stranded	0.14 – 1.5 mm <sup>2</sup>		
Cross-section solid/stranded	0.14 – 2.5 mm <sup>2</sup>		
Cross-section, AWG	26–14		26–14
Rated current	15 A	15 A	15 A
Rated voltage	500 V	300 V	300 V
Rated impulse voltage	6 kV		
Pollution degree	3		
<b>ACCESSORIES</b>			
	<b>Type</b>	<b>Part No.</b>	<b>Std. Pack</b>
End plate	AP WTP 1,5 E	07.313.4755.0	10
Partition	TW WTP 1,5 D/E	07.313.5555.0	10
Jumper bar	2-pole IVB WTP 1,5-2	Z7.284.7027.0	10
	3-pole IVB WTP 1,5-3	Z7.284.7127.0	10
	4-pole IVB WTP 1,5-4	Z7.284.7227.0	10
	5-pole IVB WTP 1,5-5	Z7.284.7327.0	10
	10-pole IVB WTP 1,5-10	Z7.284.7427.0	10
Warning cover	AD WTP 1,5	04.344.2655.0	10

## WTP 1,5 E VB

- Multi-tier terminal, connected vertically, with push-in connection for mounting on MR 35
- Nominal cross-section 1.5 mm<sup>2</sup>
- Assembly width of 3.5 mm

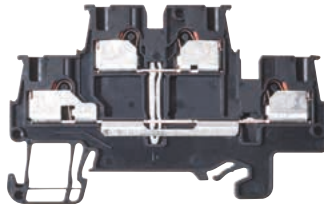

Description	Type	Part No.	Std. Pack
Multi-tier terminal	black WTP 1,5 EVB	56.202.6955.1	100
<b>GENERAL DATA</b>			
Width / length / height, incl. MR 7.5	3.5 mm / 67 mm / 42 mm		
Wire strip length	8 mm		
Certificates / Approvals			
<b>TECHNICAL DATA</b>			
	<b>IEC</b>	<b>UL</b>	<b>CSA</b>
	EN 60 947-7-1	Pending	Pending
	Pending		
Cross-section fine-stranded	0.14 – 1.5 mm <sup>2</sup>		
Cross-section solid/stranded	0.14 – 2.5 mm <sup>2</sup>		
Cross-section, AWG	26–14		26–14
Rated current	15 A	15 A	15 A
Rated voltage	500 V	300 V	300 V
Rated impulse voltage	6 kV		
Pollution degree	3		
<b>ACCESSORIES</b>			
	<b>Type</b>	<b>Part No.</b>	<b>Std. Pack</b>
End plate	AP WTP 1,5 E	07.313.4755.0	10
Partition	TW WTP 1,5 D/E	07.313.5555.0	10
Jumper bar	2-pole IVB WTP 1,5-2	Z7.284.7027.0	10
	3-pole IVB WTP 1,5-3	Z7.284.7127.0	10
	4-pole IVB WTP 1,5-4	Z7.284.7227.0	10
	5-pole IVB WTP 1,5-5	Z7.284.7327.0	10
	10-pole IVB WTP 1,5-10	Z7.284.7427.0	10
Warning cover	AD WTP 1,5	04.344.2655.0	10

## WTP 1,5 E PE

- Multi-tier ground terminal with push-in connection for mounting on MR 35
- Nominal cross-section 1.5 mm<sup>2</sup>
- Assembly width of 3.5 mm

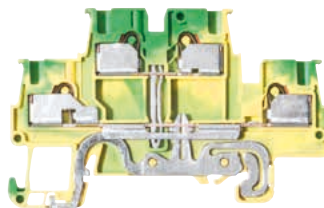

Description	Type	Part No.	Std. Pack
Multi-tier ground terminal	green/yellow WTP 1,5 EPE	56.202.9255.0	100
<b>GENERAL DATA</b>			
Width / length / height, incl. MR 7.5	3.5 mm / 67 mm / 42 mm		
Wire strip length	8 mm		
Certificates / Approvals			
<b>TECHNICAL DATA</b>			
	<b>IEC</b>	<b>UL</b>	<b>CSA</b>
	EN 60 947-7-2	Pending	Pending
	Pending		
Cross-section fine-stranded	0.14 – 1.5 mm <sup>2</sup>		
Cross-section solid/stranded	0.14 – 2.5 mm <sup>2</sup>		
Cross-section, AWG	26–14		26–14
Rated voltage	500 V	300 V	300 V
Rated impulse voltage	6 kV		
Pollution degree	3		
<b>ACCESSORIES</b>			
	<b>Type</b>	<b>Part No.</b>	<b>Std. Pack</b>
End plate	AP WTP 1,5 E	07.313.4755.0	10
Partition	TW WTP 1,5 D/E	07.313.5555.0	10
Warning cover	AD WTP 1,5	04.344.2655.0	10



# INITIATOR TERMINALS WITH PUSH-IN CONNECTION



## WTP 1,5 I/O -3

- Three-wire initiator/actuator terminal with push-in connection for mounting on MR 35
- Nominal cross-section 1.5 mm<sup>2</sup>
- Assembly width of 3.5 mm

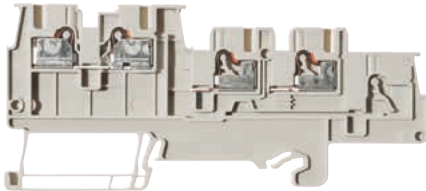

Description	Type	Part No.	Std. Pack	
Initiator/actuator terminal	gray WTP 1,5 I/O-3	56.202.8055.0	50	
Initiator/actuator terminal with indicator		Upon request		
GENERAL DATA				
Width / length / height, incl. MR 7.5	3.5 mm / 94 mm / 42 mm			
Wire strip length	8 mm			
Certificates / Approvals				
TECHNICAL DATA	IEC	UL	CSA	Ⓔ
Cross-section fine-stranded	EN 60 947-7-1	Pending	Pending	Pending
Cross-section solid/stranded	0.14 - 1.5 mm <sup>2</sup>			
Cross-section, AWG	26-14		26-14	
Rated current	13.5 A			
Rated voltage	250 V			
Rated impulse voltage	4 kV			
Pollution degree	3			
ACCESSORIES	Type	Part No.	Std. Pack	
End plate	AP WTP 1,5 I/O	07.313.4855.0	10	

## WTP 1,5 I/O -4...

- Four-wire initiator/actuator terminal with push-in connection for mounting on MR 35
- Nominal cross-section 1.5 mm<sup>2</sup>
- Assembly width of 3.5 mm

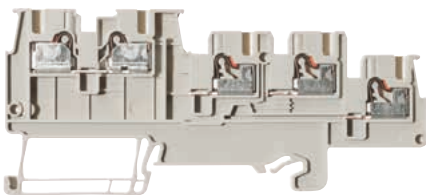

Description	Type	Part No.	Std. Pack	
Initiator/actuator terminal	gray WTP 1,5 I/O-4	56.202.8155.0	100	
Initiator/actuator terminal	gray WTP 1,5 I/O-4 PE	56.202.9555.0	100	
Initiator/actuator terminal with indicator		Upon request		
GENERAL DATA				
Width / length / height, incl. MR 7.5	3.5 mm / 94 mm / 42 mm			
Wire strip length	8 mm			
Certificates / Approvals				
TECHNICAL DATA	IEC	UL	CSA	Ⓔ
Cross-section fine-stranded	EN 60 947-7-1	Pending	Pending	Pending
Cross-section solid/stranded	0.14 - 1.5 mm <sup>2</sup>			
Cross-section, AWG	26-14		26-14	
Rated current	13.5 A			
Rated voltage	250 V			
Rated impulse voltage	4 kV			
Pollution degree	3			
ACCESSORIES	Type	Part No.	Std. Pack	
End plate	AP WTP 1,5 I/O	07.313.4855.0	10	

## WTP 1,5 I/O -IN...

- Feeder terminal for initiator/actuator terminal with push-in connection for mounting on MR 35
- Nominal cross-section 2.5 mm<sup>2</sup>
- Assembly width of 7 mm

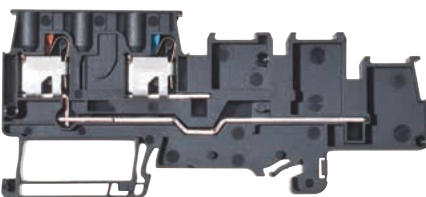

Description	Type	Part No.	Std. Pack	
Feeder terminal	black WTP 1,5 I/O-IN	56.202.8255.0	20	
Feeder terminal	black WTP 1,5 I/O-IN PE	56.202.9655.0	20	
GENERAL DATA				
Width / length / height, incl. MR 7.5	7 mm / 94 mm / 42 mm			
Wire strip length	8 mm			
Certificates / Approvals				
TECHNICAL DATA	IEC	UL	CSA	Ⓔ
Cross-section fine-stranded	EN 60 947-7-1/-2	Pending	Pending	Pending
Cross-section solid/stranded	0.2 - 4 mm <sup>2</sup>			
Cross-section, AWG	24-12		24-12	
Rated current	17.5 A			
Rated voltage	250 V			
Rated impulse voltage	4 kV			
Pollution degree	3			
ACCESSORIES	Type	Part No.	Std. Pack	
End plate	AP WTP 1,5 I/O	07.313.4855.0	10	

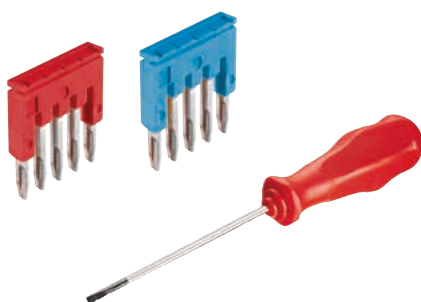

ACCESSORIES FOR WTP 1.5 I/O...	Type	Part No.	Std. Pack	
Jumper bar, red	2-pole	IVB WTP 1,5-2 rot	Z7.284.7027.5	10
	3-pole	IVB WTP 1,5-3 rot	Z7.284.7127.5	10
	4-pole	IVB WTP 1,5-4 rot	Z7.284.7227.5	10
	5-pole	IVB WTP 1,5-5 rot	Z7.284.7327.5	10
	10-pole	IVB WTP 1,5-10 rot	Z7.284.7427.5	10
Jumper bar, blue	2-pole	IVB WTP 1,5-2 blau	Z7.284.7027.6	10
	3-pole	IVB WTP 1,5-3 blau	Z7.284.7127.6	10
	4-pole	IVB WTP 1,5-4 blau	Z7.284.7227.6	10
	5-pole	IVB WTP 1,5-5 blau	Z7.284.7327.6	10
	10-pole	IVB WTP 1,5-10 blau	Z7.284.7427.6	10
Screwdriver	DIN 5264 B 0,4 X 2,5	06.502.4300.0	5	
Marking accessories, see P. 164				

# FEED-THROUGH BLOCKS WITH PUSH-IN CONNECTION

## WTP 2,5/4

- Feed-through block with push-in connection for mounting on TS 35
- Nominal cross section 4 mm<sup>2</sup>

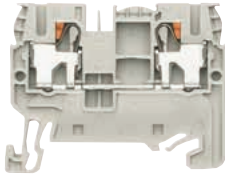

\* When cross connector IVB WKF 2,5-... is used, the rated voltage must be reduced to 630 V.

Description	Type	Part No.	Std. Pack
Feed-through block	gray WTP 2,5/4	56.203.0055.0	100
Feed-through block	blue WTP 2,5/4 BLAU	56.203.0055.6	100
GENERAL DATA			
Width / length / height, incl. TS 7.5	5 mm / 47 mm / 38 mm		
Wire strip length	11 mm		
Approvals			
TECHNICAL DATA			
	IEC	UL	CSA
	EN 60 947-7-1		
Cross section fine-stranded	0.2 – 4 mm <sup>2</sup>		
Cross section solid/stranded	0.2 – 4 mm <sup>2</sup>		
Cross section, AWG		24 – 12	22 – 12
Rated current (UL field/factory wiring)	30 A	20 A/30 A	20 A
Rated voltage	800 V*	600 V	600 V
Rated impulse voltage	8 kV		
Pollution degree	3		
ACCESSORIES			
	Type	Part No.	Std. Pack
End plate	gray APFN 2,5	07.312.6755.0	10
Partition	gray TWFN 2,5	07.312.6855.0	10

## WTP 2,5/4 D1/2

- Duo feed-through block with push-in connection for mounting on TS 35
- Nominal cross section 4 mm<sup>2</sup>

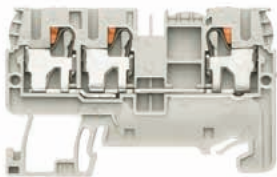

\* When cross connector IVB WKF 2,5-... is used, the rated voltage must be reduced to 630 V.

Description	Type	Part No.	Std. Pack
Feed-through block	gray WTP 2,5/4 D1/2	56.203.5055.0	100
Feed-through block	blue WTP 2,5/4 D1/2 BLAU	56.203.5055.6	100
GENERAL DATA			
Width / length / height, incl. TS 7.5	5 mm / 60 mm / 38 mm		
Wire strip length	11 mm		
Approvals			
TECHNICAL DATA			
	IEC	UL	CSA
	EN 60 947-7-1		
Cross section fine-stranded	0.2 – 4 mm <sup>2</sup>		
Cross section solid/stranded	0.2 – 4 mm <sup>2</sup>		
Cross section, AWG		24 – 12	22 – 12
Rated current (UL field/factory wiring)	30 A	20 A/30 A	20 A
Rated voltage	800 V*	600 V	600 V
Rated impulse voltage	8 kV		
Pollution degree	3		
ACCESSORIES			
	Type	Part No.	Std. Pack
End plate	gray APFN 2,5 D1/2	07.312.6955.0	10
Partition	gray TWFN 2,5 D1/2	07.312.7055.0	10

## WTP 2,5/4 D2/2

- Duo feed-through block with push-in connection for mounting on TS 35
- Nominal cross section 4 mm<sup>2</sup>

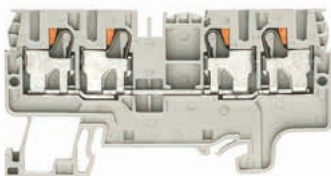

\* When cross connector IVB WKF 2,5-... is used, the rated voltage must be reduced to 630 V.

Description	Type	Part No.	Std. Pack
Feed-through block	gray WTP 2,5/4 D2/2	56.203.5155.0	100
Feed-through block	blue WTP 2,5/4 D2/2 BLAU	56.203.5155.6	100
GENERAL DATA			
Width / length / height, incl. TS 7.5	5 mm / 72 mm / 38 mm		
Wire strip length	11 mm		
Approvals			
TECHNICAL DATA			
	IEC	UL	CSA
	EN 60 947-7-1		
Cross section fine-stranded	0.2 – 4 mm <sup>2</sup>		
Cross section solid/stranded	0.2 – 4 mm <sup>2</sup>		
Cross section, AWG		24 – 12	22 – 12
Rated current (UL field/factory wiring)	30 A	20 A/30 A	20 A
Rated voltage	800 V*	600 V	600 V
Rated impulse voltage	8 kV		
Pollution degree	3		
ACCESSORIES			
	Type	Part No.	Std. Pack
End plate	gray APFN 2,5 D2/2	07.312.7155.0	10
Partition	gray TWFN 2,5 D2/2	07.312.7255.0	10

# GROUND BLOCKS WITH PUSH-IN CONNECTION



## WTP 2,5/4 PE

- Ground block with push-in connection for mounting on TS 35
- Nominal cross section 4 mm<sup>2</sup>

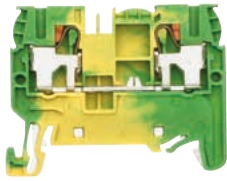

\* When cross connector IVB WKF 2,5-... is used, the rated voltage must be reduced to 630 V.

Description	Type	Part No.	Std. Pack
Ground block	green/yellow	WTP 2,5/4 PE	56.203.9055.0 100
<b>GENERAL DATA</b>			
Width / length / height, incl. TS 7.5	5 mm / 47 mm / 38 mm		
Wire strip length	11 mm		
Approvals			
<b>TECHNICAL DATA</b>			
	IEC	UL	CSA
	EN 60 947-7-2		pending
Cross section fine-stranded	0.2 – 4 mm <sup>2</sup>		
Cross section solid/stranded	0.2 – 4 mm <sup>2</sup>		
Cross section, AWG	24 – 12	22 – 12	
Rated current			
Rated voltage	800 V *	600 V	600 V
Rated impulse voltage	8 kV		
Pollution degree	3		
<b>ACCESSORIES</b>			
	Type	Part No.	Std. Pack
End plate	gray APFN 2,5	07.312.6755.0	10
Partition	gray TWFN 2,5	07.312.6855.0	10

## WTP 2,5/4 D1/2/PE

- Duo ground block with push-in connection for mounting on TS 35
- Nominal cross section 4 mm<sup>2</sup>

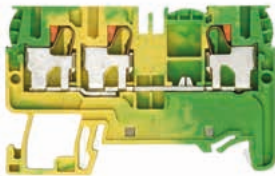

\* When cross connector IVB WKF 2,5-... is used, the rated voltage must be reduced to 630 V.

Description	Type	Part No.	Std. Pack
Ground block	green/yellow	WTP 2,5/4 D1/2/PE	56.203.9355.0 100
<b>GENERAL DATA</b>			
Width / length / height, incl. TS 7.5	5 mm / 60 mm / 38 mm		
Wire strip length	11 mm		
Approvals			
<b>TECHNICAL DATA</b>			
	IEC	UL	CSA
	EN 60 947-7-2		pending
Cross section fine-stranded	0.2 – 4 mm <sup>2</sup>		
Cross section solid/stranded	0.2 – 4 mm <sup>2</sup>		
Cross section, AWG	24 – 12	22 – 12	
Rated current			
Rated voltage	800 V *	600 V	600 V
Rated impulse voltage	8 kV		
Pollution degree	3		
<b>ACCESSORIES</b>			
	Type	Part No.	Std. Pack
End plate	gray APFN 2,5 D1/2	07.312.6955.0	10
Partition	gray TWFN 2,5 D1/2	07.312.7055.0	10

## WTP 2,5/4 D2/2/PE

- Duo ground block with push-in connection for mounting on TS 35
- Nominal cross section 4 mm<sup>2</sup>

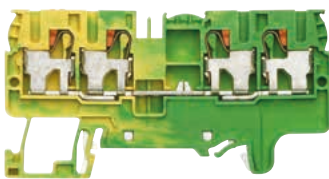

\* When cross connector IVB WKF 2,5-... is used, the rated voltage must be reduced to 630 V.

Description	Type	Part No.	Std. Pack
Ground block	green/yellow	WTP 2,5/4 D2/2/PE	56.203.9155.0 100
<b>GENERAL DATA</b>			
Width / length / height, incl. TS 7.5	5 mm / 72 mm / 38 mm		
Wire strip length	11 mm		
Approvals			
<b>TECHNICAL DATA</b>			
	IEC	UL	CSA
	EN 60 947-7-2		pending
Cross section fine-stranded	0.2 – 4 mm <sup>2</sup>		
Cross section solid/stranded	0.2 – 4 mm <sup>2</sup>		
Cross section, AWG	24 – 12	22 – 12	
Rated current			
Rated voltage	800 V *	600 V	600 V
Rated impulse voltage	8 kV		
Pollution degree	3		
<b>ACCESSORIES</b>			
	Type	Part No.	Std. Pack
End plate	gray APFN 2,5 D2/2	07.312.7155.0	10
Partition	gray TWFN 2,5 D2/2	07.312.7255.0	10

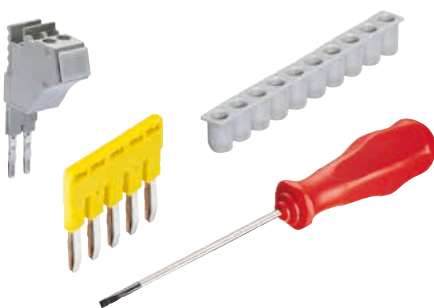

ACCESSORIES FOR WTP 2,5/4...	Type	Part No.	Std. Pack
Cross connector, insulated	2-pole	IVB WKF 2,5 – 2	Z7.280.6227.0 10
	3-pole	IVB WKF 2,5 – 3	Z7.280.6327.0 10
	4-pole	IVB WKF 2,5 – 4	Z7.280.6427.0 10
	5-pole	IVB WKF 2,5 – 5	Z7.280.6527.0 10
	10-pole	IVB WKF 2,5 – 10	Z7.280.7027.0 20
	20-pole	IVB WKF 2,5 – 20	Z7.280.8027.0 20
Wire entry guide	0.13 – 0.2 mm <sup>2</sup>	LELN 2,5/1 WEISS	05.564.3755.0 100
	0.25 – 0.5 mm <sup>2</sup>	LELN 2,5/2 GRAU	05.564.3855.0 100
	0.75 – 1.0 mm <sup>2</sup>	LELN 2,5/3 SCHWARZ	05.564.3955.0 100
Test adapter, modular	PS WKC/F	Z1.299.9753.0	10
Test plug	ST 2/2,3	Z5.553.2921.0	10
Screwdriver, uninsulated	DIN 5264 B 0,6x3,5	06.502.4000.0	5
Screwdriver, uninsulated, MINI	DIN 5264 B 0,6x3,5 M	06.502.5000.0	10
Marking material see page 164			

# MULTI-TIER BLOCKS WITH PUSH-IN CONNECTION

## WTP 2,5/4 E

- Multi-tier block with push-in connection for mounting on TS 35
- Nominal cross section 4 mm<sup>2</sup>

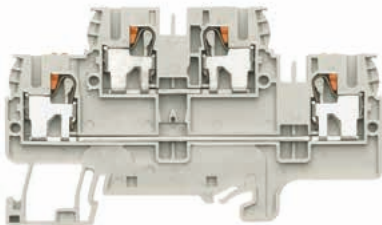

Description	Type	Part No.	Std. Pack
Multi-tier block	gray WTP 2,5/4 E	56.203.7055.0	100
<b>GENERAL DATA</b>			
Width / length / height, incl. TS 7.5	5 mm / 82 mm / 48 mm		
Wire strip length	11 mm		
Approvals			
<b>TECHNICAL DATA</b>			
	<b>IEC</b>	<b>UL</b>	<b>CSA</b>
	EN 60 947-7-1		pending
Cross section fine-stranded	0.2 – 4 mm <sup>2</sup>		
Cross section solid/stranded	0.2 – 4 mm <sup>2</sup>		
Cross section, AWG	24 – 12	22 – 12	
Rated current	24 A	20 A	20 A
Rated voltage	500 V	300 V	300 V
Rated impulse voltage	6 kV		
Pollution degree	3		
<b>ACCESSORIES</b>			
End plate	gray APFN 2,5 E	07.312.7355.0	10
Partition	gray TWFN 2,5 E	07.312.7455.0	10
Marking tag carrier, 2-fold	BT 5/2	04.243.0855.0	100

## WTP 2,5/4 E VB

- Multi-tier block, vertically connected, with push-in connection for mounting on TS 35
- Nominal cross section 4 mm<sup>2</sup>

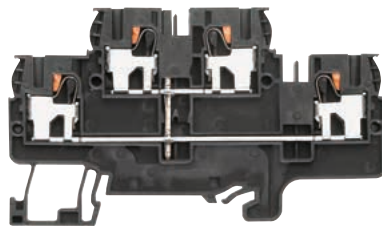

Description	Type	Part No.	Std. Pack
Multi-tier block	black WTP 2,5/4 E VB	56.203.6955.1	100
<b>GENERAL DATA</b>			
Width / length / height, incl. TS 7.5	5 mm / 82 mm / 48 mm		
Wire strip length	11 mm		
Approvals			
<b>TECHNICAL DATA</b>			
	<b>IEC</b>	<b>UL</b>	<b>CSA</b>
	EN 60 947-7-2		pending
Cross section fine-stranded	0.2 – 4 mm <sup>2</sup>		
Cross section solid/stranded	0.2 – 4 mm <sup>2</sup>		
Cross section, AWG	24 – 12	22 – 12	
Rated current	24 A	20 A	20 A
Rated voltage	500 V	300 V	300 V
Rated impulse voltage	6 kV		
Pollution degree	3		
<b>ACCESSORIES</b>			
End plate	gray APFN 2,5 E	07.312.7355.0	10
Partition	gray TWFN 2,5 E	07.312.7455.0	10
Marking tag carrier, 2-fold	BT 5/2	04.243.0855.0	100

## WTP 2,5/4 E PE

- Multi-tier ground block with push-in connection for mounting on TS 35
- Nominal cross section 4 mm<sup>2</sup>

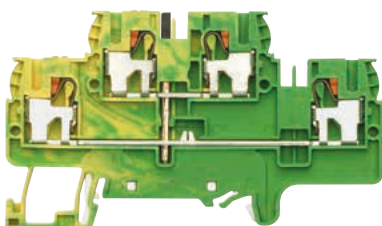

Description	Type	Part No.	Std. Pack
Multi-tier ground block	green/yellow WTP 2,5/4 E PE	56.203.8955.0	100
<b>GENERAL DATA</b>			
Width / length / height, incl. TS 7.5	5 mm / 82 mm / 48 mm		
Wire strip length	11 mm		
Approvals			
<b>TECHNICAL DATA</b>			
	<b>IEC</b>	<b>UL</b>	<b>CSA</b>
	EN 60 947-7-2		pending
Cross section fine-stranded	0.2 – 4 mm <sup>2</sup>		
Cross section solid/stranded	0.2 – 4 mm <sup>2</sup>		
Cross section, AWG	24 – 12	22 – 12	
Rated current			
Rated voltage	500 V	300 V	300 V
Rated impulse voltage	6 kV		
Pollution degree	3		
<b>ACCESSORIES</b>			
End plate	gray APFN 2,5 E	07.312.7355.0	10

## ACCESSORIES FOR FASIS WTP 2,5/4...

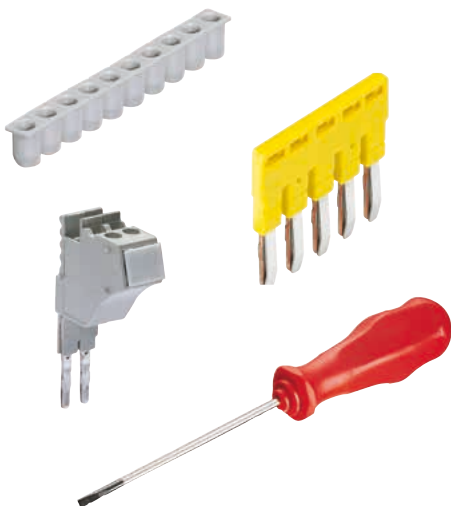

ACCESSORIES	Type	Part No.	Std. Pack	
Cross connector, insulated	2-pole	IVB WKF 2,5-2	Z7.280.6227.0	10
	3-pole	IVB WKF 2,5-3	Z7.280.6327.0	10
	4-pole	IVB WKF 2,5-4	Z7.280.6427.0	10
	5-pole	IVB WKF 2,5-5	Z7.280.6527.0	10
	6-pole	IVB WKF 2,5-6	Z7.280.6627.0	10
	7-pole	IVB WKF 2,5-7	Z7.280.6727.0	20
	8-pole	IVB WKF 2,5-8	Z7.280.6827.0	20
	9-pole	IVB WKF 2,5-9	Z7.280.6927.0	20
	10-pole	IVB WKF 2,5-10	Z7.280.7027.0	20
	20-pole	IVB WKF 2,5-20	Z7.280.8027.0	20
Wire entry guide	0.13-0.2 mm <sup>2</sup>	LELN 2,5/1 WEISS	05.564.3755.0	100
	0.25-0.5 mm <sup>2</sup>	LELN 2,5/2 GRAU	05.564.3855.0	100
	0.75-1.0 mm <sup>2</sup>	LELN 2,5/3 SCHWARZ	05.564.3955.0	100
Test adapter, modular	PS WKC/F	Z1.299.9753.0	10	
Test plug	ST 2/2,3	Z5.553.2921.0	10	
Screwdriver, uninsulated	DIN 5264 B 0,6x3,5	06.502.4000.0	5	
Screwdriver, uninsulated, MINI	DIN 5264 B 0,6x3,5 M	06.502.5000.0	10	
Marking material	see page 164			



# FEED-THROUGH BLOCKS WITH PUSH-IN CONNECTION

## WTP 6/10

- Feed-through block with push-in connection for mounting on TS 35
- Nominal cross section 10 mm<sup>2</sup>

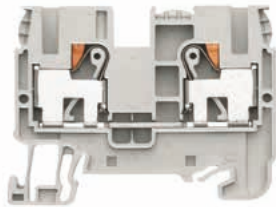

\* When cross connector IVB WKFN 6... is used, the rated voltage must be reduced to 800 V.

Description	Type	Part No.	Std. Pack
Feed-through block	gray WTP 6/10	56.206.0055.0	100
Feed-through block	blue WTP 6/10 BLAU	56.206.0055.6	100
GENERAL DATA			
Width / length / height, incl. TS 7.5	8 mm / 58 mm / 44 mm		
Wire strip length	15 mm		
Approvals			
TECHNICAL DATA			
	IEC	UL	CSA
	EN 60 947-7-1		pending
Cross section fine-stranded	0,2 – 10 mm <sup>2</sup>		
Cross section solid/stranded	0.2 – 10 mm <sup>2</sup>		
Cross section, AWG		10 – 8	12 – 8
Rated current	57 A	41 A	41 A
Rated voltage	1000 V*	600 V	600 V
Rated impulse voltage	8 kV		
Pollution degree	3		
ACCESSORIES			
	Type	Part No.	Std. Pack
End plate	gray AP WTP 6/10	07.313.4155.0	10
Partition	gray TW WTP 6/10	07.313.4255.0	10

## WTP 6/10 D1/2

- Feed-through block with push-in connection for mounting on TS 35
- Nominal cross section 10 mm<sup>2</sup>

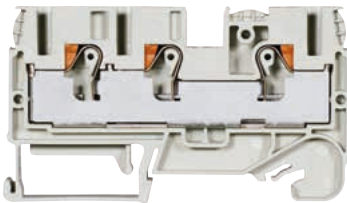

\* When cross connector IVB WKFN 6... is used, the rated voltage must be reduced to 800 V.

Description	Type	Part No.	Std. Pack
Feed-through block	gray WTP 6/10 D1/2	56.206.5055.0	50
Feed-through block	blue WTP 6/10 D1/2 BLAU	56.206.5055.6	50
GENERAL DATA			
Width / length / height, incl. TS 7.5	8 mm / 77 mm / 44 mm		
Wire strip length	15 mm		
Approvals			
TECHNICAL DATA			
	IEC	UL	CSA
	EN 60 947-7-1	pending	pending
Cross section fine-stranded	0,2 – 10 mm <sup>2</sup>		
Cross section solid/stranded	0.2 – 10 mm <sup>2</sup>		
Cross section, AWG			
Rated current	57 A		
Rated voltage	1000 V*		
Rated impulse voltage	8 kV		
Pollution degree	3		
ACCESSORIES			
	Type	Part No.	Std. Pack
End plate	gray AP WTP 6/10 D1/2	07.313.5355.0	10
Partition	gray TW WTP 6/10 Dx/2	07.313.5255.0	10

## WTP 6/10 D2/2

- Feed-through block with push-in connection for mounting on TS 35
- Nominal cross section 10 mm<sup>2</sup>

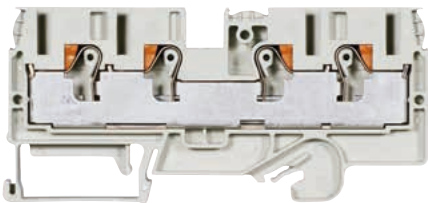

\* When cross connector IVB WKFN 6... is used, the rated voltage must be reduced to 800 V.

Description	Type	Part No.	Std. Pack
Feed-through block	gray WTP 6/10 D2/2	56.206.5155.0	50
Feed-through block	blue WTP 6/10 D2/2 BLAU	56.206.5155.6	50
GENERAL DATA			
Width / length / height, incl. TS 7.5	8 mm / 94 mm / 44 mm		
Wire strip length	15 mm		
Approvals			
TECHNICAL DATA			
	IEC	UL	CSA
	EN 60 947-7-1	pending	pending
Cross section fine-stranded	0,2 – 10 mm <sup>2</sup>		
Cross section solid/stranded	0.2 – 10 mm <sup>2</sup>		
Cross section, AWG			
Rated current	57 A		
Rated voltage	1000 V*		
Rated impulse voltage	8 kV		
Pollution degree	3		
ACCESSORIES			
	Type	Part No.	Std. Pack
End plate	gray AP WTP 6/10 D2/2	07.313.5455.0	10
Partition	gray TW WTP 6/10 Dx/2	07.313.5255.0	10

# GROUND BLOCKS WITH PUSH-IN CONNECTION



## WTP 6/10 PE

- Ground block with push-in connection for mounting on TS 35
- Nominal cross section 10 mm<sup>2</sup>

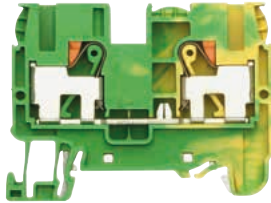

\* When cross connector IVB WKFN 6-... is used, the rated voltage must be reduced to 800 V.

Description	Type	Part No.	Std. Pack
Ground block	green/yellow WTP 6/10 PE	56.206.9055.0	100
<b>GENERAL DATA</b>			
Width / length / height, incl. TS 7.5	8 mm / 58 mm / 44 mm		
Wire strip length	15 mm		
Approvals			
<b>TECHNICAL DATA</b>			
	IEC	UL	CSA
	EN 60 947-7-2		pending
Cross section fine-stranded	0.2 – 10 mm <sup>2</sup>		
Cross section solid/stranded	0.2 – 10 mm <sup>2</sup>		
Cross section, AWG		10 – 8	12 – 8
Rated current			
Rated voltage	1000 V*	600 V	600 V
Rated impulse voltage	8 kV		
Pollution degree	3		
<b>ACCESSORIES</b>			
	Type	Part No.	Std. Pack
End plate	gray AP WTP 6/10	07.313.4155.0	10
Partition	gray TW WTP 6/10	07.313.4255.0	10

## WTP 6/10 D1/2 PE

- Ground block with push-in connection for mounting on TS 35
- Nominal cross section 10 mm<sup>2</sup>

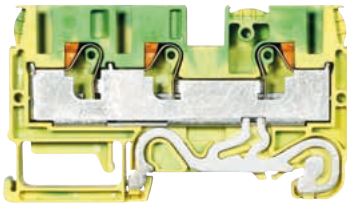

\* When cross connector IVB WKFN 6-... is used, the rated voltage must be reduced to 800 V.

Description	Type	Part No.	Std. Pack
Ground block	green/yellow WTP 6/10 D1/2 PE	56.206.9355.0	50
<b>GENERAL DATA</b>			
Width / length / height, incl. TS 7.5	8 mm / 77 mm / 44 mm		
Wire strip length	15 mm		
Approvals			
<b>TECHNICAL DATA</b>			
	IEC	UL	CSA
	EN 60 947-7-2	pending	pending
Cross section fine-stranded	0.2 – 10 mm <sup>2</sup>		
Cross section solid/stranded	0.2 – 10 mm <sup>2</sup>		
Cross section, AWG			
Rated current			
Rated voltage	1000 V*		
Rated impulse voltage	8 kV		
Pollution degree	3		
<b>ACCESSORIES</b>			
	Type	Part No.	Std. Pack
End plate	gray AP WTP 6/10 D1/2	07.313.5355.0	10
Partition	gray TW WTP 6/10 Dx/2	07.313.5255.0	10

## WTP 6/10 D2/2 PE

- Ground block with push-in connection for mounting on TS 35
- Nominal cross section 10 mm<sup>2</sup>

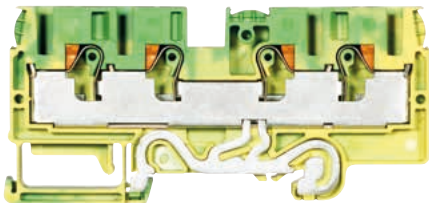

\* When cross connector IVB WKFN 6-... is used, the rated voltage must be reduced to 800 V.

Description	Type	Part No.	Std. Pack
Ground block	green/yellow WTP 6/10 D2/2 PE	56.206.9155.0	50
<b>GENERAL DATA</b>			
Width / length / height, incl. TS 7.5	8 mm / 94 mm / 44 mm		
Wire strip length	15 mm		
Approvals			
<b>TECHNICAL DATA</b>			
	IEC	UL	CSA
	EN 60 947-7-2	pending	pending
Cross section fine-stranded	0.2 – 10 mm <sup>2</sup>		
Cross section solid/stranded	0.2 – 10 mm <sup>2</sup>		
Cross section, AWG			
Rated current			
Rated voltage	1000 V*		
Rated impulse voltage	8 kV		
Pollution degree	3		
<b>ACCESSORIES</b>			
	Type	Part No.	Std. Pack
End plate	gray AP WTP 6/10 D2/2	07.313.5455.0	10
Partition	gray TW WTP 6/10 Dx/2	07.313.5255.0	10

## ACCESSORIES FOR FASIS WTP 6/10....



ACCESSORIES	Type	Part No.	Std. Pack
Cross connector, insulated, I <sub>N</sub> : 41 A	2-pole	IVB WKFN 6-2	Z7.282.5227.0
(57 A when using two cross connectors)	3-pole	IVB WKFN 6-3	Z7.282.5327.0
	4-pole	IVB WKFN 6-4	Z7.282.5427.0
	5-pole	IVB WKFN 6-5	Z7.282.5527.0
Test plug		ST 2/2,3	Z5.553.2921.0
Screwdriver, uninsulated		DIN 5264 B 0,8x4	06.502.4100.0
Marking material see page 164w			

# MULTI-TIER TERMINALS FOR INSTALLATION DISTRIBUTION BOARDS WITH PUSH-IN CONNECTION

## WKIS 2.5 D

- Installation multi-tier terminal with push-in connection for mounting on TS 35
- Nominal cross section 2.5 mm<sup>2</sup>

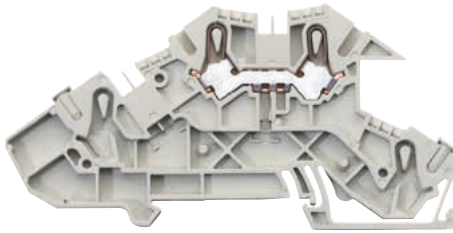

Description	Type	Part No.	Std. Pack
Installation rail terminal blocks	WKIS 2,5 D	56.203.9653.0	50

GENERAL DATA				
Width / length / height, incl. TS 7.5	5 mm / 100 mm / 51.1 mm			
Wire strip length	11 mm			
Approvals				

TECHNICAL DATA	IEC	UL	CSA	EX
	EN 60 947-7-1			
Cross section fine-stranded	0.14-4 mm <sup>2</sup>			
Cross section solid/stranded	0.14-4 mm <sup>2</sup>			
Cross-section, AWG				
Rated current	24 A			
Rated voltage	400 V			
Rated impulse voltage	6 kV			
Pollution degree	3			

ACCESSORIES	Type	Part No.	Std. Pack
End plate	APIS 2,5..	07.313.0253.0	10
Jumper bar	2-pole	IVBWK 2,5 - 2	10
	3-pole	IVBWK 2,5 - 3	10
	10-pole	IVBWK 2,5 - 10	20
	20-pole	IVBWK 2,5 - 20	20
Busbar	9813 M SN 10X3 1000MM	98.290.1000.0	1

## WKIS 2.5 D-D

## WKIS 2.5 N-D

- Installation multi-tier terminal with push-in connection for mounting on TS 35
- Nominal cross section 2.5 mm<sup>2</sup>

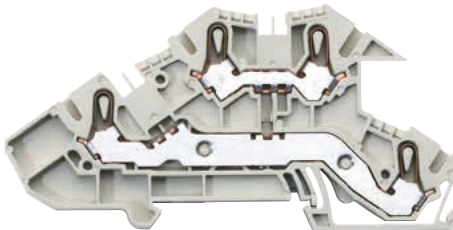

Description	Type	Part No.	Std. Pack
Installation rail terminal blocks	WKIS 2,5 D-D	56.203.9753.0	50
	WKIS 2,5 N-D	56.203.8953.0	50

GENERAL DATA				
Width / length / height, incl. TS 7.5	5 mm / 100 mm / 51.1 mm			
Wire strip length	11 mm			
Approvals				

TECHNICAL DATA	IEC	UL	CSA	EX
	EN 60 947-7-1			
Cross section fine-stranded	0.14-4 mm <sup>2</sup>			
Cross section solid/stranded	0.14-4 mm <sup>2</sup>			
Cross-section, AWG				
Rated current	24 A			
Rated voltage	400 V			
Rated impulse voltage	6 kV			
Pollution degree	3			

ACCESSORIES	Type	Part No.	Std. Pack
End plate	APIS 2,5..	07.313.0253.0	10
Jumper bar	2-pole	IVBWK 2,5 - 2	10
	2-pole	IVBWK 2,5 - 3	10
	10-pole	IVBWK 2,5 - 10	20
	20-pole	IVBWK 2,5 - 20	20
Busbar	9813 M SN 10X3 1000MM	98.290.1000.0	1

## WKIS 2.5 D-D-SL

## WKIS 2.5 N-D-SL

- Installation multi-tier terminal with push-in connection for mounting on TS 35
- Nominal cross section 2.5 mm<sup>2</sup>

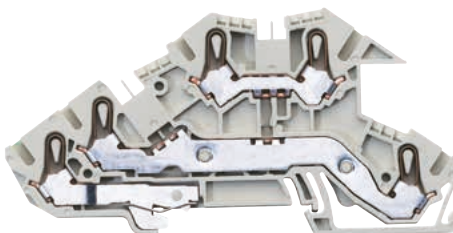

Description	Type	Part No.	Std. Pack
Installation rail terminal blocks	WKIS 2,5 D-D-SL	56.203.9853.0	50
	WKIS 2,5 N-D-SL	56.203.9453.0	50

GENERAL DATA				
Width / length / height, incl. TS 7.5	5 mm / 100 mm / 51.1 mm			
Wire strip length	11 mm			
Approvals				

TECHNICAL DATA	IEC	UL	CSA	EX
	EN 60 947-7-1			
Cross section fine-stranded	0.14-4 mm <sup>2</sup>			
Cross section solid/stranded	0.14-4 mm <sup>2</sup>			
Cross-section, AWG				
Rated current	24 A			
Rated voltage	400 V			
Rated impulse voltage	6 kV			
Pollution degree	3			

ACCESSORIES	Type	Part No.	Std. Pack
End plate	APIS 2,5..	07.313.0253.0	10
Jumper bar	2-pole	IVBWK 2,5 - 2	10
	3-pole	IVBWK 2,5 - 3	10
	10-pole	IVBWK 2,5 - 10	20
	20-pole	IVBWK 2,5 - 20	20
Busbar	9813 M SN 10X3 1000MM	98.290.1000.0	1

### WKIS 2.5 NT-D-SL

- Installation multi-tier terminal with push-in connection for mounting on TS 35
- Nominal cross section 2.5 mm<sup>2</sup>

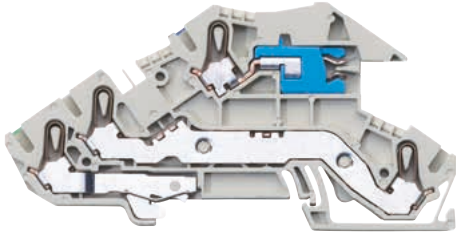

Description	Type	Part No.	Std. Pack
Installation rail terminal blocks	WKIS 2,5 NT-D-SL	56.203.9553.0	50

#### GENERAL DATA

Width / length / height, incl. TS 7.5	5 mm / 100 mm / 51.2 mm
Wire strip length	11 mm
Approvals	

#### TECHNICAL DATA

	IEC	UL	CSA	EX
	EN 60 947-7-1			
Cross section fine-stranded	0.14-4 mm <sup>2</sup>			
Cross section solid/stranded	0.14-4 mm <sup>2</sup>			
Cross-section, AWG				
Rated current	22 A			
Rated voltage	400 V			
Rated impulse voltage	4 kV			
Pollution degree	3			

#### ACCESSORIES

Description	Type	Part No.	Std. Pack
End plate	APIS 2,5..	07.313.0253.0	10
Jumper bar	2-pole IVBWK 2,5 - 2	Z7.280.6227.0	10
	3-pole IVBWK 2,5 - 3	Z7.280.6327.0	10
	10-pole IVBWK 2,5 - 10	Z7.280.7027.0	20
	20-pole IVBWK 2,5 - 20	Z7.280.8027.0	20
Busbar	9813 M SN 10X3 1000MM	98.290.1000.0	1

### WKIS 2.5 NTM-D-SL

- Installation multi-tier terminal with push-in connection for mounting on TS 35
- Nominal cross section 2.5 mm<sup>2</sup>

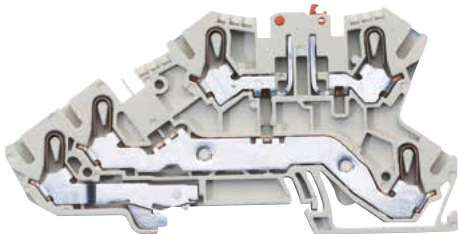

Description	Type	Art.No.	Std. Pack
Installation rail terminal blocks <b>mit Trennmesser</b>	WKIS 2,5 NTM-D-SL	56.203.8653.0	50
Installation rail terminal blocks, <b>baugleich ohne Trennmesser</b>	WKIS 2,5 NTMD-D-SL	56.203.8553.0	50

#### GENERAL DATA

Width / length / height, incl. TS 7.5	5 mm / 100 mm / 50.7 mm
Wire strip length	11 mm
Approvals	

#### TECHNICAL DATA

	IEC	UL	CSA	EX
	EN 60 947-7-1			
Cross section fine-stranded	0.14-4 mm <sup>2</sup>			
Cross section solid/stranded	0.14-4 mm <sup>2</sup>			
Cross-section, AWG				
Rated current	20 A			
Rated voltage	400 V			
Rated impulse voltage	4 kV			
Pollution degree	3			

#### ACCESSORIES

Description	Type	Part No.	Std. Pack
End plate	APIS 2,5 NTM-D-SL	07.313.0353.0	10
Jumper bar	2-pole IVBWK 2,5 - 2	Z7.280.6227.0	10
	3-pole IVBWK 2,5 - 3	Z7.280.6327.0	10
	10-pole IVBWK 2,5 - 10	Z7.280.7027.0	20
	20-pole IVBWK 2,5 - 20	Z7.280.8027.0	20



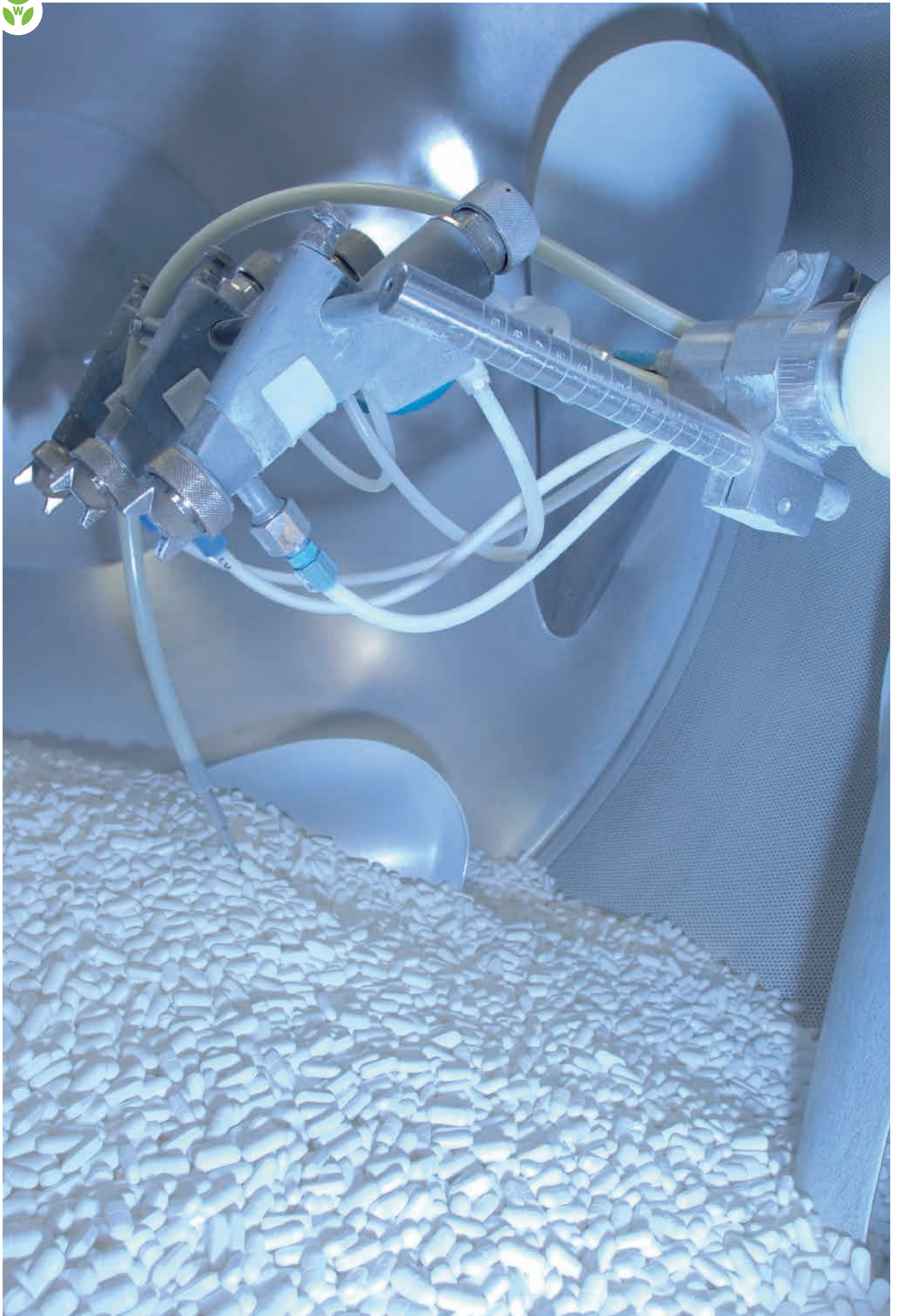



# ACCESSORIES

---

To complement our products, we offer a comprehensive portfolio of accessories and services for terminal blocks.

Wieland offers a variety of product-specific accessories for its terminal blocks, for example covers and isolating plates as well as assembly materials such as mounting rails or tools for working with our products.

Marking solutions such as wieplot and wiemarc for DIN rail terminal blocks and other components in the control cabinet, the planning software wieplan for design of rail assemblies, and our value-add service for rail assemblies, all make working with Wieland DIN rail terminal blocks effortless, and achieve a true added value.

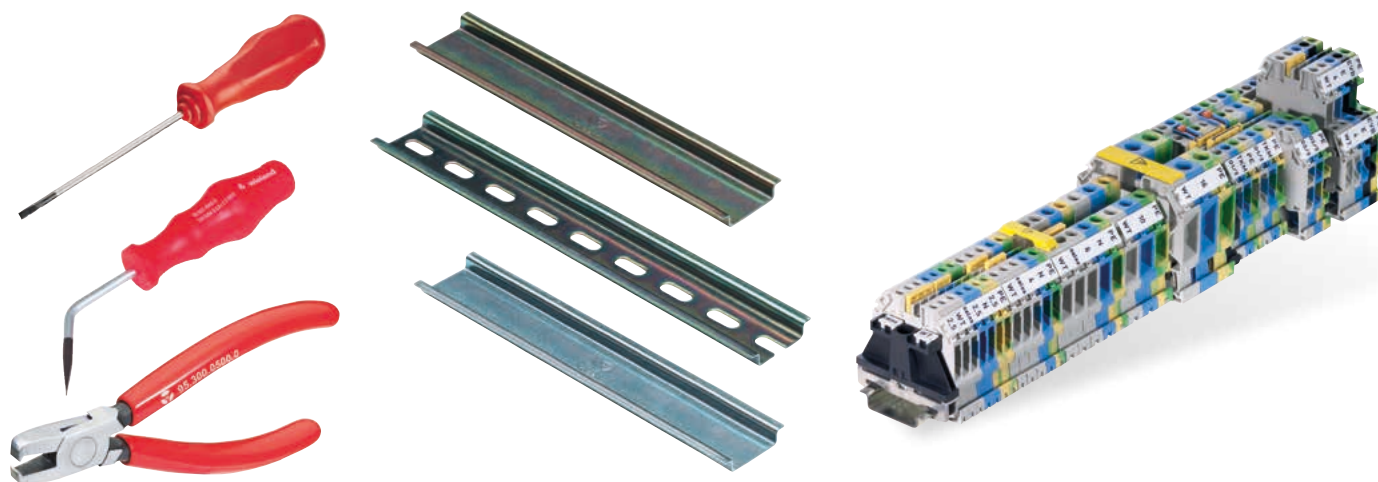



# SHIELDED CABLE TERMINAL BLOCKS, TYPE WST

for trouble-free operation

High interference immunity is an important topic in industrial and process technology. It is one of the key factors affecting the availability of plants. For our selos and fasis terminal block series, we offer WST, a system that enables the cable shield to be connected to the housing earth in a simple, practical manner.

## FEATURES

- Simple mounting - also if upgraded, service and maintenance
- Broad range – up to 32 mm cable diameter
- Top-quality, maintenance-free technology
- Various mounting options

## TOP-QUALITY TECHNOLOGY

- Vibration-proof spring-type technology
- Large-area and low impedance connection
- Highly corrosion resistance
- Durable clamping body from hardened steel

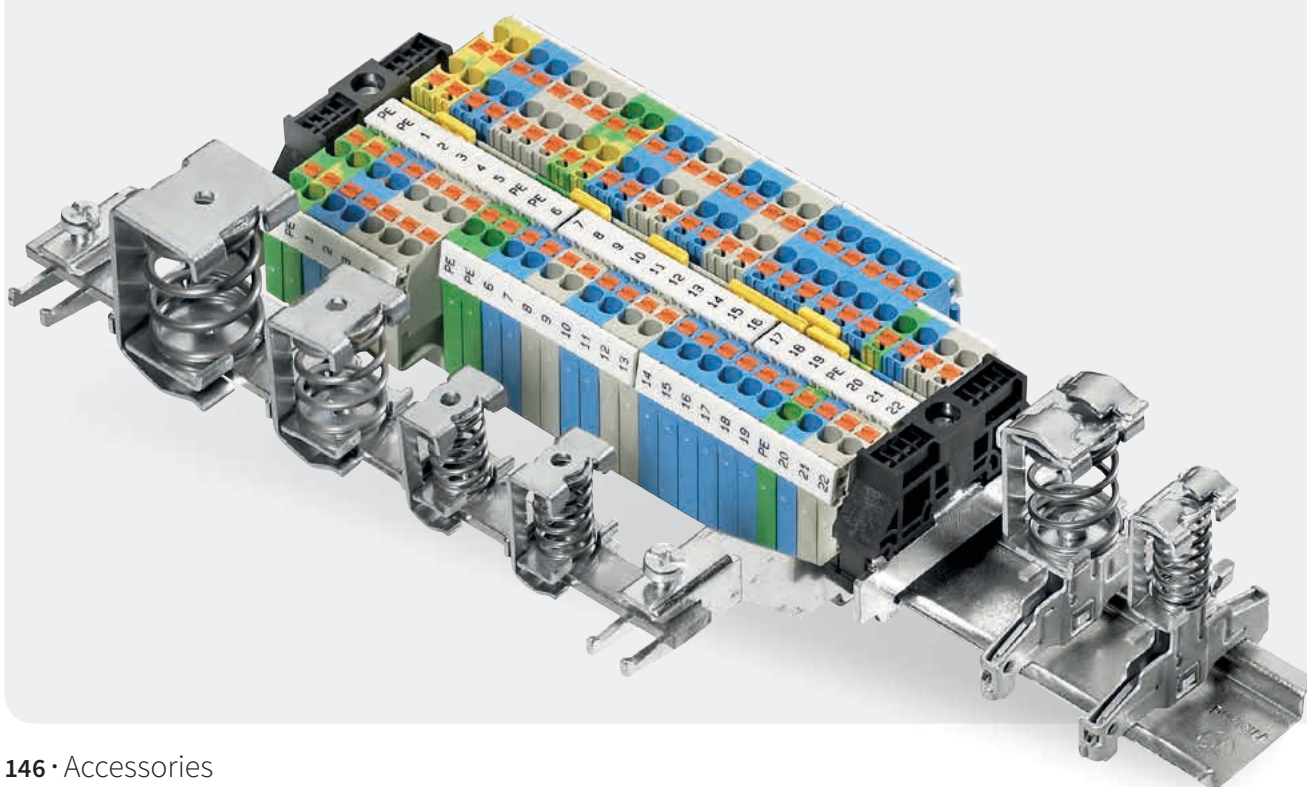

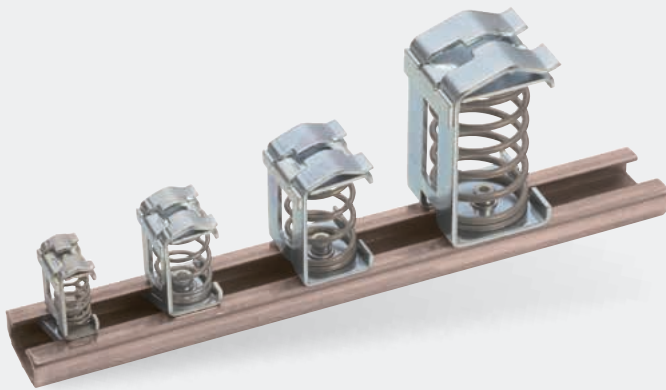

#### VARIOUS APPLICATIONS

- On busbar
- On rail TS 35
- On C-profile
- With screw for mounting plates

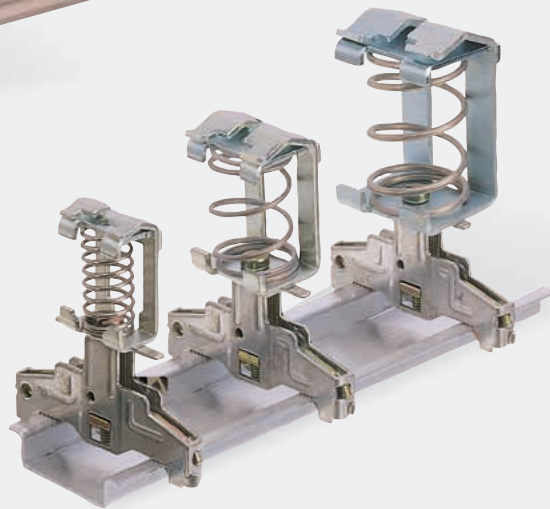

#### VARIOUS ACCESSORIES

- Busbar support for TS 35
- Busbar support for insulated mounting
- Connection terminals



# SHIELDED CABLE TERMINALS

## SHIELDED CABLE TERMINALS FASIS WST ...

- for mounting on busbar 10 x 3 mm

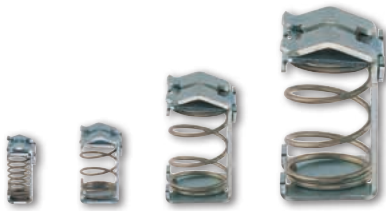

Description	Type	Part No.	Std. Pack	
<b>Shielded cable terminals fasis</b>				
8 mm	WST 8	Z2.803.3010.0	10	
13.5 mm	WST 13,5	Z2.803.3110.0	10	
20 mm	WST 20	Z2.803.3210.0	10	
32 mm	WST 32	Z2.803.3310.0	10	
<b>Technical data</b>				
Width / length / height [mm]	WST 8	WST 13.5	WST 20	WST 32
Connectible cable diameter	3 - 8 mm	4 - 13.5 mm	10 - 20 mm	15 - 32 mm

## SHIELDED CABLE TERMINALS FASIS WST C

- for mounting on C-profile

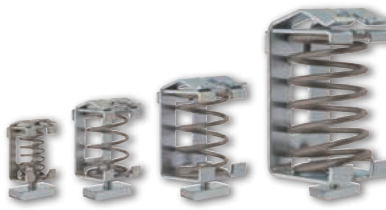

Description	Type	Part No.	Std. Pack	
<b>Shielded cable terminals fasis</b>				
8 mm	WST 8 / C	Z2.803.4010.0	10	
13.5 mm	WST 13,5 / C	Z2.803.4110.0	10	
20 mm	WST 20 / C	Z2.803.4210.0	10	
32 mm	WST 32 / C	Z2.803.4310.0	10	
<b>Technical data</b>				
Width / length / height [mm]	WST 8 / C	WST 13.5 / C	WST 20 / C	WST 32 / C
Connectible cable diameter	3 - 8 mm	4 - 13.5 mm	10 - 20 mm	15 - 32 mm
Mounting screw	M 4	M 4	M 4	M 4
<b>Accessories</b>				
Mounting rail, galvanized steel	L = 2 m	98.400.0000.0	1	
Mounting feet	light gray	Z1.980.0040.0	10	
Ground terminal for mounting rail	9700/10E/1	Z2.302.1321.0	10	

## SHIELDED CABLE TERMINALS FASIS WST D

- for mounting on mounting plate



Description	Type	Part No.	Std. Pack	
<b>Shielded cable terminals fasis</b>				
8 mm	WST 8 / D	Z2.803.5010.0	10	
13.5 mm	WST 13,5 / D	Z2.803.5110.0	10	
20 mm	WST 20 / D	Z2.803.5210.0	10	
32 mm	WST 32 / D	Z2.803.5310.0	10	
<b>Technical data</b>				
Width / length / height [mm]	WST 8 / D	WST 13.5 / D	WST 20 / D	WST 32 / D
Connectible cable diameter	3 - 8 mm	4 - 13.5 mm	10 - 20 mm	15 - 32 mm
Mounting screw	M 4	M 4	M 4	M 4

## SHIELDED CABLE TERMINALS FASIS WST .../T35

- for mounting on TS 35 mounting rail



Description	Type	Part No.	Std. Pack
<b>Shielded cable terminals fasis</b>			
8 mm	WST 8 / TS 35	Z2.803.6010.0	10
13.5 mm	WST 13,5 / TS 35	Z2.803.6110.0	10
20 mm	WST 20 / TS 35	Z2.803.6210.0	10
<b>Technical data</b>			
Width / length / height [mm]	WST 8	WST 13.5	WST 20
Connectible cable diameter	3 - 8 mm	4 - 13.5 mm	10 - 20 mm



# BUSBAR SUPPORT & ACCESSORIES



## BUSBAR SUPPORT



Description	Type	Part No.	Std. Pack
<b>Busbar support</b>			
Busbar support (one-side), tin-plated steel	WE SH 1/35	Z5.515.3310.0	20
Busbar support (two-sided), tin-plated steel	WE SH 2/35	Z5.515.3410.0	20
Busbar support (two-sided), tin-plated steel	WE SH 3/35	Z5.519.0310.0	25
Busbar support (one-side), tin-plated steel	WE SH 4/35	Z5.519.0410.0	25
Busbar support plastic, black	WST H 10x3	Z1.980.0253.0	20

## ACCESSORIES



Description	Type	Part No.	Std. Pack
<b>Accessories</b>			
Ground Terminal, bright	WAK 35/2	30.494.4121.0	50
Ground Terminal, black	WAK 35/2 SW	30.494.4021.1	50
Busbar, Cu tin-plated copper	L = 1 m 9813M SN 10x3	98.290.1000.0	20



# MOUNTING RAILS

## MOUNTING RAIL 35 X 7,5 ACCORDING TO DIN EN 60715

• Length 2 m

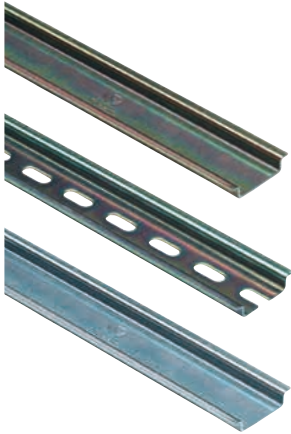

Description	Type	Part No.	Std. Pack
Steel, galv. zinc-plated and dichromated	unslotted	35 x 27 x 7,5 EN 60715 2000mm	98.300.0000.0 1
Steel, galv. zinc-plated and dichromated	slotted	35 x 27 x 7,5 EN 60715 2000mm	98.300.1000.0 1
Steel, unplated	unslotted	35 x 27 x 7,5 EN 60715 2000mm	98.300.0010.0 1



## MOUNTING RAIL 35 X 15 ACCORDING TO DIN EN 60715

• Length 1 m/2 m

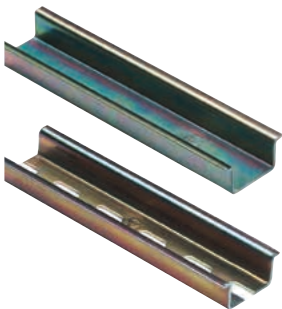

Description	Type	Part No.	Std. Pack
Steel, galv. zinc-plated and dichromated	unslotted	35 x 27 x 15 EN 60715 2000mm	98.370.0000.0 1
Steel, galv. zinc-plated and dichromated	slotted	35 x 27 x 15 EN 60715 2000mm	98.370.1000.0 1
Steel, galv. zinc-plated and dichromated	slotted	35 x 27 x 15 EN 60715 1000mm	98.375.1000.0 10
Steel, stainless steel	slotted	35 x 27 x 15 EN 60715 2000mm	98.370.1001.0 1

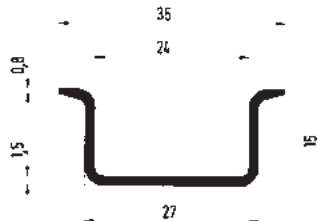

## MOUNTING RAIL 35 X 15 ACCORDING TO DIN EN 60715

• Length 2 m

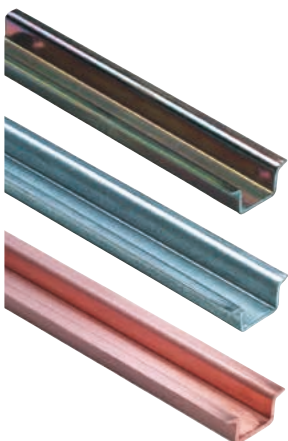

Description	Type	Part No.	Std. Pack
Steel, galv. zinc-plated and dichromated	unslotted	35 x 24 x 15 EN 60715 2000mm	98.360.0000.0 1
Steel, hot-galvanized	unslotted	35 x 24 x 15 EN 60715 ZN 2000mm	98.360.0004.0 1
E-copper	unslotted	35 x 24 x 15 EN 60715 CU 2000mm	98.380.0000.0 10

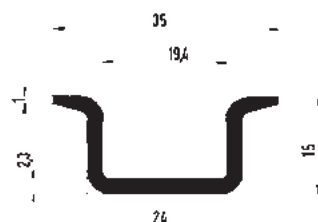

## MOUNTING RAIL 15X5,5 ACCORDING TO DIN EN 60 715

• Length 1 m/2 m

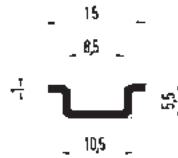
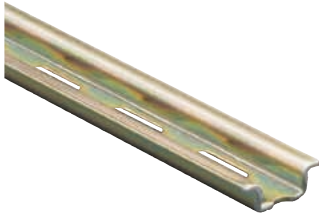

Description	Type	Part No.	Std. Pack	
Steel, galv. zinc-plated and dichromated	slotted	9021 / 15 x 5,5 EN 60715 2000mm	98.090.0015.0	10
Steel, galv. zinc-plated and dichromated	slotted	9021 / 15 x 5,5 EN 60715 1000mm	98.090.0000.0	1

## MOUNTING RAIL 32 ACCORDING TO DIN EN 60 715

• Length 2 m

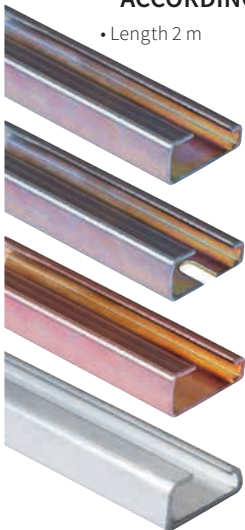

Description	Type	Part No.	Std. Pack	
Steel, galv. zinc-plated and dichromated	unslotted	9006 EN 60715 G-32 2000mm	98.190.0000.0	1
Steel, galv. zinc-plated and dichromated	slotted	9006 EN 60715 G-32 2000mm	98.190.1000.0	1
E-copper	unslotted	9006 E-CU 2000mm	98.220.0000.0	10
Aluminium	unslotted	9006 AL 2000mm	98.210.0000.0	1

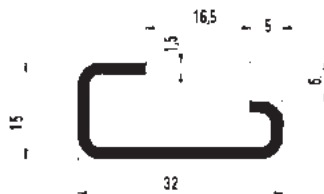

## ACCESSORIES

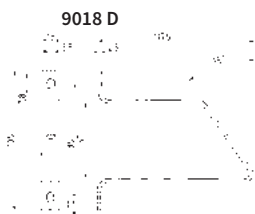

9018 D



9018 H



9018 N

ACCESSORIES	Type	Part No.	Std. Pack
Angled support bracket with mounting material	9018 D	Z5.516.2511.0	50
Angled support bracket with mounting material	9018 H	Z5.516.2711.0	50
Angled support bracket with mounting material	9018 N	Z5.516.2811.0	50

# END CLAMPS

## END CLAMP FOR TS 35 SNAP-ON MOUNTING

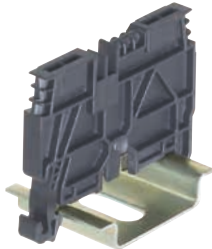

Description	Type	Part No.	Std. Pack
End clamp TS 35	5 mm wide WEF 2 /35	Z5.523.9453.0	100

## END CLAMP FOR TS 35 SNAP-ON MOUNTING

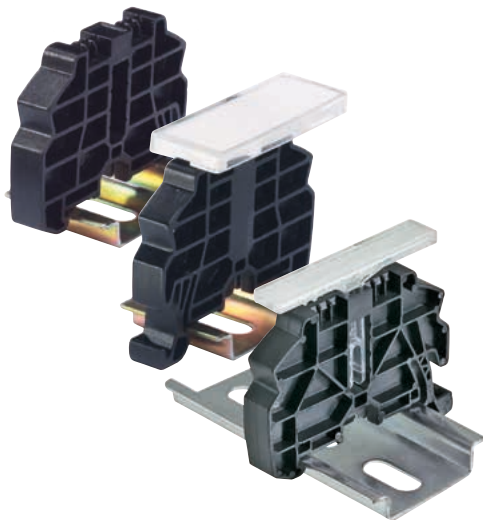

Description	Type	Part No.	Std. Pack
End clamp TS 35	8 mm wide WEF 1 /35	Z5.523.9353.0	100
End clamp TS 35 with marking facilities	17,5 mm wide WEF 1 BS /35	69.920.1053.0	100
End clamp TS 35 with marking facilities	8 mm wide WEF 1 BSS /35	69.920.1253.0	100

ACCESSORIES	Type	Part No.	Std. Pack
Marking tag for WEF 1 /35	wide BS/R	Z4.243.8453.0	100
Marking cardboard in perforated sheets	100 tags/sh.	04.019.0289.0	10
Marking tag for WEF 1 /35	small	04.243.8550.0	10
Marking cardboard in perforated sheets	small	04.019.1189.0	10

## END CLAMP FOR TS 35 SCREW MOUNTING



Description	Type	Part No.	Std. Pack
End clamp TS 35	8 mm wide 9708/2 S 35	Z5.522.8553.0	100
End clamp TS 35 with marking facilities	17,5 mm wide 9708/2 BS 35	69.920.0553.0	100

ACCESSORIES	Type	Part No.	Std. Pack
Marking cardboard in perforated sheets	100 tags/sh.	04.019.0289.0	10

# END BRACKETS / BUSBAR SUPPORT



## END CLAMP WITH WITH U-FOOT SCREW MOUNTING

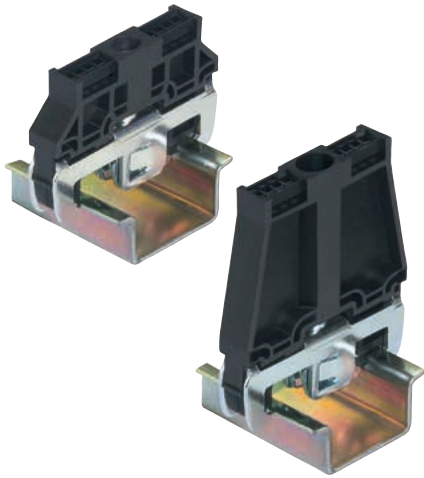

Description	Type	Part No.	Std. Pack	
End clamp with U-foot	10 mm wide WE 1 /U	Z5.523.5753.0	100	
End clamp with U-foot with marking facilities	17,5 mm wide WE 1 BS /U	69.920.0753.0	100	
End clamp with U-foot	10 mm wide WE 2 /U	Z5.523.5653.0	100	
End clamp with U-foot with marking facilities	17,5 mm wide WE 2 BS /U	69.920.0653.0	100	
ACCESSORIES		Type	Part No.	Std. Pack
Marking cardboard in perforated sheets		100 tags/sh.	04.019.0289.0	10

## END CLAMP FOR TS 15 SCREW MOUNTING



Description	Type	Part No.	Std. Pack
End clamp, plastic	7,5 mm wide 9208 S 15	Z5.522.7553.0	100
End clamp, steel	5 mm wide 9222 S 15	Z5.522.5010.0	100

## BUSBAR SUPPORT FOR N-BUSBAR FASTENING, SCREWLESS

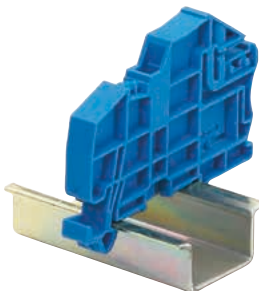

Description	Type	Part No.	Std. Pack	
End bracket/busbar support	8 mm wide WKIF SH/E/35 *	Z1.108.8453.0	100	
ACCESSORIES		Type	Part No.	Std. Pack
Marking tag for WKIF SH/E/35	Wide BS/R	Z4.243.8453.0	100	
Label carton in perf. sheets	Wide	04.019.0289.0	10	
Marking tag	Narrow	04.243.8550.0	10	
Label carton in perf. sheets	Narrow	04.019.1189.0	10	

\* Distance between WKIF SH and WKIF SH max. 200 mm

Description	Type	Part No.	Std. Pack
Busbar support	2 mm wide WKIF SH/35	01.108.7653.0	10
Fits installation terminals WKIF and WKIS			



# WIEPRINT.

---

## The printer for all current marking systems

Individual marking – at Wieland, that means wieprint, is a high performance marking system with which you can professionally create labels, from individual marking tags to serial marking, for your strip terminals. But wieprint offers still more! In addition to marking tags for series terminals, you can also print stickers, labels, or cable markings for all applications in the control cabinet.



- + Extremely versatile use
- + Prints marking tags efficiently and individually
- + Simple operation





### EXTREMELY VERSATILE USE

- For all Wieland series terminals
- For many other brands
- For identifying cables, switching elements, pushbuttons and many other control cabinet components



### SIMPLE OPERATION

- High performance marking software
- Operation via software interface or directly on device
- Integrated LCD display
- Easy to maintain – just change the printing ribbons



### PRINTS MARKING TAGS EFFICIENTLY AND INDIVIDUALLY

- Thermal transfer print for high quality, durable marking
- High print speed – up to 8500 tags/hour
- Automatic operation, including magazine, possible



# THERMAL TRANSFER PRINTER

## THERMAL TRANSFER PRINTER WIEPRINT



Description	Typ	Part No.	Std. Pack
Complete package	wieprint	95.503.0000.0	1

**Scope of delivery:** Thermal transfer printer wieprint, 1 x power supply cable, 1 x USB 2.0 cable, 1 x printer ribbon black, 1 x cleaning ribbon, 1 x holding plate ,Reihenklammen R0017'

**Description:** wieprint the printer system for marking DIN rail terminal blocks an other marking tags in the control cabinet.

Software and manual available at: [www.wieland-electric.com/en/service](http://www.wieland-electric.com/en/service)

### TECHNICAL DATA

Printing method	Thermo transfer
Operating modes	Automatic, semi-automatic, manual feed
Resolution	300 dpi
Dimensions	423 x 240 x 208 mm
Weight	9.5 kg
Fonts	Windows True Type
Graphics formats	.gif, .jpg, .jpeg, .bmp, .wmf
Printing speed	up to 60 mm/s
Interface	USB 2.0
Voltage	100V to 240V AC, 50/60Hz
Power, max.	135 W

## ACCESSORIES FOR THERMAL TRANSFER PRINTERS WIEPRINT

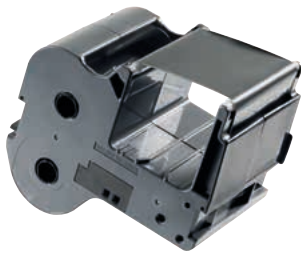

Description	Typ	Part No.	Std. Pack
<b>Accessories for thermal transfer printers wieprint</b>			
Printer ribbon black (l = 130 m)	wieprint FB sw	95.503.0010.1	3
Printer ribbon red (l = 130 m)	wieprint FB rt	95.503.0010.5	3
Cleaning ribbon (l = 8 m)	wieprint RB	95.503.0012.0	1
Cleaning roll	wieprint RR	95.503.0013.0	1
Holding plate wire/cable marking, directly printable	wieprint P3	95.503.0014.0	1
Magazine for automatic mode	wieprint MAG	95.503.0005.0	1
Holding plate wire marking / Marking sleeves	wieprint P1	95.503.0006.0	1
Support base for printing system	wieprint SB	95.503.0004.0	1

# MARKING OF DIN RAIL TERMINAL BLOCKS



## MARKING TAGS FOR DIN RAIL TERMINAL BLOCKS



Description	Typ	Part No.	Std. Pack	
<b>Marking tags for DIN rail terminal blocks, unmarked</b>				
Size 3.5 x 9.1 mm	WMP 3,5 SI2KTB3590DW	04.403.0056.0	12	
Size 5.0 x 8.5 mm	WMP 5 SI2KTB5085DW	04.405.0056.0	12	
Size 6.0 x 8.5 mm	WMP 6 SI2KTB6085DW	04.406.0056.0	12	
Size 6.0 x 10 mm	WMP 6 SI2KTB6010DW	04.406.0156.0	12	
Size 8.0 x 8.5 mm	WMP 8 SI2KTB8085DW	04.408.0056.0	12	
<b>TECHNICAL DATA</b>				
	<b>3,5 x 9,1 mm</b>	<b>5.0 x 8.5 mm</b>	<b>6.0 x 8.5 mm/10 mm</b>	<b>8.0 x 8.5 mm</b>
Width mm	3.5	5 and 10	6 and 12	8 and 16
Number of tags / plate	75	45	45	25
Packing unit plates / box	12	12	12	12

## MARKING STRIPS FOR DIN RAIL TERMINAL BLOCKS



Description	Typ	Part No.	Std. Pack
<b>Marking strips for DIN rail terminal blocks</b>			
for series WTP 1.5	WMP 3,5 S-SI2K09105W	04.400.0281.2	20
for series WKF 1.5	WMS SI2K06130W	04.400.0081.2	20
<b>TECHNICAL DATA</b>			
Number of strips / plate	3		
Packing unit plates / box	20		

## MARKING TAGS FOR DIN RAIL TERMINAL BLOCKS WEIDMÜLLER / WAGO



Description	Typ	Part No.	Std. Pack
<b>Marking tags for DIN rail terminal blocks, unmarked, Weidmüller / Wago</b>			
Size 5 x 10 mm	WMP SI2KTB5010LWK	04.405.1056.0	12
<b>TECHNICAL DATA</b>			
Number of tags / plate	45		
Packing unit plates / box	12		

## MARKING TAGS FOR DIN RAIL TERMINAL BLOCKS PHOENIX CONTACT



Description	Typ	Part No.	Std. Pack
<b>Marking tags for DIN rail terminal blocks, unmarked, Phoenix Contact</b>			
Size 5 x 9 mm	WMP SI2KTB5209EW	04.405.1156.0	12
Size 5 x 10 mm	WMP SI2KTB5210CW	04.405.1256.0	12
<b>TECHNICAL DATA</b>			
Number of tags / plate	45		
Packing unit plates / box	12		

# MARKING FOR WIRES

## MARKING SLEEVES



Description	Typ	Part No.	Std. Pack
<b>Marking sleeves, push-fit</b>			
Wire diameters 1.5 – 2.5 mm	WMS 201/15	04.410.0181.0	1000
Wire diameters 2 – 4 mm	WMS 202/15	04.410.0281.0	1000
Wire diameters 4 – 7 mm	WMS 203/15	04.410.0381.0	500
Wire diameters 6 – 10 mm	WMS 204/15	04.410.0481.0	500
Wire diameters 8 – 14 mm	WMS 205/15	04.410.0581.0	200
<b>Marking sleeves, snap-on</b>			
Wire diameters 2 – 3.5 mm	WMS 301/15	04.410.0681.0	1000
Wire diameters 2.8 – 5 mm	WMS 302/15	04.410.0781.0	1000
Wire diameters 5 – 8 mm	WMS 303/15	04.410.0881.0	500
Wire diameters 8 – 10 mm	WMS 304/15	04.410.0981.0	500
<b>Technical data</b>			
Material	PVC		
Color		transparent	
Length mm	15		

## MARKING TAGS FOR WIRE MARKERS, UNMARKED



Description	Typ	Part No.	Std. Pack
<b>Marking tags for wire markers, unmarked</b>			
Size 15 x 4 mm, color white	WMS Si2K02W/15N	04.410.1081.2	32
Size 15 x 4 mm, color yellow	WMS Si2K02Y/15N	04.410.1081.8	32
<b>TECHNICAL DATA</b>			
Material	PC / ABS		
Number of tags / plate	24		
Packing unit plates / box	32		

## WIRE MARKERS



Description	Typ	Part No.	Std. Pack
<b>Wire markers, directly printable</b>			
Wire diameters 1 – 3.8 mm	WMS Si2KTM02W/10	04.410.1281.2	22
<b>TECHNICAL DATA</b>			
Color	white		
Material	PC		
Length mm	10		
Number of tags / plate	33		
Packing unit plates / box	22		

# MARKING FOR CABLES



## CABLE MARKING



Description	Typ	Part No.	Std. Pack
<b>Cable marking, unmarked</b>			
Size: 15 x 80 mm, directly printable, color yellow	WMS SI2KCT1580Y	04.410.1481.8	15
<b>TECHNICAL DATA</b>			
Material	PVC		
Number of tags / plate	12		
Packing unit plates / box	15		

## MARKING SLEEVES



Description	Typ	Part No.	Std. Pack
<b>Marking sleeves</b>			
Size 7 x 46, color transparent	WMS SIT0003X050	04.410.1581.0	224
Size 15 x 67, color transparent	WMS SIT0004X070	04.410.1781.0	96
Size 9 x 20 mm, color transparent	WMS SI1001	04.410.1981.0	240
<b>TECHNICAL DATA</b>			
Material	PVC		

## MARKING TAGS



Description	Typ	Part No.	Std. Pack
<b>Marking tags for marking sleeves</b>			
Size 7 x 46, color white	WMS SI2K0746W	04.410.1681.2	40
Size 15 x 67, color white	WMS SI2K1567W	04.410.1881.2	25
Size 9 x 20 mm, color white	WMS SI2K1001W	04.410.2081.2	40
Size 9 x 20 mm, color yellow	WMS SI2K1001Y	04.410.2081.8	40
<b>TECHNICAL DATA</b>			
	<b>7 x 46 mm</b>	<b>15 x 67 mm</b>	<b>9 x 20 mm</b>
Material	PVC		
Number of tags / plate	28	4	60
Packing unit plates / box	40	25	40



# MARKING FOR DEVICES

## MARKING TAGS



Description	Typ	Part No.	Std. Pack		
<b>Marking tags, blank</b>					
Size 7 x 20 mm, color white	WMS SI2K40720W	04.420.0181.2	25		
Size 7 x 20 mm, color yellow	WMS SI2K40720Y	04.420.0181.8	25		
Size 8 x 17 mm, color white	WMS SI2K40817W	04.420.0381.2	25		
Size 9 x 20 mm, color white	WMS SI2K40920W	04.420.0481.2	25		
Size 9 x 35 mm, color white	WMS SI2K40935W	04.420.0581.2	25		
Size 10 x 25 mm, color white	WMS SI2K41025W	04.420.0681.2	20		
<b>TECHNICAL DATA</b>					
	<b>7 x 20 mm</b>	<b>8 x 17 mm</b>	<b>9 x 20 mm</b>	<b>9 x 35 mm</b>	<b>10 x 25 mm</b>
Material	PVC				
Number of tags / plate	70	77	60	36	30
Packing unit plates / box	25	25	25	25	20

## MARKING ADHESIVE LABEL



Description	Typ	Part No.	Std. Pack	
<b>Marking adhesive label, unmarked</b>				
Size 6 x 15 mm, color white	WMS SI2KFX0615W	04.420.1581.2	52	
Size 6 x 15 mm, color yellow	WMS SI2KFX0615Y	04.420.1581.8	52	
Size 7 x 20 mm, color white	WMS SI2KFX0720W	04.420.1681.2	50	
Size 7 x 20 mm, color yellow	WMS SI2KFX0720Y	04.420.1681.8	50	
Size 9 x 15 mm, color white	WMS SI2KFX0915W	04.420.1781.2	45	
Size 9 x 15 mm, color yellow	WMS SI2KFX0915Y	04.420.1781.8	45	
Size 22 x 22 mm, color white	WMS SI2KFX2222W	04.420.1881.2	50	
<b>TECHNICAL DATA</b>				
	<b>6 x 15 mm</b>	<b>7 x 20 mm</b>	<b>9 x 15 mm</b>	<b>22 x 22 mm</b>
Material	Vinyl			
Number of tags / plate	117	70	78	16
Packing unit plates / box	52	50	45	50



# MARKING FOR THE CONTROL CABINET AND FOR BUTTONS

## TYPE PLATES FOR THE CONTROL CABINET

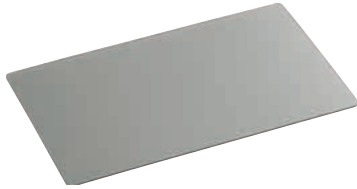

Description	Typ	Part No.	Std. Pack
<b>Type plates, PVC, unmarked</b>			
Size 30 x 70 mm, color white	WMS SI2K43070W	04.420.0781.2	20
Size 30 x 70 mm, color metallic	WMS SI2K43070M	04.420.0781.0	20
Size 30 x 70 mm, color yellow	WMS SI2K43070Y	04.420.0781.8	20
Size 60 x 100 mm, color white	WMS SI2K460100W	04.420.1081.2	15
Size 60 x 100 mm, color metallic	WMS SI2K460100M	04.420.1081.0	15
Size 60 x 100 mm, color yellow	WMS SI2K460100Y	04.420.1081.8	15

TECHNICAL DATA			
Material	PVC		
Number of tags / plate	1		

## MARKING FOR TYPE PLATES

- holder for marking tags
- marking tag



Description	Typ	Part No.	Std. Pack
<b>Marking for type plates</b>			
Holder for marking tags	WMS SIT0B05	04.420.1381.0	192
Marking tag size 15 x 27 mm	WMS SI2K1527W	04.420.1481.2	11

TECHNICAL DATA			
Material	PVC		
Number of tags / plate	18		
Packing unit plates / box	11		

## MARKING TAG

- for the button
- adhesive label



Description	Typ	Part No.	Std. Pack
<b>Marking tag for the button</b>			
adhesive label size 15 x 27 mm, color white	WMS SI2K41527W	04.420.1281.2	11
adhesive label size 15 x 27 mm, color metallic	WMS SI2K41527M	04.420.1281.0	11

TECHNICAL DATA			
Material	PVC / ACR		
Number of tags / plate	18		
Packing unit plates / box	11		



# WIEPLOT.

## The powerful marking system for your DIN rail terminals

Together with the wieplot plotter you have a powerful marking system that enables you to work professionally from the individual marking tag to series marking of your terminal block assemblies. You feel confident with the system due to its easy handling and visual representation of your marking, even when you use it for the first time. But wieplot offers even more! In addition to the marking tags for DIN rail terminal blocks you can also print self-adhesive tags and labels or cable markings. A slight modification can even make your plotter a powerful engraving system.

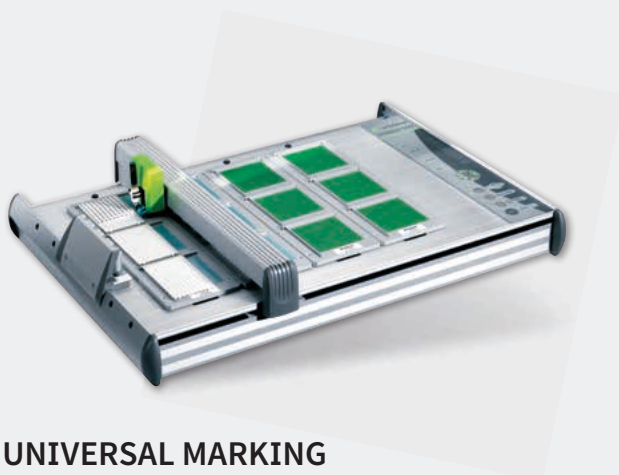

### UNIVERSAL MARKING WITH WIEPLOT

- Marks all common marking systems available for DIN rail terminal blocks
- Different marking tags can be marked individually in one single work step
- Marking of labels, self-adhesive tags and cables is possible



### DURABLE AND SAFE MARKING WITH ENGRAVING SYSTEM WIEPLOT

- Easy modification to wieplot to make it an engraving system
- Engraving of multi-layer plastic boards
- Clean and dust-proof operation due to integrated vacuum device
- Create individual layouts

# WIEMARC.

## The intuitive labelling software: Easy and quick to configure

- Simple and intuitive user interface
- Direct graphical display of the marking tags including plausibility check
- Customized layouts can be created individually
- Data import from CAD, Excel, text or wieplan

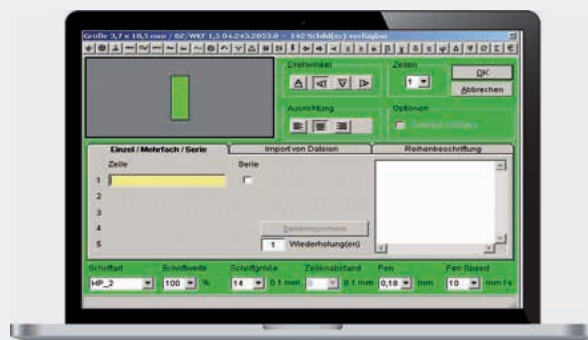

# THE PLOTTER SYSTEM WIEPLOT AND WIEPLOT BASIC



## PLOTTER SYSTEM

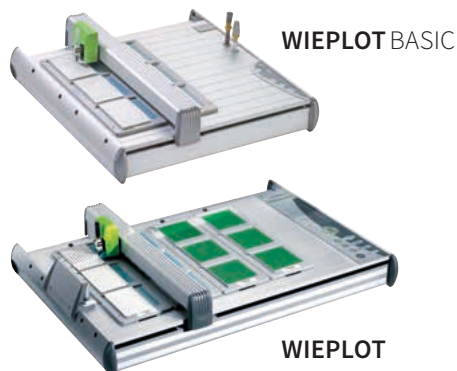

Description	Type	Part No.	Std. Pack
Complete package	wieplot BASIC	95.502.0607.0	1
Complete package	wieplot	95.502.0604.0	1

**Contents:** Plotter wieplot, data cable and manual, 4 receptacles (wieplot) / 2 receptacles (wieplot BASIC) for WSB (Wieland standard marking system), accessories kit, software

### TECHNICAL DATA

Resolution	0.01 mm
Accuracy	+ / - 0.05 mm
Power supply unit	50 / 60 Hz, 100 - 240 V
Output voltage	24 V DC 1.4 A
Current input	app. 0.3 A at 220 V
Approval	UL-UL1950, CSA 950, VDE EN 60950
Radio interf. suppr.	FCC class B, FCC sect. 15 and VDE class B
Dimension / Weight – wieplot BASIC	440 mm x 440 mm x 125 mm / 6 kg
Dimension / Weight – wieplot	660 mm x 440 mm x 125 mm / 8 kg
Interfaces	USB Level 1.1, parallel

## ACCESSORIES FOR WIEPLOT



Plotter pens for wieplot	Part No.	Type	Part No.
Plotter pen 0.18 mm	95.502.0118.0	Ink cartridge P2.0, 5x1ml	95.502.0199.0
Plotter pen 0.25 mm	95.502.0125.0	Cleaning set	95.502.0198.0
Plotter pen 0.35 mm	95.502.0135.0	Pen cleaner	95.502.0197.0
Plotter pen 0.50 mm	95.502.0150.0	Dust protection hood	95.502.0612.0
Plotter pen 0.70 mm	95.502.0170.0	Service kit – pen station	95.502.0613.0
Plotter pen 1.00 mm	95.502.0100.0	Seal inserts kit	
Dispos plotter pen 0.25 mm	95.502.0125.1		
Dispos plotter pen 0.35 mm	95.502.0135.1		
Dispos plotter pen-D ED 0.25 mm	95.502.0225.1		
Dispos plotter pen-D ED 0.35 mm	95.502.0235.1		

Receptacles for marking plates	
Type	Part No.
Receptacle for WSB	95.502.0620.0
Receptacle for BZ/WKF 15,	95.502.0627.0
Receptacle for BZ/WKF 1,5/10	95.502.0628.0

## ENGRAVING UNIT FOR WIEPLOT



Description	Type	Part No.	Std. Pack
Engraving unit	wieplot E-UNIT	95.502.0700.0	1

**Contents:** Engraving spindle, engraving head (with fuse and counter bearing), control unit wieplot VEC, vacuum cleaner wieplot VC, connection cables

### Description:

The system is set up for engraving multi-layer plastic tags. The Plotboard A4 in a 297 x 202 mm format is the receptacle for marking paper sheets and labels and also enables engraving of plastic boards.

ACCESSORIES	Type	Part No.	Std. Pack
Graver SET, complete	SET	95.502.0710.0	1
Graver	0.2 mm	95.502.0710.2	1
Graver	0.3 mm	95.502.0710.3	1
Graver	0.4 mm	95.502.0710.4	1
Graver	0.5 mm	95.502.0710.5	1
Graver	0.7 mm	95.502.0710.7	1
Graver	1.0 mm	95.502.0711.0	1
Receptacle	Plottboard A4	95.502.0625.0	1

## MARKING PLATES

• For wieplot

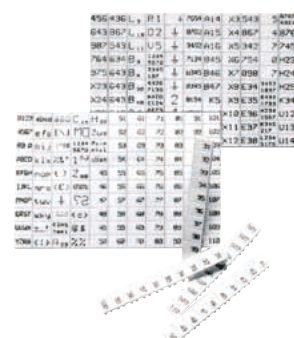

Description	Type	Part No.	Std. Pack
<b>Unmarked</b>			
Width 3.5 x 9 mm*	120 tags per plate	WMP 3,5 S-SI2K09105W	04.400.0281.2 20
Width 4 x 5 mm	100 tags per plate	9705 4/10/10	Z4.243.2053.0 10
Width 5 x 8.3 mm	110 tags per plate	9705 A/5/10/11	Z4.242.5053.0 10
Width 5 x 14 mm	60 tags per plate	9705 AL/5/10/6	Z4.242.5153.0 10
Width 6 x 8.3 mm	110 tags per plate	9705 A/6/10/11	Z4.242.6053.0 10
Width 6 x 14 mm	60 tags per plate	9705 AL/6/10/6	Z4.242.6353.0 10
Width 8 x 8.3 mm	70 tags per plate	9705 A/8/10/7	Z4.242.8053.0 10

\* Receptacle plate on request

# MARKING ACCESSORIES

## SINGLE MARKING TAG ALL BLOCKS/ 5 MM WIDE AND LARGER

<sup>\*)</sup> Custom marking upon request



Description	Type	Part No.	Std. Pack
<b>Unmarked</b>			
Width 5 x <b>8.3</b> mm	9705 A	04.242.0850.0	500
Width 5 x <b>14</b> mm	9705 AL	04.242.1553.0	500
<b>Marked</b>			
Width 5 x <b>8.3</b> mm	9705 AB <sup>*)</sup>	04.842.0850.0	500
Width 5 x <b>14</b> mm	9705 ALB <sup>*)</sup>	04.842.1553.0	500

## MARKING STRIPS WTP 1.5 MM<sup>2</sup>/3.5 MM WIDE

<sup>\*)</sup> Custom marking upon request



Description	Type	Part No.	Std. Pack
<b>Marked</b>			
<sup>*)</sup>	WMP 3,5 / B <sup>*)</sup>	04.543.0056.0	10
1 - 15 (5x)	WMP 3,5 / B 1 - 15	04.543.0156.0	10
16 - 30 (5x)	WMP 3,5 / B 16 - 30	04.543.0256.0	10
31 - 45 (5x)	WMP 3,5 / B 31 - 45	04.543.0356.0	10
46 - 60 (5x)	WMP 3,5 / B 46 - 60	04.543.0456.0	10
61 - 75 (5x)	WMP 3,5 / B 61 - 75	04.543.0556.0	10
76 - 90 (5x)	WMP 3,5 / B 76 - 90	04.543.0656.0	10
91 - 105 (5x)	WMP 3,5 / B 91 - 105	04.543.0756.0	10
106 - 120 (5x)	WMP 3,5 / B 106 - 120	04.543.0856.0	10
121 - 135 (5x)	WMP 3,5 / B 121 - 135	04.543.0956.0	10
136 - 150 (5x)	WMP 3,5 / B 136 - 150	04.543.1056.0	10
⊕ (5x)	WMP 3,5 / B SLZ	04.553.0056.0	25
⊖ (5x)	WMP 3,5 / B ERDZ	04.553.0156.0	25
+ (5x)	WMP 3,5 / B +	04.553.0256.0	25
- (5x)	WMP 3,5 / B -	04.553.0356.0	25
L1 (5x)	WMP 3,5 / B L1	04.553.0456.0	25
L2 (5x)	WMP 3,5 / B L2	04.553.0556.0	25
L3 (5x)	WMP 3,5 / B L3	04.553.0656.0	25
PE (5x)	WMP 3,5 / B PE	04.553.0756.0	25
SL (5x)	WMP 3,5 / B SL	04.553.3156.0	25
N (5x)	WMP 3,5 / B N	04.553.3256.0	25
F1 (5x)	WMP 3,5 / B F1	04.553.0956.0	25
F2 (5x)	WMP 3,5 / B F2	04.553.1056.0	25
L1,L2,L3,N,PE (5x)	WMP 3,5 / B L1L2L3NPE..	04.553.0856.0	25

## MARKING STRIPS WKF 1.5 MM<sup>2</sup>/4 MM WIDE

<sup>\*)</sup> Custom marking upon request



Description	Type	Part No.	Std. Pack
<b>Marking strips for center block marking</b>			
Unmarked	9705 A 4/10	04.243.2053.0	100
Marked	9705 A 4/10 B <sup>*)</sup>	04.843.2053.0	25
<b>Marking strips for outer block marking</b>			
Marked	9705 A 4/10/10	Z4.243.2053.0	10

## MARKING STRIPS 2.5 MM<sup>2</sup>/5 MM WIDE

<sup>\*)</sup> Custom marking upon request



Description	Type	Part No.	Std. Pack
<b>Unmarked</b>			
	9705 A/5/10	04.242.5053.0	25
<b>Marked</b>			
1 - 9	9705A/5/9 B 1 - 9	04.842.4953.0	25
<sup>*)</sup>	9705A/5/10 B	04.842.5053.0	25
1 - 10	9705A/5/10 B 1 - 10	04.845.0153.0	25
11 - 20	9705A/5/10 B 11 - 20	04.845.0253.0	25
21 - 30	9705A/5/10 B 21 - 30	04.845.0353.0	25
31 - 40	9705A/5/10 B 31 - 40	04.845.0453.0	25
41 - 50	9705A/5/10 B 41 - 50	04.845.0553.0	25
51 - 60	9705A/5/10 B 51 - 60	04.845.0653.0	25
61 - 70	9705A/5/10 B 61 - 70	04.845.0753.0	25
71 - 80	9705A/5/10 B 71 - 80	04.845.0853.0	25
81 - 90	9705A/5/10 B 81 - 90	04.845.0953.0	25
91 - 100	9705A/5/10 B 91 - 100	04.845.1053.0	25
⊕ (10x)	9705A/5/10B SLZ	04.855.0053.0	25
⊖ (10x)	9705A/5/10B ERDZ	04.855.0153.0	25
+ (10x)	9705A/5/10 B +	04.855.0253.0	25
- (10x)	9705A/5/10 B -	04.855.0353.0	25
L1 (10x)	9705A/5/10B L1	04.855.0453.0	25
L2 (10x)	9705A/5/10B L2	04.855.0553.0	25
L3 (10x)	9705A/5/10B L3	04.855.0653.0	25
PE (10x)	9705A/5/10B PE	04.855.0753.0	25
SL (10x)	9705A/5/10B SL	04.855.3153.0	25
N (10x)	9705A/5/10B N	04.855.3253.0	25
F1 (10x)	9705A/5/10B F1	04.855.0953.0	25
F2 (10x)	9705A/5/10B F2	04.855.1053.0	25
L1,L2,L3,N,PE (10x)	9705A/5/10B L1L2L3NPE..	04.855.0853.0	25
<b>With enlarged marking area</b>			
	9705 AL/5/10	04.242.5153.0	25





## MARKING STRIPS 4 MM<sup>2</sup>/6 MM WIDE

\*) Custom marking upon request



Description	Type	Part No.	Std. Pack
<b>Unmarked</b>	9705 A/6/10	04.242.6053.0	25
<b>Marked</b>	1 - 9	9705A/6/9 B 1 - 9	04.842.5953.0
	*)	9705A/6/10 B	04.842.6053.0
	1 - 10	9705A/6/10 B 1 - 10	04.846.0153.0
	11 - 20	9705A/6/10 B 11 - 20	04.846.0253.0
	21 - 30	9705A/6/10 B 21 - 30	04.846.0353.0
	31 - 40	9705A/6/10 B 31 - 40	04.846.0453.0
	41 - 50	9705A/6/10 B 41 - 50	04.846.0553.0
	51 - 60	9705A/6/10 B 51 - 60	04.846.0653.0
	61 - 70	9705A/6/10 B 61 - 70	04.846.0753.0
	71 - 80	9705A/6/10 B 71 - 80	04.846.0853.0
	81 - 90	9705A/6/10 B 81 - 90	04.846.0953.0
	91 - 100	9705A/6/10 B 91 - 100	04.846.1053.0
	⊕ (10x)	9705A/6/10 B SLZ	04.856.0053.0
	⊖ (10x)	9705A/6/10 B ERDZ	04.856.0153.0
	+ (10x)	9705A/6/10 B +	04.856.0253.0
	- (10x)	9705A/6/10 B -	04.856.0353.0
	L1 (10x)	9705A/6/10 B L1	04.856.0453.0
	L2 (10x)	9705A/6/10 B L2	04.856.0553.0
	L3 (10x)	9705A/6/10 B L3	04.856.0653.0
	PE (10x)	9705A/6/10 B PE	04.856.0753.0
	SL (10x)	9705A/6/10 B SL	04.856.3153.0
	N (10x)	9705A/6/10 B N	04.856.3253.0
	F1 (10x)	9705A/6/10 B F1	04.856.0953.0
	F2 (10x)	9705A/6/10 B F2	04.856.1053.0
	L1,L2,L3,N,PE (10x)	9705A/6/10 B L1L2L3NPE..	04.856.0853.0
<b>With enlarged marking area</b>	9705 AL/6/10	04.242.6353.0	25

## MARKING STRIPS 6 MM<sup>2</sup>/8 MM WIDE

\*) Custom marking upon request



Description	Type	Part No.	Std. Pack
<b>Unmarked</b>	9705 A/8/10	04.242.8053.0	25
<b>Marked</b>	1 - 9	9705A/8/9 B 1 - 9	04.842.7953.0
	*)	9705A/8/10 B	04.842.8053.0
	1 - 10	9705A/8/10 B 1 - 10	04.848.0153.0
	11 - 20	9705A/8/10 B 11 - 20	04.848.0253.0
	21 - 30	9705A/8/10 B 21 - 30	04.848.0353.0
	31 - 40	9705A/8/10 B 31 - 40	04.848.0453.0
	41 - 50	9705A/8/10 B 41 - 50	04.848.0553.0
	51 - 60	9705A/8/10 B 51 - 60	04.848.0653.0
	61 - 70	9705A/8/10 B 61 - 70	04.848.0753.0
	71 - 80	9705A/8/10 B 71 - 80	04.848.0853.0
	81 - 90	9705A/8/10 B 81 - 90	04.848.0953.0
	91 - 100	9705A/8/10 B 91 - 100	04.848.1053.0
	⊕ (10x)	9705A/8/10 B SLZ	04.858.0053.0
	⊖ (10x)	9705A/8/10 B ERDZ	04.858.0153.0
	+ (10x)	9705A/8/10 B +	04.858.0253.0
	- (10x)	9705A/8/10 B -	04.858.0353.0
	L1 (10x)	9705A/8/10 B L1	04.858.0453.0
	L2 (10x)	9705A/8/10 B L2	04.858.0553.0
	L3 (10x)	9705A/8/10 B L3	04.858.0653.0
	PE (10x)	9705A/8/10 B PE	04.858.0753.0
	SL (10x)	9705A/8/10 B SL	04.858.3153.0
	N (10x)	9705A/8/10 B N	04.858.3253.0
	F1 (10x)	9705A/8/10 B F1	04.858.0953.0
	F2 (10x)	9705A/8/10 B F2	04.858.1053.0
	L1,L2,L3,N,PE (10x)	9705A/8/10 B L1L2L3NPE..	04.858.0853.0

## MARKING STRIPS 10 MM<sup>2</sup>/10 MM WIDE 16 MM<sup>2</sup>/12 MM WIDE 35 MM<sup>2</sup>/16 MM WIDE 70 MM<sup>2</sup>/24 MM WIDE

Description	Type	Part No.	Std. Pack
<b>10 mm<sup>2</sup>/10 mm wide</b> for 5 blocks	9705 A/5/10/5 B	04.842.5553.0	25
<b>16 mm<sup>2</sup>/12 mm wide</b> for 5 blocks	9705 A/6/10/5 B	04.842.6553.0	25
<b>35 mm<sup>2</sup>/16 mm wide</b> for 5 blocks	9705 A/8/10/5 B	04.842.8553.0	25
<b>70 mm<sup>2</sup>/24 mm wide</b> for 4 blocks	9705 A/8/10/5 B	04.842.8553.0	25

Specify required marking with part no.



# MARKING ACCESSORIES

## TEAR-OFF MARKING STRIPS MARKED WITH NUMBERS

- With 10 marking tags
- For single symbol marking



Description	Type	Part No.	Std. Pack	
<b>Unmarked</b>	9704 A	04.241.1150.0	25	
<b>Marked with the same number</b>				
1	9704 A/1 B	04.841.1150.0	25	
2	9704 A/2 B	04.841.1250.0	25	
3	9704 A/3 B	04.841.1350.0	25	
4	9704 A/4 B	04.841.1450.0	25	
5	9704 A/5 B	04.841.1550.0	25	
6	9704 A/6 B	04.841.1650.0	25	
7	9704 A/7 B	04.841.1750.0	25	
8	9704 A/8 B	04.841.1850.0	25	
9	9704 A/9 B	04.841.1950.0	25	
0	9704 A/0 B	04.841.2050.0	25	
<b>Marked with consecutive numbers</b>				
1-0	9704 A/1-0 B	04.841.2150.0	25	
<b>Marked with the same symbols</b>				
+	9704 A/+	04.841.7450.0	25	
-	9704 A/-	04.841.7550.0	25	
/	9704 A//	04.841.7650.0	25	
.	9704 A/.	04.841.7750.0	25	
<b>Set, marked with same numbers (= 10 x 25 strips = 2.500 numbers)</b> 111 up to 000			04.841.9050.0	1

## TEAR-OFF MARKING STRIPS MARKED WITH UPPER CASE LETTERS

- With 10 marking tags
- For single symbol marking



Description	Type	Part No.	Std. Pack	
<b>Marked with the same upper case letters</b>				
A	9704 A /AG B	04.841.2250.0	25	
B	9704 A /BG B	04.841.2350.0	25	
C	9704 A /CG B	04.841.2450.0	25	
D	9704 A /DG B	04.841.2550.0	25	
E	9704 A /EG B	04.841.2650.0	25	
F	9704 A /FG B	04.841.2750.0	25	
G	9704 A /GG B	04.841.2850.0	25	
H	9704 A /HG B	04.841.2950.0	25	
I	9704 A /IG B	04.841.3050.0	25	
J	9704 A /JG B	04.841.3150.0	25	
K	9704 A /KG B	04.841.3250.0	25	
L	9704 A /LG B	04.841.3350.0	25	
M	9704 A /MG B	04.841.3450.0	25	
N	9704 A /NG B	04.841.3550.0	25	
O	9704 A /OG B	04.841.3650.0	25	
P	9704 A /PG B	04.841.3750.0	25	
Q	9704 A /QG B	04.841.3850.0	25	
R	9704 A /RG B	04.841.3950.0	25	
S	9704 A /SG B	04.841.4050.0	25	
T	9704 A /TG B	04.841.4150.0	25	
U	9704 A /UG B	04.841.4250.0	25	
V	9704 A /VG B	04.841.4350.0	25	
W	9704 A /WG B	04.841.4450.0	25	
X	9704 A /XG B	04.841.4550.0	25	
Y	9704 A /YG B	04.841.4650.0	25	
Z	9704 A /ZG B	04.841.4750.0	25	
<b>Set, marked with same upper case letters (= 26 x 25 strips = 6.500 numbers)</b> A up to Z GB			04.841.9150.0	1

## TEAR-OFF MARKING STRIPS MARKED WITH LOWER CASE LETTERS

- With 10 marking tags
- For single symbol marking



Description	Type	Part No.	Std. Pack	
<b>Marked with the same lower case letters</b>				
a	9704 A /AK B	04.841.4850.0	25	
b	9704 A /BK B	04.841.4950.0	25	
c	9704 A /CK B	04.841.5050.0	25	
d	9704 A /DK B	04.841.5150.0	25	
e	9704 A /EK B	04.841.5250.0	25	
f	9704 A /FK B	04.841.5350.0	25	
g	9704 A /GK B	04.841.5450.0	25	
h	9704 A /HK B	04.841.5550.0	25	
i	9704 A /IK B	04.841.5650.0	25	
j	9704 A /JK B	04.841.5750.0	25	
k	9704 A /KK B	04.841.5850.0	25	
l	9704 A /LK B	04.841.5950.0	25	
m	9704 A /MK B	04.841.6050.0	25	
n	9704 A /NK B	04.841.6150.0	25	
o	9704 A /OK B	04.841.6250.0	25	
p	9704 A /PK B	04.841.6350.0	25	
q	9704 A /QK B	04.841.6450.0	25	
r	9704 A /RK B	04.841.6550.0	25	
s	9704 A /SK B	04.841.6650.0	25	
t	9704 A /TK B	04.841.6750.0	25	
u	9704 A /UK B	04.841.6850.0	25	
v	9704 A /VK B	04.841.6950.0	25	
w	9704 A /WK B	04.841.7050.0	25	
x	9704 A /XK B	04.841.7150.0	25	
y	9704 A /YK B	04.841.7250.0	25	
z	9704 A /ZK B	04.841.7350.0	25	
<b>Set, Marked with the same lower case letters (= 26 x 25 strips = 6.500 numbers)</b> a up to z KB			04.841.9250.0	1

## ASSORTMENT BOX

- For marking material



Description	Type	Part No.	Std. Pack
<b>Assortment box for 5 mm width</b>	S0 1/5	04.900.2053.0	1
Assortment for 5 mm width	1-100	9705 A/5/10 B	04.855.1153.0
	101-200	9705 A/5/10 B	04.855.1253.0
<b>Assortment box for 6 mm width</b>	S0 1/6	04.900.3053.0	1
Assortment for 6 mm width	1-100	9705 A/6/10 B	04.856.1153.0
	101-200	9705 A/6/10 B	04.856.1253.0
<b>Assortment box for 8 mm width</b>	S0 1/8	04.900.4053.0	1
Assortment for 8 mm width	1-100	9705 A/8/10 B	04.858.1153.0
	101-200	9705 A/8/10 B	04.858.1253.0
<b>Assortment box for tear-off marking tags</b> with 50 digits each	S0 1/0	04.900.1053.0	1
<b>Assortment box, empty</b>	S0 1	04.900.0000.0	1

## MARKING TAG CARRIER

- For all blocks



Description	Type	Part No.	Std. Pack
<b>Marking tag carrier, 4 digits</b>	9705 A/4	04.242.0950.0	200
<b>Marking tag carrier, 6 digits</b>	9705 A/6	04.242.1250.0	200
<b>Marking tag carrier, 45° angle</b>	9705 A/4 W	04.242.2853.0	200

## PARTITION

- With marking facilities



Description	Type	Part No.	Std. Pack
<b>Partition with carrier for marking tags</b> for TS 32 and TS 35		Z7.311.1755.0	10
for TS 15		Z7.311.2755.0	10
<b>Partition with carrier for marking cards</b> for TS 32 and TS 35		Z7.311.7055.0	10
<b>Accessories</b>			
Marking card in perforated sheets	100 tags/sheets	04.019.0289.0	10

# CROSS CONNECTORS AND JUMPER BARS

## CROSS CONNECTORS

- Cross connector poles can be individually removed.
- When cross connectors with removed poles are used, the rated voltage is reduced to 400 V.
- You can cut a 10-wire connector plug in half to form two 5-wire connector plugs, but an end cover plate or isolating plate must then be inserted.



Description	Type	Part No.	Std. Pack
<b>1.5 mm<sup>2</sup>, 3 mm wide</b>	IVB WTP 1,5-2	Z7.284.7027.0	10
	IVB WTP 1,5-3	Z7.284.7127.0	10
	IVB WTP 1,5-4	Z7.284.7227.0	10
	IVB WTP 1,5-5	Z7.284.7327.0	10
	IVB WTP 1,5-10	Z7.284.7427.0	10
<b>1.5 mm<sup>2</sup>, 4 mm wide</b>	IVB WKF 1,5-2	Z7.268.0227.0	10
	IVB WKF 1,5-3	Z7.268.0327.0	10
	IVB WKF 1,5-4	Z7.268.0427.0	10
	IVB WKF 1,5-5	Z7.268.0527.0	10
	IVB WKF 1,5-10	Z7.268.1027.0	10
	IVB WKF 1,5-20	Z7.268.2027.0	10
<b>2.5 mm<sup>2</sup>, 5 mm wide</b>	IVB WKF 2,5-2	Z7.280.6227.0	10
	IVB WKF 2,5-3	Z7.280.6327.0	10
	IVB WKF 2,5-4	Z7.280.6427.0	10
	IVB WKF 2,5-5	Z7.280.6527.0	10
	IVB WKF 2,5-6	Z7.280.6627.0	10
	IVB WKF 2,5-7	Z7.280.6727.0	20
	IVB WKF 2,5-8	Z7.280.6827.0	20
	IVB WKF 2,5-9	Z7.280.6927.0	20
	IVB WKF 2,5-10	Z7.280.7027.0	20
	IVB WKF 2,5-20	Z7.280.8027.0	20
	IVB WKF-V	Z7.261.1127.0	10
<b>4 mm<sup>2</sup>, 6 mm wide</b>	IVB WKF 4-2	Z7.261.1227.0	10
	IVB WKF 4-3	Z7.261.1327.0	10
	IVB WKF 4-4	Z7.261.1427.0	10
	IVB WKF 4-5	Z7.261.1527.0	10
	IVB WKF 4-6	Z7.261.1627.0	10
	IVB WKF 4-7	Z7.261.1727.0	10
	IVB WKF 4-8	Z7.261.1827.0	10
	IVB WKF 4-9	Z7.261.1927.0	10
	IVB WKF 4-10	Z7.261.2027.0	10
	<b>6 mm<sup>2</sup>, 8 mm wide</b>	IVB WKFN 6-2	Z7.282.5227.0
IVB WKFN 6-5		Z7.282.5527.0	10
I <sub>N</sub> : 41 A (57 A when using two cross connectors)			
<b>10 mm<sup>2</sup>, 10 mm wide</b>	IVB WKF 10-2	Z7.283.8227.0	10
<b>16 mm<sup>2</sup>, 12 mm wide</b>	IVB WKF 16-2	Z7.284.4227.0	10
<b>35 mm<sup>2</sup>, 16 mm wide</b>	IVB WKF 35-2	Z7.285.6227.0	10
	IVB WKF 35R10-2	Z7.285.6427.0	10
<b>Jumping cross connectors for WT 2,5, WTP 2,5/4 and WKFN 2,5</b>			
3-pole 1-3		99.013.9999.9	10
4-pole 1-4		99.014.9999.9	10
5-pole 1-5		99.015.9999.9	10
5-pole 1 to 3 to 5		99.031.9999.9	10
7-pole 1 to 3, 5 and 7		99.032.9999.9	10
9-pole 1 to 3, 5, 7 and 9		99.033.9999.9	10
11-pole 1 to 3, 5, 7, 9 and 11		99.034.9999.9	10
Additional combinations upon request			

## JUMPER BAR, INSULATED JUMPER COMB, INSULATED

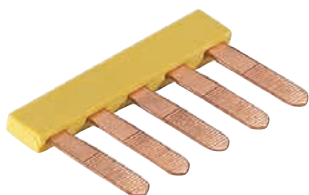

Description	Type	Part No.	Std. Pack
<b>WK 4 /U and WK 4 TK, 6 mm wide, 0.5 mm thick</b>			
Jumper comb, insulated	IVB 0,5 WK 4-2	Z7.255.0227.0	10
	IVB 0,5 WK 4-12	Z7.255.0227.0	10
<b>WK 4 /U and WK 4 TK, 6 mm wide, 1 mm thick</b>			
Jumper comb, insulated	IVB 1 WK 4-2	Z7.255.4227.0	10
	IVB 1 WK 4-12	Z7.255.4227.0	10
<b>WK 6, WKN 6 TK, WK 4 THSi 6,3x32</b>			
Jumper comb, insulated	IVK WKN 6 TK-2	Z7.255.8227.0	10
	IVK WKN 6 TK-3	Z7.255.8327.0	10
	IVK WKN 6 TK-4	Z7.256.8427.0	10
	IVK WKN 6 TK-5	Z7.256.8527.0	10
	IVK WKN 6 TK-6	Z7.256.8527.0	10

# COVER STRIPS AND TEST PLUGS



## COVER STRIP WITH WARNING SYMBOL

- Over 4 blocks, tension spring connection



Description	Type	Part No.	Std. Pack
<b>for tension spring connection</b>			
1.5 mm <sup>2</sup> , 4 mm wide	ADF 1,5/5 GELB	04.343.6953.8	10
2.5 mm <sup>2</sup> , 5 mm wide	ADFN 2,5/4 GELB	04.343.8353.8	10
4 mm <sup>2</sup> , 6 mm wide	ADF 4/4 GELB	04.343.6153.8	10
6 mm <sup>2</sup> , 8 mm wide	ADF 6/4 GELB	04.343.6253.8	10
10 mm <sup>2</sup> , 10 mm wide	ADF 10/4 GELB	04.343.6453.8	10
16 mm <sup>2</sup> , 12 mm wide	ADF 16/4 GELB	04.343.6653.8	10
35 mm <sup>2</sup> , 16 mm wide	ADF 35/5 GELB	04.343.9253.8	10

- Over 4 blocks, screw connection



<b>for screw connection</b>			
WKN 35/U, 16 mm wide, screw M5	AD 16/4 GELB	04.343.5256.8	10
WKN 70/U, 24 mm wide, screw M6	AD 24/4 GELB	04.343.5356.8	10
WKN 150/U, 28 mm wide, screw M8	ADN 28/4 GELB	04.343.5456.8	10

## TEST PLUG WITH TENSION SPRING CONNECTION

- For WT/WTP/WKF... terminal blocks
- For 2.5 mm<sup>2</sup>, 5 mm wide and 4 mm<sup>2</sup>, 6 mm wide



Description	Type	Part No.	Std. Pack
Test plug	PSWKC/F	Z1.299.9753.0	10
Blind piece		01.299.9753.0	10
Endplate	ZP/AP PS	07.312.6053.0	10

<b>GENERAL DATA</b>	
Width	5 mm / 6 mm*
Wire strip length	8 mm

<b>TECHNICAL DATA</b>	IEC	UL	CSA
-----------------------	-----	----	-----

Cross section solid	0.13 – 1.5 mm <sup>2</sup>
Cross section fine-stranded	0.13 – 1.5 mm <sup>2</sup>
Rated current	13.5 A
Rated voltage	400 V

**Note** \* For 6 mm spacing a ZP/AP PS is snapped on behind each test plug or blind piece.

## TEST PLUG

- 250 V / 2 A



Description	Type	Part No.	Std. Pack
Test plug 2.3 mm red	ST 2/2 RT	Z5.553.2921.0	10
Test plug 2.3 mm black	ST 2/2 SW	Z5.553.2921.1	50
Test plug 2.3 mm blue	ST 2/2 BL	Z5.553.2921.6	100
Test plug 4 mm black	ST 2/4 SW	Z5.553.3021.0	10



# TOOLS

## WIRE ENTRY GUIDES

- For conductors with cross sections smaller than 1 mm<sup>2</sup>



Description	Type	Part No.	Std. Pack
<b>1.5 mm<sup>2</sup>, 4 mm wide</b>			
for 0.13 – 0.2 mm <sup>2</sup> wires	LEL 1,5/1 WEISS	05.564.4253.0	10
for 0.25 – 0.5 mm <sup>2</sup> wires	LEL 1,5/2 GRAU	05.564.4353.0	10
<b>2.5 mm<sup>2</sup>, 5 mm wide</b>			
for 0.13 – 0.2 mm <sup>2</sup> wires	LELN 2,5/1 WEISS	05.564.3755.0	100
for 0.25 – 0.5 mm <sup>2</sup> wires	LELN 2,5/1 GRAU	05.564.3855.0	100
for 0.75 – 1.0 mm <sup>2</sup> wires	LELN 2,5/1 SCHWARZ	05.564.3955.0	100
<b>4 mm<sup>2</sup>, 6 mm wide</b>			
for 0.13 – 0.2 mm <sup>2</sup> wires	LEL 4/1 WEISS	05.561.8553.0	100
for 0.25 – 0.5 mm <sup>2</sup> wires	LEL 4/2 GRAU	05.561.8653.0	100
for 0.75 – 1.0 mm <sup>2</sup> wires	LEL 4/3 SCHWARZ	05.561.8753.0	100

## NOTCHING TOOL FOR CROSS CONNECTORS

- For 1.5 mm<sup>2</sup>, wide 4 mm wide
- For 2.5 mm<sup>2</sup>, 5 mm wide
- For 4 mm<sup>2</sup>, 6 mm wide

Description	Type	Part No.	Std. Pack
Notching tool	AKW /A	95.300.0500.0	1

## SCREWDRIVERS



Description	Type	Part No.	Std. Pack
<b>1.5 mm<sup>2</sup>, 4 mm wide</b>			
Uninsulated, long and straight	DIN 5264 A 0,4x2,5	06.502.4300.0	5
<b>2.5 mm<sup>2</sup>, 5 mm wide</b>			
Uninsulated, long and straight	DIN 5264 A 0,6x3,5	06.502.4000.0	10
Uninsulated, short and straight	DIN 5264 A 0,6x3,5 M	06.502.5000.0	10
Uninsulated, long and angled	DIN 5264 B 0,6x3,5 W	05.502.4100.0	10
Uninsulated, short and angled	DIN 5264 B 0,6x3,5 MW	05.502.4000.0	10
<b>4 mm<sup>2</sup>, 6 mm wide</b>			
Uninsulated, long and straight	DIN 5264 A 0,6x3,5	06.502.4000.0	10
Uninsulated, short and straight	DIN 5264 A 0,6x3,5 M	06.502.5000.0	10
Uninsulated, long and angled	DIN 5264 B 0,6x3,5 W	05.502.4100.0	10
Uninsulated, short and angled	DIN 5264 B 0,6x3,5 MW	05.502.4000.0	10
<b>6 mm<sup>2</sup>, 8 mm wide</b>			
	DIN 5264 A 0,8x4	06.502.4100.0	5
<b>10 mm<sup>2</sup>, 10 mm wide</b>			
	DIN 5264 A 1x5,5	06.502.4200.0	5
<b>16 mm<sup>2</sup>, 12 mm wide</b>			
	DIN 5264 A 1x5,5	06.502.4200.0	5
<b>35 mm<sup>2</sup>, 16 mm wide</b>			
	DIN 5264 A 1x5,5	06.502.4200.0	5

# FERRULES AND TOOLS



## FERRULES

### WITH INSULATING MATERIAL SLEEVE

**Materials:**

Sleeve: Polypropylene, temperature resistance 105°C, creepage resistant  
 Tube: E-Cu, galvanically tin-plated

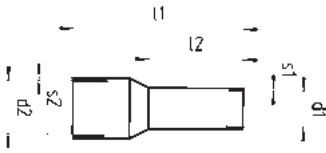

### WITHOUT INSULATING MATERIAL SLEEVE

**Materials:** Tube: E-Cu, galvanically tin-plated

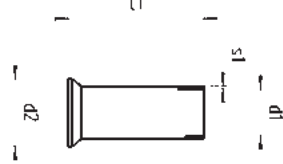

Cross section mm <sup>2</sup>		Color	Type	Part No.	Std. Pack
<b>Ferrules with insulating material sleeve according to DIN 46228 T4</b>					
0.50	norm.	white		06.600.2027.0	500
0.75	norm.	gray		06.600.2127.0	500
1.00	norm.	red		06.600.2227.0	500
1.50	norm.	black		06.600.2327.0	500
1.50	long	black		06.600.2427.0	500
2.50	norm.	blue		06.600.2527.0	500
2.50	long	blue		06.600.2627.0	500
4.00	norm.	gray		06.600.2727.0	500
4.00	long	gray		06.600.2827.0	100
6.00	norm.	yellow		06.600.2927.0	100
6.00	long	yellow		06.600.3027.0	100
10.00	norm.	red		06.600.3127.0	100
10.00	long	red		06.600.3227.0	100
16.00	norm.	blue		06.600.3327.0	100
16.00	long	blue		06.600.3427.0	100
25.00	mid-length	yellow		06.600.3527.0	50
<b>Ferrules without insulating material sleeve according to DIN 46228 T1</b>					
0.50	norm.			06.600.4027.0	1000
0.75	norm.			06.600.4127.0	1000
1.00	norm.			06.600.4227.0	1000
1.50	norm.			06.600.4327.0	1000
2.50	norm.			06.600.4427.0	1000
4.00	norm.			06.600.4527.0	1000
6.00	norm.			06.600.4627.0	500
10.00	norm.			06.600.4727.0	500
16.00	norm.			06.600.4827.0	100
25.00	norm.			06.600.4927.0	100
35.00	norm.			06.600.5027.0	100

## WIRE STRIPPERS

Description	Type	Part No.	Std. Pack
Wire strippers	AIW/A	95.350.0100.0	1
<b>GENERAL DATA</b>			
Wire strip length	0.08 - 10 mm <sup>2</sup>		
Cross section, AWG	28 - 7		



## CRIMPING TOOL

• for ferrules

Description	Type	Part No.	Std. Pack
Pressing tool A	Length: 180 mm PW/A	95.101.1300.0	1
Pressing tool B	Length: 203 mm PW/B	95.101.1100.0	1
Pressing tool C	Length: 203 mm PW/C	95.101.1200.0	1
<b>GENERAL DATA</b>			
A: Wire strip length	0.08 - 10 mm <sup>2</sup>		
A: Cross section, AWG	28 - 7		
B: Wire strip length	10 - 25 mm <sup>2</sup>		
B: Cross section, AWG	7 - 4		
C: Wire strip length	35 - 50 mm <sup>2</sup>		
C: Cross section, AWG	2 - 1/0		





# TABLES, TECHNICAL DATA

## DIN RAIL TERMINAL BLOCKS

### MATERIAL SELECTION SELOS AND FASIS

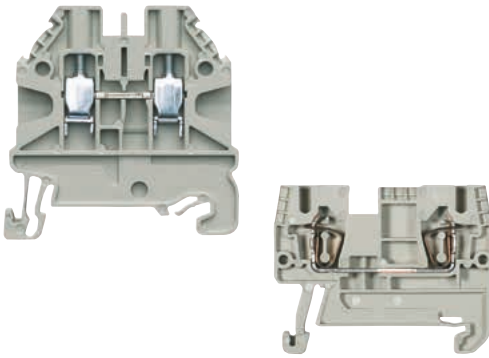

### METAL PARTS

- Special alloys enable low feed-through resistance and provide a gas-tight contact area:
  - Current carrying bar: Copper, or brass
  - Clamping body and clamping screws: Galvanized and chromated steel
  - Clamping spring: CrNi stainless steel
  - Current carrying bar: Copper, tinned

### PLASTIC MATERIALS

- Polyamide has excellent electrical, chemical and mechanical characteristics:
  - Temperature resistance: Up to 120°C
  - Creepage resistance: CTI 600
  - Flammability class: Self-extinguishing, UL94-V0

### ELECTRICAL AND THERMAL CHARACTERISTICS OF PLASTIC MATERIALS

Key figures / characteristics	Standard		Unit		Thermoplast Polyamide PA 666
Dielectric strength	VDE 0303-T21	IEC 243/1	kV / mm	tr./lf.	55 / 45
Dielectric loss tan $\delta$ at 1 MHz	VDE 0303-T4	IEC 250		tr./lf.	0.02 / 0.3
Specific feed through resistance	VDE 0303-T30	IEC 93	$\Omega \times \text{cm}$	lf.	$10^{12}$
Surface resistance	VDE 0303-T30	IEC 93	$\Omega$	lf.	$10^{10}$
Creepage	VDE 0303-T1	IEC 112	CTI		600
Operating temperature RTI *	UL 746 B		°C at 1.5 mm		120
Temperature index TI **	VDE 0304 T.21	IEC 216-1	°C		123 / 107
Minimum operating temperature without mechanical stress			°C		-40
Flammability	UL 94		Class / material thickness		V0 / 0.4
Suitability for tropical areas					good

\* electrical value      \*\* related to 50% strain resistance drop after 5,000/20,000 hours

### STANDARD CROSS SECTIONS OF ROUND COPPER CONDUCTORS AWG/METRIC

Metric size ISO mm <sup>2</sup>	Comparison between AWG/kcmil and metric sizes		
	AWG	kcmil	mm <sup>2</sup>
0.1*	28		0.081
0.14*	26		0.128
0.2	24		0.205
-	22		0.324
0.5	20		0.519
0.75	18		0.82
1	-		-
1.5	16		1.3
2.5	14		2.1
4	12		3.3
6	10		5.3
10	8		8.4

Metric size ISO mm <sup>2</sup>	Comparison between AWG/kcmil and metric sizes		
	AWG	kcmil	mm <sup>2</sup>
16	6		13.3
25	4		21.2
35	2		33.6
50	(1/0)	0	53.5
70	(2/0)	00	67.4
95	(3/0)	000	85
-	(4/0)	0000	107.2
120		250	127
150		300	152
185		350	177
240		500	253
300		600	304

\* not standardized

# MOUNTING RAILS

## MAXIMUM SHORT-TIME CURRENT CAPABILITY ASSIGNED TO MOUNTING RAILS

DIN EN 60 947-2

Rail profile	Material	Equivalent E-Cu cross section mm <sup>2</sup>	Short-time-current capability 1 s kA	Rated thermal current of a PEN busbar A
DIN rail TH 15 x 5,5 according to IEC 60 715	Steel	10	1.2	-
G rail TS 32 according to IEC 60 715	Steel	35	4.2	-
	Copper <sup>1)</sup>	120	14.4	269
	Aluminium <sup>1)</sup>	70	8.4	192
DIN rail TS 35 x 27 x 7,5 according to IEC 60 715	Steel	16	1.92	-
DIN rail TS 35 x 27 x 15 according to IEC 60 715	Steel	25	3	-
DIN rail TS 35 x 24 x 15 according to IEC 60 715 (made from 2.3 mm thick material)	Steel	50	6	-
	Copper <sup>1)</sup>	150	18	309

<sup>1)</sup> Selected copper or aluminum alloys from the manufacturer of the terminal block layout were used to achieve the values in the table.

## TORQUES

Torque according to EN 60947-1  
for selos DIN rail terminal blocks

II applies for screws that are tightened with a  
screwdriver

III applies for screws that can be tightened with  
tools other than a screwdriver

		II	III
<b>WT 2.5, width 5 mm</b>	M2.5 clamping body screw	Nm 0.4	
<b>WT 4 ... , width 6 mm</b>	M3 clamping body screw	Nm 0.5	
<b>WT 6 and WKN 6, width 8 mm</b>	M4 clamping body screw	Nm 1.2	
	M3.5 screw for cross connector	Nm 0.8	
<b>WT 10, width 10 mm</b>	M4 clamping body screw	Nm 1.2	
<b>WT 16, width 12 mm</b>	M5 clamping body screw	Nm 2.0	
<b>WKN 35, width 16 mm</b>	M6 clamping body screw	Nm 2.5	3.0
	M5 screw for cross connector	Nm 2.0	2.0
<b>WKN 70, width 24 mm</b>	M8 clamping body screw	Nm 3.5	6.0
	M6 screw for cross connector	Nm 2.5	3.0
<b>WKN 150, width 28 mm</b>	M10 clamping body screw	Nm 4.0	10.0
	M8 screw for cross connector	Nm 3.5	6.0



# INFORMATION ABOUT **EX** APPLICATIONS

## **DIN RAIL TERMINAL BLOCKS FOR INSTALLATIONS WITH EXPLOSION HAZARD (EX TERMINALS) PROTECTION CATEGORY INCREASED SAFETY “E”**

Ex terminals are DIN rail terminal blocks that have been tested and certified by a European Ex test institute according to

**EN 60 079-0 – VDE 0170/0171 part 1 “General requirements” and**

**EN 60 079-7 – VDE 0170/0171 part 6 Protection category: Increased safety “e”**

DIN EN 60079-0, VDE 0170-1: Explosionsfähige Atmosphäre - Teil 0: Geräte - Allgemeine Anforderungen (IEC 60079-0); Deutsche Fassung EN 60079-0

DIN EN 60079-7, VDE 0170-6: Explosionsfähige Atmosphäre - Teil 7: Geräteschutz durch erhöhte Sicherheit „e“ (IEC 60079-7); Deutsche Fassung EN 60079-7

The protection category Increased safety “e” applies to electrical equipment that resists sparks, electric arcing or hazardous surface temperatures during operation. DIN rail terminal blocks thus fall into temperature category T6 in which electrical equipment at an ambient temperature of 40 °C and proper use does not exceed the maximum temperature (surface temperature) of 85 °C.

Certifying test institutes are, for example, the Physikalisch Technische Bundesanstalt PTB in Germany, the Laboratoire Central des Industries Electrique LCIE in France, the Health and Safety Executive BASEEFA in Great Britain, the EX laboratory of ASEV in Switzerland, among others.

However, for DIN rail terminal blocks as incomplete electrical equipment, only a partial certification is issued.

This certificate is the basis for the final acceptance and certification of the complete installation before it is commissioned by an expert.

The certificate (prototype test certificate) includes a description of the DIN rail terminal blocks, in which special requirements regarding the preparation of terminal strips are put into place, for example, installing partitions and end plates when terminal blocks are connected in series. This information is also provided in our catalog that in this case serves as an instruction manual.

### **TEST CERTIFICATE**

Certificates from notified bodies are available for feed-through terminal blocks of series WK(N).., WKF.., WKFN.., WT and ground blocks of series WK(N)..SL.., WKF..SL.., WKFN..SL.., WT..PE as well as revos Ex industrial multipole connectors.

The certificates indicate the relevant rated values and include the accessories listed in the description.

The areas of application are divided into:

**Group I: Electrical equipment for mine openings with firedamp hazard**

**Group II: Electrical equipment for hazardous areas except for mine openings with firedamp hazard (for example installations with explosion hazard for the chemical and petrochemical industry).**

According to a resolution of the DEK (Deutsche Elektrotechnische Kommission) terminal blocks are also accepted as electrical equipment for Group I (firedamp protection Ex e I) for which only the increased safety protection type ‘e’ for Group II (explosion protection Ex e II) has been certified and vice versa.

Ex protected DIN rail terminal blocks are identified with distinct safety protection and an additional marking according to ATEX directive 2014/34/EU. The complete test certificate with a description is available on request or it can be downloaded from Wieland Electric Download Center.

### **PROTECTION CATEGORY “INTRINSIC SAFETY EX I”**

The DIN rail terminal blocks can be used in Group II (Category 2) and Group 1 (Category M2) equipment, as the standard requirements are identical in this case.

It has been generally accepted that feed-through terminals in intrinsic circuits are clearly marked with the blue coloring of the insulated housing. For intrinsic circuits, feed-through terminals can be used in the standard version and if required are available with blue insulating housing.



## TECHNICAL INFORMATION

- The information regarding cross sectional area and connection types pertains to unprepared wires without ferrules! Ferrules are not necessary for secure connection. Whenever ferrules are used, make sure that the tools specified by the manufacturer are used exclusively.
- The voltage ratings apply to the terminals in their intended application. When different products are mounted adjacent to each other, the proper isolation distances must be adhered to.
- If the ground blocks are not used in block assemblies, but are mounted to the rail as single terminal blocks, end clamps have to be used.
- A detailed description of technical data, the standards requirements, and the application conditions are available in the flyer facts & DATA.

## ATEX REGULATION

- For the use of DIN rail terminal blocks in Ex areas, the regulations of EN 60079-0 apply; whereas for increased safety Exe the regulations of EN 60079-7 must be followed. For an approximation of the laws of the EU member states, directive 2014/34/EU was created, which is generally known as ATEX 100a and which is the basis for harmonization in this field. ATEX stands for "atmosphere explosive" while 100a refers to the corresponding article of the EC contract.
- Directive ATEX 100a applies for protection against dust and gas explosions in all industrial Ex areas and in mining. The testing and certificating institutes named in directive ATEX 100a must follow accreditation procedures which are the same throughout Europe.
- In accordance with EN 60070-0/60079-7 and ATEX 100a, these certifying institutes write out EC certificates for prototype tests. These prototype test certificates for components together with the corresponding quality system certification of the supplier are required to obtain the so-called ATEX approval.
- In combination with the mark, the markings of the Wieland terminal blocks have the following meaning:

	Identification
II	Device group
2	Category
G D	Areas
KEMA	Name of testing institute
ATEX...	Certificate, year of testing, number

## MOUNTING INSTRUCTIONS FOR EX E APPLICATIONS

- If feed-through blocks are mounted directly adjacent to other feed-through blocks of a different size, or directly adjacent to ground blocks, the open side of the block group of the same type must be covered by an end plate or partition.
- If adjacent DIN rail terminal blocks are jumpered or if jumpered DIN rail terminal blocks are positioned next to unjumpered DIN rail terminal blocks, a partition plate must be inserted between the individual terminal block groups or at the beginning and end of a laterally or longitudinally connected terminal block (group) in order to meet the specified isolation distances. Notched out and jumpering cross connectors can not be used in Ex areas.
- If the terminal blocks are combined with other certified series and sizes and when their accessories are used, the required creepage distances and clearances must be adhered to.
- The feed through terminal blocks and protective conductor terminal blocks are suitable for enclosures for use in explosive gas atmospheres or for use in the presence of combustible dust. For explosive gas atmospheres these enclosures must satisfy the requirements of EN 60079-0 and EN 60079-7. For combustible dust these enclosures must satisfy the requirements of 60079-0 and EN 60079-31.
- If the DIN rail terminal blocks are installed in a housing with protection type "e" (increased safety) according to EN 60079-7, the clearances and creepage distances stated in Table 2 must be adhered to..
- The indicated values for the current carrying capability refer to a maximum ambient temperature of 40 °C. When the terminal blocks are loaded with the maximum rated current the temperature rise will be max. 45 K.
- Operating temperature range:
 

-40° C ... +80° C, series WK(N)/M..., WKF..., WT
-20° C ... +80° C, series WKFN
- If cables are used whose cross-section is smaller than the nominal cable cross-section, the corresponding lower current must be specified in the EC prototype test certificate for the complete device.
- Due to the heat generated during operation at the specified current and at ambient temperatures of ≤ 40 °C, the DIN rail terminal blocks can be installed in equipment (mainly distribution and connection boxes) suitable for temperature class T6. If DIN rail terminal blocks are installed in equipment with a temperature class ranging from T1 to T5, it must be ensured that the maximum temperature of the insulating parts does not exceed the maximum value in the operating temperature range.

## TEMPERATURE CLASSES

Temperature class	T1	T2	T3	T4	T5	T6
Maximum surface temperature at equipment in °C	450	300	200	135	120	85



# SCCR VALUES FOR DIN RAIL TERMINAL BLOCKS

NEC prescribes enhanced requirements relating to the short-circuit resistance of plants for operators and manufacturers of electrical plants. According to the rules of NEC 2005 paragraph 409.110, and in accordance with UL 508A, the short-circuit resistance of the entire switchgear must be examined. This must be documented on the nameplate of the control cabinet by indicating the plant's short circuit current rating.

Wieland has tested and determined individual SCCR values for their terminal blocks in connection with the widest variety of fuses. These ratings are far greater than the default values contained in UL 508A. As a result, when qualifying your installation, you have increased flexibility and accuracy when using Wieland terminal blocks.

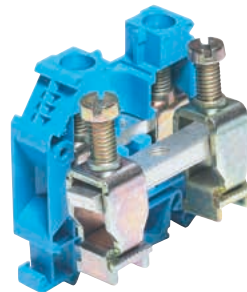
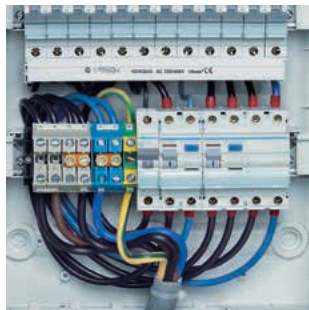
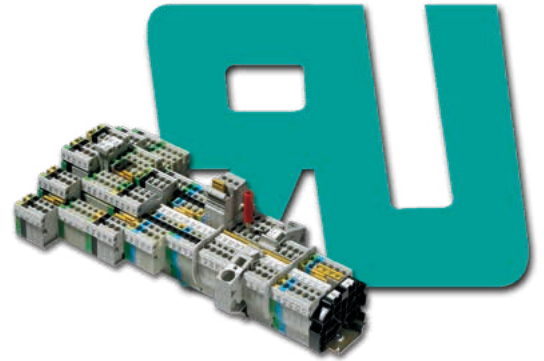

## WHAT DOES SCCR MARKING MEAN?

The Short Circuit Current Rating (SCCR) of a component represents the maximum short circuit current level a device can safely withstand without compromising safety for installations and personnel. Article 409 on industrial control panels was added to the NEC in the 2005 edition. This article calls for all industrial control panels to be marked with a Short Circuit Current Rating. The Short Circuit Current Rating (SCCR) requirements for UL 508A came into force in April 2006.

## HOW IS THE SCCR MARKING DETERMINED?

The NEC Article 409 refers to the UL 508A Supplement SB as an approved method for determining the SCCR of an industrial control panel. This specific method is outlined in Section SB4.

1. Determination of the SCCR values of individual components, for example DIN rail terminal blocks
2. Modification of the SCCR values through the use of current limiting devices per UL 508 SB 4.3
3. Selection of the lowest SCCR value from all the components

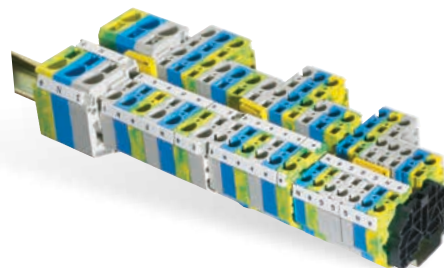
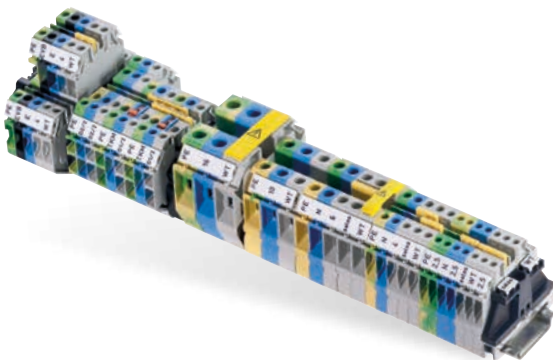

## SCCR FOR DIN RAIL TERMINAL BLOCKS IN GENERAL

The SCCR of a terminal block can be determined according to UL 508A using one of the following methods:

1. Use the tested SCCR value
2. Use the default SCCR value as specified in table 4.1 of UL 508

If the DIN rail terminal blocks do not have a tested SCCR, then the UL default value of 10 kA must be used. This relatively low value would limit the SCCR of the entire system to max. 10 kA.

## SCCR FOR WIELAND DIN RAIL TERMINAL BLOCKS

Wieland determined SCCR values for its DIN rail terminal blocks used in conjunction with fuses and circuit breakers. The resulting SCCR values are much higher than the values specified for DIN rail terminal blocks in table SB 4.1 of UL 508A.

You will find the tested SCCR values for our selos and fasis product series in our customer information 0019.3, available on [www.wieland-electric.com](http://www.wieland-electric.com).

The SCCR values are also published on the UL website (<http://www.ul.com>) under file number E60678.

# INDEX

PART NUMBER | PAGE



01.108.7653.0	153	04.343.5456.8	16	04.410.0481.0	158	04.841.1350.0	166
01.299.9753.0	169	04.343.5456.8	169	04.410.0581.0	158	04.841.1450.0	166
04.019.0289.0	152	04.343.6053.8	110	04.410.0681.0	158	04.841.1550.0	166
04.019.0289.0	152	04.343.6053.8	110	04.410.0781.0	158	04.841.1650.0	166
04.019.0289.0	153	04.343.6153.8	79	04.410.0881.0	158	04.841.1750.0	166
04.019.0289.0	153	04.343.6153.8	86	04.410.0981.0	158	04.841.1850.0	166
04.019.0289.0	167	04.343.6153.8	102	04.410.1081.2	158	04.841.1950.0	166
04.019.1189.0	152	04.343.6153.8	103	04.410.1081.8	158	04.841.2050.0	166
04.019.1189.0	153	04.343.6153.8	105	04.410.1281.2	158	04.841.2150.0	166
04.241.1150.0	166	04.343.6153.8	169	04.410.1481.8	159	04.841.2250.0	166
04.242.0850.0	164	04.343.6253.8	80	04.410.1581.0	159	04.841.2350.0	166
04.242.0950.0	167	04.343.6253.8	87	04.410.1681.2	159	04.841.2450.0	166
04.242.1250.0	167	04.343.6253.8	169	04.410.1781.0	159	04.841.2550.0	166
04.242.1553.0	164	04.343.6453.8	81	04.410.1881.2	159	04.841.2650.0	166
04.242.2853.0	167	04.343.6453.8	89	04.410.1981.0	159	04.841.2750.0	166
04.242.5053.0	164	04.343.6453.8	169	04.410.2081.2	159	04.841.2850.0	166
04.242.5153.0	164	04.343.6653.8	77	04.410.2081.8	159	04.841.2950.0	166
04.242.6053.0	165	04.343.6653.8	79	04.420.0181.2	160	04.841.3050.0	166
04.242.6353.0	165	04.343.6653.8	82	04.420.0181.8	160	04.841.3150.0	166
04.242.8053.0	165	04.343.6653.8	82	04.420.0381.2	160	04.841.3250.0	166
04.243.0755.0	93	04.343.6653.8	89	04.420.0481.2	160	04.841.3350.0	166
04.243.0855.0	95	04.343.6653.8	105	04.420.0581.2	160	04.841.3450.0	166
04.243.0855.0	97	04.343.6653.8	169	04.420.0681.2	160	04.841.3550.0	166
04.243.0855.0	138	04.343.6853.8	111	04.420.0781.0	161	04.841.3650.0	166
04.243.0855.0	138	04.343.6953.8	75	04.420.0781.2	161	04.841.3750.0	166
04.243.0953.0	90	04.343.6953.8	84	04.420.0781.8	161	04.841.3850.0	166
04.243.0953.0	90	04.343.6953.8	90	04.420.1081.0	161	04.841.3950.0	166
04.243.0953.0	90	04.343.6953.8	169	04.420.1081.2	161	04.841.4050.0	166
04.243.2053.0	164	04.343.8353.8	77	04.420.1081.8	161	04.841.4150.0	166
04.243.8550.0	152	04.343.8353.8	85	04.420.1281.0	161	04.841.4250.0	166
04.243.8550.0	153	04.343.8353.8	93	04.420.1281.2	161	04.841.4350.0	166
04.244.0053.0	118	04.343.8353.8	95	04.420.1381.0	161	04.841.4450.0	166
04.244.0053.0	119	04.343.8353.8	97	04.420.1481.2	161	04.841.4550.0	166
04.244.0053.0	121	04.343.8353.8	101	04.420.1581.2	160	04.841.4650.0	166
04.304.0181.0	53	04.343.8353.8	109	04.420.1581.8	160	04.841.4750.0	166
04.304.0181.0	53	04.343.8353.8	110	04.420.1681.2	160	04.841.4850.0	166
04.304.0281.0	53	04.343.8353.8	111	04.420.1681.8	160	04.841.4950.0	166
04.304.0281.0	53	04.343.8353.8	169	04.420.1781.2	160	04.841.5050.0	166
04.312.2056.0	35	04.343.9056.8	37	04.420.1781.8	160	04.841.5150.0	166
04.325.1056.0	65	04.343.9156.8	37	04.420.1881.2	160	04.841.5250.0	166
04.325.1156.0	66	04.343.9253.8	89	04.543.0056.0	164	04.841.5350.0	166
04.325.1256.0	66	04.343.9253.8	169	04.543.0156.0	164	04.841.5450.0	166
04.325.1356.0	67	04.344.1455.8	15	04.543.0256.0	164	04.841.5550.0	166
04.325.1456.0	67	04.344.1655.8	15	04.543.0356.0	164	04.841.5650.0	166
04.325.1656.0	65	04.344.1855.8	15	04.543.0456.0	164	04.841.5750.0	166
04.326.2053.8	24	04.344.1855.8	15	04.543.0556.0	164	04.841.5850.0	166
04.326.2053.8	29	04.344.2255.8	15	04.543.0656.0	164	04.841.5950.0	166
04.326.2053.8	37	04.344.2655.0	132	04.543.0756.0	164	04.841.6050.0	166
04.326.2153.8	39	04.344.2655.0	133	04.543.0856.0	164	04.841.6150.0	166
04.326.2253.8	46	04.344.2655.0	134	04.543.0956.0	164	04.841.6250.0	166
04.326.2353.8	46	04.344.2655.0	134	04.543.1056.0	164	04.841.6350.0	166
04.326.2553.8	16	04.344.2655.0	134	04.553.0056.0	164	04.841.6450.0	166
04.326.2653.8	16	04.400.0081.2	157	04.553.0156.0	164	04.841.6550.0	166
04.326.2953.8	56	04.400.0281.2	157	04.553.0256.0	164	04.841.6650.0	166
04.326.3053.8	56	04.400.0281.2	163	04.553.0356.0	164	04.841.6750.0	166
04.326.3053.8	57	04.403.0056.0	157	04.553.0456.0	164	04.841.6850.0	166
04.326.3053.8	57	04.405.0056.0	157	04.553.0556.0	164	04.841.6950.0	166
04.342.0556.0	29	04.405.1056.0	157	04.553.0656.0	164	04.841.7050.0	166
04.342.3556.0	36	04.405.1156.0	157	04.553.0756.0	164	04.841.7150.0	166
04.343.4756.8	24	04.405.1256.0	157	04.553.0856.0	164	04.841.7250.0	166
04.343.4956.8	46	04.406.0056.0	157	04.553.0956.0	164	04.841.7350.0	166
04.343.5056.8	46	04.406.0156.0	157	04.553.1056.0	164	04.841.7450.0	166
04.343.5256.8	16	04.408.0056.0	157	04.553.3156.0	164	04.841.7550.0	166
04.343.5256.8	169	04.410.0181.0	158	04.553.3256.0	164	04.841.7650.0	166
04.343.5356.8	16	04.410.0281.0	158	04.841.1150.0	166	04.841.7750.0	166
04.343.5356.8	169	04.410.0381.0	158	04.841.1250.0	166	04.841.9050.0	166

# INDEX

PART NUMBER | PAGE

04.841.9150.0	166	04.855.1053.0	164	05.561.6653.0	118	05.564.3855.0	109
04.841.9250.0	166	04.855.1153.0	167	05.561.6653.0	119	05.564.3855.0	137
04.842.0850.0	164	04.855.1253.0	167	05.561.6653.0	121	05.564.3855.0	139
04.842.1553.0	164	04.855.3153.0	164	05.561.6753.0	110	05.564.3855.0	170
04.842.4953.0	164	04.855.3253.0	164	05.561.6753.0	110	05.564.3955.0	77
04.842.5053.0	164	04.856.0053.0	165	05.561.6753.0	118	05.564.3955.0	85
04.842.5553.0	165	04.856.0153.0	165	05.561.6753.0	119	05.564.3955.0	93
04.842.5953.0	165	04.856.0253.0	165	05.561.6753.0	121	05.564.3955.0	95
04.842.6053.0	165	04.856.0353.0	165	05.561.8553.0	79	05.564.3955.0	97
04.842.6553.0	165	04.856.0453.0	165	05.561.8553.0	86	05.564.3955.0	101
04.842.7953.0	165	04.856.0553.0	165	05.561.8553.0	99	05.564.3955.0	109
04.842.8053.0	165	04.856.0653.0	165	05.561.8553.0	102	05.564.3955.0	137
04.842.8553.0	165	04.856.0753.0	165	05.561.8553.0	103	05.564.3955.0	139
04.842.8553.0	165	04.856.0853.0	165	05.561.8553.0	105	05.564.3955.0	170
04.843.2053.0	164	04.856.0953.0	165	05.561.8553.0	170	05.564.4253.0	75
04.844.2053.0	118	04.856.1053.0	165	05.561.8653.0	79	05.564.4253.0	84
04.844.2053.0	119	04.856.1153.0	167	05.561.8653.0	86	05.564.4253.0	90
04.844.2053.0	121	04.856.1253.0	167	05.561.8653.0	99	05.564.4253.0	170
04.844.2153.0	118	04.856.3153.0	165	05.561.8653.0	102	05.564.4353.0	75
04.844.2153.0	119	04.856.3253.0	165	05.561.8653.0	103	05.564.4353.0	84
04.844.2153.0	121	04.858.0053.0	165	05.561.8653.0	105	05.564.4353.0	90
04.844.2253.0	118	04.858.0153.0	165	05.561.8653.0	170	05.564.4353.0	170
04.844.2253.0	119	04.858.0253.0	165	05.561.8753.0	79	05.566.6855.9	43
04.844.2253.0	121	04.858.0353.0	165	05.561.8753.0	86	05.567.9155.0	109
04.845.0153.0	164	04.858.0453.0	165	05.561.8753.0	99	05.576.5853.0	36
04.845.0253.0	164	04.858.0553.0	165	05.561.8753.0	102	05.584.0053.0	36
04.845.0353.0	164	04.858.0653.0	165	05.561.8753.0	103	05.593.5953.0	66
04.845.0453.0	164	04.858.0753.0	165	05.561.8753.0	105	05.902.3500.0	118
04.845.0553.0	164	04.858.0853.0	165	05.561.8753.0	170	05.902.3500.0	119
04.845.0653.0	164	04.858.0953.0	165	05.561.9153.0	37	05.902.3500.0	121
04.845.0753.0	164	04.858.1053.0	165	05.562.2453.0	110	06.502.4000.0	77
04.845.0853.0	164	04.858.1153.0	167	05.562.2453.0	111	06.502.4000.0	79
04.845.0953.0	164	04.858.1253.0	167	05.562.2453.0	114	06.502.4000.0	85
04.845.1053.0	164	04.858.3153.0	165	05.562.2453.0	114	06.502.4000.0	86
04.846.0153.0	165	04.858.3253.0	165	05.562.2453.0	114	06.502.4000.0	95
04.846.0253.0	165	04.900.0000.0	167	05.562.2453.0	115	06.502.4000.0	101
04.846.0353.0	165	04.900.1053.0	167	05.562.2553.0	110	06.502.4000.0	102
04.846.0453.0	165	04.900.2053.0	167	05.562.2553.0	111	06.502.4000.0	103
04.846.0553.0	165	04.900.3053.0	167	05.562.2553.0	114	06.502.4000.0	105
04.846.0653.0	165	04.900.4053.0	167	05.562.2553.0	114	06.502.4000.0	109
04.846.0753.0	165	05.502.4000.0	170	05.562.2553.0	114	06.502.4000.0	109
04.846.0853.0	165	05.502.4000.0	170	05.562.2553.0	115	06.502.4000.0	111
04.846.0953.0	165	05.502.4100.0	170	05.562.2653.0	110	06.502.4000.0	114
04.846.1053.0	165	05.502.4100.0	170	05.562.2653.0	111	06.502.4000.0	114
04.848.0153.0	165	05.508.3121.0	66	05.562.2653.0	114	06.502.4000.0	114
04.848.0253.0	165	05.508.3221.0	66	05.562.2653.0	114	06.502.4000.0	115
04.848.0353.0	165	05.508.6521.0	67	05.562.2653.0	114	06.502.4000.0	117
04.848.0453.0	165	05.508.6521.0	67	05.562.2653.0	115	06.502.4000.0	118
04.848.0553.0	165	05.508.8821.0	65	05.563.5453.0	45	06.502.4000.0	119
04.848.0653.0	165	05.508.8921.0	65	05.564.0753.0	53	06.502.4000.0	121
04.848.0753.0	165	05.511.2953.0	45	05.564.3755.0	77	06.502.4000.0	137
04.848.0853.0	165	05.511.2953.6	45	05.564.3755.0	85	06.502.4000.0	139
04.848.0953.0	165	05.511.2953.7	45	05.564.3755.0	93	06.502.4000.0	170
04.848.1053.0	165	05.511.2953.8	45	05.564.3755.0	95	06.502.4000.0	170
04.855.0053.0	164	05.511.2953.9	45	05.564.3755.0	97	06.502.4100.0	80
04.855.0153.0	164	05.561.0053.0	36	05.564.3755.0	101	06.502.4100.0	87
04.855.0253.0	164	05.561.0053.0	36	05.564.3755.0	109	06.502.4100.0	141
04.855.0253.5	29	05.561.0053.0	111	05.564.3755.0	137	06.502.4100.0	170
04.855.0353.0	164	05.561.4125.0	37	05.564.3755.0	139	06.502.4200.0	77
04.855.0353.6	29	05.561.6553.0	110	05.564.3755.0	170	06.502.4200.0	79
04.855.0453.0	164	05.561.6553.0	110	05.564.3855.0	77	06.502.4200.0	81
04.855.0553.0	164	05.561.6553.0	118	05.564.3855.0	85	06.502.4200.0	83
04.855.0653.0	164	05.561.6553.0	119	05.564.3855.0	93	06.502.4200.0	89
04.855.0753.0	164	05.561.6553.0	121	05.564.3855.0	95	06.502.4200.0	105
04.855.0853.0	164	05.561.6653.0	110	05.564.3855.0	97	06.502.4200.0	170
04.855.0953.0	164	05.561.6653.0	110	05.564.3855.0	101	06.502.4200.0	170

# INDEX

PART NUMBER | PAGE



06.502.4200.0	170	07.201.8427.0	55	07.311.7955.0	16	07.312.6955.0	100
06.502.4300.0	75	07.201.9227.6	51	07.311.8155.0	31	07.312.6955.0	108
06.502.4300.0	84	07.201.9327.6	51	07.311.8155.0	33	07.312.6955.0	136
06.502.4300.0	132	07.205.1227.0	54	07.311.8353.0	126	07.312.6955.0	137
06.502.4300.0	133	07.205.1327.0	54	07.311.8353.0	126	07.312.6955.6	76
06.502.4300.0	135	07.205.1427.0	54	07.311.8353.0	126	07.312.6955.6	108
06.502.4300.0	170	07.205.5227.0	53	07.311.8353.0	127	07.312.7055.0	76
06.502.5000.0	77	07.205.5327.0	53	07.311.8855.0	61	07.312.7055.0	100
06.502.5000.0	79	07.205.7227.0	53	07.311.9055.0	36	07.312.7055.0	108
06.502.5000.0	85	07.205.7327.0	53	07.311.9155.0	36	07.312.7055.0	136
06.502.5000.0	86	07.205.8227.0	53	07.311.9455.0	61	07.312.7055.0	137
06.502.5000.0	95	07.205.8327.0	53	07.311.9455.0	61	07.312.7155.0	76
06.502.5000.0	101	07.205.9227.0	53	07.311.9855.0	36	07.312.7155.0	85
06.502.5000.0	102	07.205.9327.0	53	07.312.0053.0	68	07.312.7155.0	100
06.502.5000.0	103	07.257.0227.0	29	07.312.0153.0	68	07.312.7155.0	136
06.502.5000.0	105	07.257.0327.0	29	07.312.0253.0	68	07.312.7155.0	137
06.502.5000.0	109	07.257.2027.0	29	07.312.0353.0	69	07.312.7155.6	76
06.502.5000.0	109	07.300.6955.0	47	07.312.0453.0	43	07.312.7255.0	76
06.502.5000.0	117	07.300.7055.0	47	07.312.0453.0	45	07.312.7255.0	100
06.502.5000.0	137	07.310.3153.0	65	07.312.0453.0	46	07.312.7255.0	136
06.502.5000.0	139	07.310.3153.0	65	07.312.0453.0	46	07.312.7255.0	137
06.502.5000.0	170	07.310.3253.0	66	07.312.0453.0	47	07.312.7355.0	93
06.502.5000.0	170	07.310.3353.0	67	07.312.0453.0	47	07.312.7355.0	108
06.600.2027.0	171	07.310.3353.0	67	07.312.0555.0	28	07.312.7355.0	138
06.600.2127.0	171	07.310.3453.0	65	07.312.0555.0	28	07.312.7355.0	138
06.600.2227.0	171	07.310.3453.0	65	07.312.1255.0	27	07.312.7355.0	138
06.600.2327.0	171	07.310.3553.0	66	07.312.1255.0	27	07.312.7455.0	93
06.600.2427.0	171	07.310.3653.0	67	07.312.1555.0	36	07.312.7455.0	108
06.600.2527.0	171	07.310.3653.0	67	07.312.1655.0	36	07.312.7455.0	138
06.600.2627.0	171	07.310.3953.0	66	07.312.1755.0	24	07.312.7455.0	138
06.600.2727.0	171	07.310.4053.0	66	07.312.1855.0	24	07.312.7555.0	97
06.600.2827.0	171	07.310.5855.0	38	07.312.1955.0	60	07.312.7655.0	97
06.600.2927.0	171	07.310.9355.0	29	07.312.1955.0	60	07.312.7755.0	95
06.600.3027.0	171	07.310.9455.0	29	07.312.2153.0	124	07.312.7755.0	101
06.600.3127.0	171	07.311.0653.0	57	07.312.2153.0	124	07.312.7755.0	101
06.600.3227.0	171	07.311.0653.0	57	07.312.2253.0	124	07.312.7855.0	95
06.600.3327.0	171	07.311.0753.0	56	07.312.2253.0	124	07.312.7855.0	101
06.600.3427.0	171	07.311.0853.0	56	07.312.2953.0	119	07.312.7855.0	101
06.600.3527.0	171	07.311.0853.0	56	07.312.2953.0	121	07.312.8053.0	127
06.600.4027.0	171	07.311.0853.6	56	07.312.2953.6	119	07.312.8153.0	74
06.600.4127.0	171	07.311.0853.6	56	07.312.2953.6	121	07.312.8153.0	84
06.600.4227.0	171	07.311.1853.0	56	07.312.2953.9	119	07.312.8253.0	74
06.600.4327.0	171	07.311.1853.0	56	07.312.2953.9	121	07.312.8253.0	84
06.600.4427.0	171	07.311.2053.8	24	07.312.3153.0	118	07.312.8353.0	74
06.600.4527.0	171	07.311.2053.8	29	07.312.3153.6	118	07.312.8353.0	84
06.600.4627.0	171	07.311.2053.8	37	07.312.3153.9	118	07.312.8453.0	74
06.600.4727.0	171	07.311.2153.8	39	07.312.3553.0	111	07.312.8453.0	84
06.600.4827.0	171	07.311.2853.8	56	07.312.3653.0	111	07.312.8553.0	74
06.600.4927.0	171	07.311.2853.8	57	07.312.4153.0	110	07.312.8553.0	84
06.600.5027.0	171	07.311.2853.8	57	07.312.4153.0	110	07.312.8653.0	74
07.201.1227.6	50	07.311.2953.8	56	07.312.4153.6	110	07.312.8653.0	84
07.201.1327.6	50	07.311.3855.0	39	07.312.4753.0	110	07.312.8753.0	90
07.201.3227.6	50	07.311.4155.0	35	07.312.5653.0	123	07.312.8753.0	90
07.201.3327.6	50	07.311.4255.0	38	07.312.5953.0	117	07.312.8753.0	90
07.201.4227.0	54	07.311.4355.0	38	07.312.6053.0	15	07.312.8853.0	90
07.201.4227.0	55	07.311.4655.0	39	07.312.6053.0	169	07.312.8853.0	90
07.201.4327.0	54	07.311.6155.0	31	07.312.6755.0	76	07.312.8853.0	90
07.201.4327.0	55	07.311.6155.0	33	07.312.6755.0	85	07.312.8953.0	74
07.201.4427.0	54	07.311.6555.0	62	07.312.6755.0	136	07.312.8953.0	74
07.201.4427.0	55	07.311.6555.0	62	07.312.6755.0	137	07.312.8953.0	84
07.201.5227.6	50	07.311.6555.0	62	07.312.6755.6	76	07.312.8953.0	84
07.201.5327.6	50	07.311.6855.0	63	07.312.6855.0	76	07.312.9055.0	78
07.201.7227.6	51	07.311.6855.0	63	07.312.6855.0	136	07.312.9055.0	86
07.201.7327.6	51	07.311.6955.0	62	07.312.6855.0	137	07.312.9055.0	102
07.201.8227.0	55	07.311.6955.0	62	07.312.6955.0	76	07.312.9055.0	102
07.201.8327.0	55	07.311.7855.0	16	07.312.6955.0	85	07.312.9055.0	103



# INDEX

PART NUMBER | PAGE

07.312.9055.0	104	07.313.2555.0	19	07.431.7053.8	50	30.494.4121.0	149
07.312.9055.0	104	07.313.2655.0	15	07.431.7153.8	50	32.530.0053.0	53
07.312.9055.6	78	07.313.2755.0	15	07.431.7253.8	50	32.540.0053.0	53
07.312.9155.0	78	07.313.2755.0	19	07.431.7353.8	51	32.550.0053.0	53
07.312.9155.0	102	07.313.2855.0	15	07.431.7353.8	51	32.560.0053.0	53
07.312.9155.0	102	07.313.2855.0	22	25.320.0253.0	37	37.702.7453.0	114
07.312.9155.0	103	07.313.2855.0	22	25.320.1653.0	37	37.702.7553.0	114
07.312.9155.0	104	07.313.2855.0	23	25.320.3253.0	37	37.702.7653.0	115
07.312.9155.0	104	07.313.2855.0	23	25.320.4653.0	37	37.702.8453.0	114
07.312.9255.0	78	07.313.2855.0	23	25.325.0253.0	37	37.702.8553.0	114
07.312.9255.0	86	07.313.2855.0	25	25.325.1653.0	37	37.702.8653.0	115
07.312.9255.6	78	07.313.2855.0	25	25.325.3253.0	37	37.703.0553.0	118
07.312.9355.0	78	07.313.2955.0	22	25.325.4653.0	37	37.703.0553.6	118
07.312.9455.0	78	07.313.2955.0	23	25.360.0253.0	37	37.703.0553.9	118
07.312.9455.0	86	07.313.2955.0	23	25.360.1253.0	37	37.703.1053.0	118
07.312.9455.6	78	07.313.2955.0	23	25.360.3253.0	37	37.703.1053.6	118
07.312.9555.0	78	07.313.3155.0	22	25.360.4253.0	37	37.703.1053.9	118
07.312.9655.0	99	07.313.3355.0	25	25.920.0253.0	111	38.703.0553.0	119
07.312.9755.0	99	07.313.3355.0	25	25.920.0353.0	111	38.703.0553.6	119
07.313.0055.0	100	07.313.3355.0	25	25.920.0453.0	111	38.703.0553.9	119
07.313.0055.0	108	07.313.3355.0	26	25.920.0553.0	111	38.703.1053.0	119
07.313.0155.0	100	07.313.4155.0	140	25.920.0653.0	111	38.703.1053.6	119
07.313.0155.0	108	07.313.4155.0	141	25.920.0753.0	111	38.703.1053.9	119
07.313.0253.0	142	07.313.4255.0	140	25.920.0853.0	111	39.703.0153.0	118
07.313.0253.0	142	07.313.4255.0	141	25.920.0953.0	111	39.703.0153.6	118
07.313.0253.0	142	07.313.4355.0	60	25.920.1053.0	111	39.703.0153.9	118
07.313.0253.0	143	07.313.4455.0	132	25.920.1153.0	111	39.703.0253.0	118
07.313.0353.0	143	07.313.4455.0	133	25.920.1253.0	111	39.703.0253.6	118
07.313.0455.0	80	07.313.4555.0	132	25.920.1353.0	111	39.703.0253.9	118
07.313.0455.0	87	07.313.4555.0	133	25.920.1453.0	111	54.003.7553.0	65
07.313.0455.6	80	07.313.4655.0	132	25.920.1553.0	111	54.003.7553.6	65
07.313.0555.0	80	07.313.4655.0	133	25.920.1653.0	111	54.004.7553.0	65
07.313.0655.0	80	07.313.4755.0	134	25.920.3253.0	111	54.004.7553.6	65
07.313.0655.6	80	07.313.4755.0	134	25.920.3353.0	111	54.010.7553.0	66
07.313.0755.0	80	07.313.4855.0	135	25.920.3453.0	111	54.010.7553.6	66
07.313.0855.0	81	07.313.4855.0	135	25.920.3553.0	111	54.016.7553.0	66
07.313.0855.0	88	07.313.4855.0	135	25.920.3653.0	111	54.016.7553.6	66
07.313.0855.6	81	07.313.4955.0	132	25.920.3753.0	111	54.025.7553.0	67
07.313.0955.0	81	07.313.4955.0	133	25.920.3853.0	111	54.025.7553.6	67
07.313.1055.0	81	07.313.4955.0	133	25.920.3953.0	111	54.035.7553.0	67
07.313.1055.0	88	07.313.5155.0	92	25.920.4053.0	111	54.035.7553.6	67
07.313.1055.6	81	07.313.5155.0	92	25.920.4153.0	111	54.035.7553.9	67
07.313.1155.0	81	07.313.5155.0	92	25.920.4253.0	111	55.503.1053.0	56
07.313.1255.0	82	07.313.5255.0	140	25.920.4353.0	111	55.503.1053.6	56
07.313.1255.0	82	07.313.5255.0	140	25.920.4453.0	111	55.503.1253.0	57
07.313.1255.0	88	07.313.5255.0	141	25.920.4553.0	111	55.503.1353.0	57
07.313.1255.6	82	07.313.5255.0	141	25.920.4653.0	111	55.504.1053.0	56
07.313.1355.0	82	07.313.5355.0	140	25.920.4653.0	111	55.504.1053.6	56
07.313.1455.0	82	07.313.5355.0	141	30.494.3021.6	60	55.504.9153.0	56
07.313.1455.0	89	07.313.5355.0	141	30.494.3021.6	60	55.703.0053.0	117
07.313.1455.6	82	07.313.5455.0	140	30.494.3021.6	60	55.703.0053.6	117
07.313.1555.0	82	07.313.5455.0	141	30.494.3021.6	123	55.703.0553.0	120
07.313.1655.0	102	07.313.5555.0	132	30.494.3021.6	123	55.703.0553.6	120
07.313.1655.0	104	07.313.5555.0	132	30.494.3021.6	123	55.703.0553.7	120
07.313.1655.0	104	07.313.5555.0	133	30.494.4021.1	149	55.703.0553.9	120
07.313.1755.0	43	07.313.5555.0	133	30.494.4021.6	60	55.703.1053.0	120
07.313.2255.0	47	07.313.5555.0	134	30.494.4021.6	60	55.703.1053.6	120
07.313.2355.0	46	07.313.5555.0	134	30.494.4021.6	60	55.703.1053.7	120
07.313.2455.0	46	07.313.5555.0	134	30.494.4021.6	123	55.703.1053.9	120
07.313.2555.0	14	07.340.0353.0	54	30.494.4021.6	123	55.703.9053.0	117
07.313.2555.0	14	07.340.1053.0	54	30.494.4021.6	123	56.004.9053.0	68
07.313.2555.0	14	07.340.1053.0	55	30.494.4121.0	60	56.010.9053.0	68
07.313.2555.0	14	07.340.1053.0	55	30.494.4121.0	60	56.016.9053.0	68
07.313.2555.0	15	07.340.1053.0	55	30.494.4121.0	60	56.035.9053.0	69
07.313.2555.0	18	07.340.3553.0	53	30.494.4121.0	60	56.106.0055.0	43
07.313.2555.0	18	07.340.3653.0	53	30.494.4121.0	123	56.106.0155.0	43
07.313.2555.0	18	07.340.3753.0	53	30.494.4121.0	123	56.106.0553.0	45
07.313.2555.0	18	07.340.3753.0	53	30.494.4121.0	123		

# INDEX

PART NUMBER | PAGE



56.106.0653.0	45	56.399.0155.0	55	56.703.5055.0	76	56.704.7555.9	99
56.106.0755.0	43	56.399.0255.0	55	56.703.5055.6	76	56.704.7655.0	98
56.106.0855.0	43	56.399.1055.0	55	56.703.5155.0	76	56.704.7755.0	99
56.135.1055.0	50	56.399.1255.0	55	56.703.5155.6	76	56.704.7855.0	99
56.170.1055.0	50	56.404.8855.0	63	56.703.5355.0	100	56.704.7955.5	99
56.197.1055.0	50	56.404.9155.0	63	56.703.5455.0	100	56.704.8055.9	99
56.198.1055.0	51	56.404.9255.0	62	56.703.5555.0	100	56.704.8153.0	123
56.199.1055.0	51	56.404.9455.0	62	56.703.5955.1	94	56.704.8255.5	99
56.202.0055.0	132	56.404.9555.0	62	56.703.6055.0	94	56.704.8355.5	99
56.202.0055.6	132	56.404.9655.0	62	56.703.6155.0	95	56.704.8453.0	97
56.202.5055.0	132	56.404.9755.0	62	56.703.6255.0	94	56.704.9053.0	124
56.202.5055.6	132	56.404.9855.0	62	56.703.6355.0	94	56.704.9055.0	86
56.202.5155.0	132	56.503.7355.0	28	56.703.6455.0	95	56.704.9155.0	86
56.202.5155.6	132	56.503.7455.0	28	56.703.6555.0	101	56.704.9255.0	98
56.202.6955.1	134	56.503.7555.0	28	56.703.6655.0	101	56.704.9355.0	86
56.202.7055.0	134	56.503.7655.0	28	56.703.6955.1	91	56.704.XX55.5	99
56.202.8055.0	135	56.503.8355.0	27	56.703.7055.0	91	56.704.XX55.9	99
56.202.8155.0	135	56.503.8455.0	27	56.703.7155.5	93	56.706.0053.0	124
56.202.8255.0	135	56.503.8555.0	27	56.703.7155.9	93	56.706.0053.6	124
56.202.9055.0	133	56.510.9255.0	61	56.703.7355.5	93	56.706.0055.0	80
56.202.9155.0	133	56.516.9255.0	61	56.703.7555.5	93	56.706.0055.6	80
56.202.9255.0	134	56.535.9255.0	61	56.703.7555.9	93	56.706.5055.0	80
56.202.9355.0	133	56.702.0053.0	74	56.703.7655.0	91	56.706.5055.6	80
56.202.9555.0	135	56.702.0053.6	74	56.703.7755.0	93	56.706.9053.0	124
56.202.9655.0	135	56.702.2053.0	110	56.703.7855.0	93	56.706.9055.0	87
56.203.0055.0	136	56.702.5053.0	74	56.703.7955.5	93	56.706.9355.0	87
56.203.0055.6	136	56.702.5053.6	74	56.703.8155.9	93	56.710.0053.0	125
56.203.5055.0	136	56.702.5153.0	74	56.703.8255.5	93	56.710.0053.6	125
56.203.5055.6	136	56.702.5153.6	74	56.703.8355.5	93	56.710.0055.0	81
56.203.5155.0	136	56.702.6953.1	90	56.703.8653.0	127	56.710.0055.0	83
56.203.5155.6	136	56.702.7053.0	111	56.703.8855.0	96	56.710.0055.6	81
56.203.6955.1	138	56.702.7653.0	90	56.703.8955.0	91	56.710.0055.6	83
56.203.7055.0	138	56.702.9053.0	84	56.703.9053.0	124	56.710.5055.0	81
56.203.8553.0	143	56.702.9153.0	84	56.703.9055.0	85	56.710.5055.0	83
56.203.8653.0	143	56.702.9253.0	90	56.703.9155.0	85	56.710.5055.6	81
56.203.8953.0	142	56.702.9353.0	84	56.703.9253.0	110	56.710.5055.6	83
56.203.8955.0	138	56.703.0053.0	124	56.703.9355.0	85	56.710.8153.0	123
56.203.9055.0	137	56.703.0053.6	124	56.703.9453.0	126	56.710.9053.0	125
56.203.9155.0	137	56.703.0055.0	76	56.703.9553.0	127	56.710.9055.0	88
56.203.9355.0	137	56.703.0055.6	76	56.703.9653.0	126	56.710.9355.0	88
56.203.9453.0	142	56.703.0553.0	121	56.703.9753.0	126	56.716.0053.0	125
56.203.9553.0	143	56.703.0553.6	121	56.703.9853.0	126	56.716.0053.6	125
56.203.9653.0	142	56.703.0553.7	121	56.703.9953.0	126	56.716.0055.0	82
56.203.9753.0	142	56.703.0553.9	121	56.703.XX55.5	93	56.716.0055.6	82
56.203.9853.0	142	56.703.1053.0	121	56.703.XX55.9	93	56.716.0353.0	77
56.206.0055.0	140	56.703.1053.6	121	56.704.0053.0	124	56.716.0353.0	79
56.206.0055.6	140	56.703.1053.7	121	56.704.0053.6	124	56.716.0353.0	105
56.206.5055.0	140	56.703.1053.9	121	56.704.0055.0	78	56.716.1155.0	125
56.206.5055.6	140	56.703.2053.0	110	56.704.0055.6	78	56.716.1155.6	125
56.206.5155.0	140	56.703.2053.6	110	56.704.4055.0	102	56.716.5055.0	82
56.206.5155.6	140	56.703.2155.0	108	56.704.4055.0	102	56.716.5055.6	82
56.206.9055.0	141	56.703.2155.6	108	56.704.4055.0	103	56.716.8155.0	123
56.206.9155.0	141	56.703.2255.0	108	56.704.4055.0	103	56.716.9053.0	125
56.206.9355.0	141	56.703.2355.0	108	56.704.4155.0	104	56.716.9055.0	88
56.395.0055.0	54	56.703.2355.6	108	56.704.4255.0	104	56.716.9155.0	125
56.395.0155.0	54	56.703.2455.0	108	56.704.5055.0	78	56.716.9355.0	89
56.395.0255.0	54	56.703.2955.1	96	56.704.5055.6	78	56.735.0053.0	82
56.395.1055.0	54	56.703.3055.0	96	56.704.5155.0	78	56.735.0053.0	83
56.395.1255.0	54	56.703.3255.0	97	56.704.5155.6	78	56.735.0053.6	82
56.397.0055.0	54	56.703.3355.0	97	56.704.5355.0	104	56.735.0053.6	83
56.397.0155.0	54	56.703.3455.0	108	56.704.6955.1	98	56.735.9053.0	89
56.397.0255.0	54	56.703.3555.1	108	56.704.7055.0	98	57.016.5055.0	47
56.397.1255.0	54	56.703.3655.0	108	56.704.7155.5	99	57.106.1055.0	47
56.398.0055.0	55	56.703.4755.0	92	56.704.7155.9	99	57.106.1155.0	47
56.398.1055.0	55	56.703.4855.1	92	56.704.7355.5	99	57.110.1555.0	41
56.399.0055.0	55	56.703.4955.0	92	56.704.7555.5	99	57.110.1655.0	41

# INDEX

PART NUMBER | PAGE

57.403.6955.1	24	57.904.0755.0	40	58.504.7055.6	25	95.502.0627.0	163
57.403.7055.0	24	57.904.0855.0	40	58.504.7255.9	26	95.502.0628.0	163
57.503.2055.0	36	57.904.0955.0	40	58.504.7355.9	26	95.502.0700.0	163
57.503.2155.0	36	57.904.1055.0	40	58.504.7455.9	26	95.502.0710.0	163
57.503.2255.0	36	57.904.1155.0	40	58.504.7955.9	26	95.502.0710.2	163
57.503.2355.0	36	57.904.2055.0	40	58.504.8055.9	26	95.502.0710.3	163
57.503.2555.6	36	57.904.2555.0	40	58.504.8155.9	26	95.502.0710.4	163
57.503.2655.0	36	57.904.2855.0	40	58.504.8255.9	26	95.502.0710.5	163
57.503.2755.0	36	57.904.3955.0	40	58.504.8355.9	26	95.502.0710.7	163
57.503.2855.0	36	57.904.4155.0	40	58.504.8755.9	26	95.502.0711.0	163
57.503.3055.6	36	57.904.4255.0	40	58.504.8855.9	26	95.503.0000.0	156
57.503.7055.0	29	57.904.4355.0	40	58.504.9055.0	18	95.503.0004.0	156
57.503.7155.0	29	57.904.4455.0	40	58.504.9155.0	22	95.503.0005.0	156
57.503.7255.0	29	57.904.4555.0	40	58.504.9255.0	25	95.503.0006.0	156
57.503.7855.0	28	57.904.4655.0	40	58.504.9355.0	22	95.503.0010.1	156
57.503.7955.0	28	57.904.4755.0	40	58.504.XX55.9	26	95.503.0010.5	156
57.503.8055.0	28	57.904.4855.0	40	58.506.0055.0	14	95.503.0012.0	156
57.503.8855.0	27	57.904.4955.0	40	58.506.0055.6	14	95.503.0013.0	156
57.503.8955.0	27	57.904.5055.0	40	58.506.9055.0	18	95.503.0014.0	156
57.503.9055.0	27	57.904.5155.0	40	58.510.0055.0	15	98.090.0000.0	151
57.504.1655.0	32	57.904.5355.0	34	58.510.0055.6	15	98.090.0015.0	151
57.504.1755.0	32	57.904.5455.0	34	58.510.9055.0	19	98.190.0000.0	151
57.504.2055.0	32	57.904.5555.0	34	58.516.0055.0	15	98.190.1000.0	151
57.504.2055.6	32	57.904.5655.0	34	58.516.0055.6	15	98.210.0000.0	151
57.504.2355.0	32	57.904.5755.0	34	58.516.9055.0	19	98.220.0000.0	151
57.504.3655.0	39	57.904.5855.0	34	59.903.0155.0	109	98.290.0000.0	60
57.504.3755.0	39	57.904.6355.0	34	59.903.0255.0	109	98.290.0000.0	60
57.504.4055.0	30	57.904.6455.0	34	59.903.0355.0	109	98.290.0000.0	60
57.504.4055.0	30	57.904.6555.0	34	59.903.0455.0	109	98.290.0000.0	62
57.504.4055.0	31	57.904.6655.0	34	59.903.0555.0	109	98.290.1000.0	60
57.504.4055.0	31	57.904.6755.0	34	59.903.0655.0	109	98.290.1000.0	60
57.504.4455.0	33	57.904.6855.0	34	59.903.0755.0	109	98.290.1000.0	60
57.504.4555.0	33	57.904.7055.0	40	59.903.0855.0	109	98.290.1000.0	62
57.504.4855.0	33	57.904.7155.0	40	59.903.0955.0	109	98.290.1000.0	123
57.504.6255.0	38	57.904.7255.0	40	59.903.1055.0	109	98.290.1000.0	123
57.504.6355.0	38	57.904.7355.0	40	69.700.0953.0	115	98.290.1000.0	123
57.504.7355.0	38	57.904.7455.0	40	69.700.1853.0	115	98.290.1000.0	126
57.506.0555.0	46	57.910.5055.0	35	69.920.0553.0	152	98.290.1000.0	126
57.510.0555.0	46	57.910.5155.0	35	69.920.0653.0	153	98.290.1000.0	126
57.510.1155.0	61	57.910.5255.0	35	69.920.0753.0	153	98.290.1000.0	127
57.510.1155.6	61	57.910.5355.0	35	69.920.1053.0	152	98.290.1000.0	142
57.510.8255.0	60	57.910.5455.0	35	69.920.1253.0	152	98.290.1000.0	142
57.516.1155.0	61	57.910.5755.0	35	95.101.1100.0	171	98.290.1000.0	142
57.516.1155.6	61	57.910.5855.0	35	95.101.1200.0	171	98.290.1000.0	143
57.516.8255.0	60	57.910.6155.0	35	95.101.1300.0	171	98.290.1000.0	149
57.535.0155.0	16	58.503.0055.0	14	95.300.0500.0	170	98.300.0000.0	150
57.535.0155.6	16	58.503.0055.6	14	95.350.0100.0	171	98.300.0010.0	150
57.535.1155.0	61	58.503.2055.0	23	95.502.0100.0	163	98.300.1000.0	150
57.535.1155.6	61	58.503.2055.6	23	95.502.0118.0	163	98.360.0000.0	150
57.535.9055.0	20	58.503.2155.0	23	95.502.0125.0	163	98.360.0004.0	150
57.570.0155.0	16	58.503.2155.6	23	95.502.0125.1	163	98.370.0000.0	150
57.570.0155.6	16	58.503.2355.0	23	95.502.0135.0	163	98.370.1000.0	150
57.570.9055.0	20	58.503.9055.0	18	95.502.0135.1	163	98.370.1001.0	150
57.570.9855.0	17	58.504.0055.0	14	95.502.0150.0	163	98.375.1000.0	150
57.570.9955.0	17	58.504.0055.6	14	95.502.0170.0	163	98.380.0000.0	150
57.597.0155.0	16	58.504.2055.0	23	95.502.0197.0	163	98.400.0000.0	148
57.597.0155.6	16	58.504.2055.6	23	95.502.0198.0	163	99.013.9999.9	168
57.597.9855.0	17	58.504.2355.0	23	95.502.0199.0	163	99.014.9999.9	168
57.597.9955.0	17	58.504.4155.0	23	95.502.0225.1	163	99.015.9999.9	168
57.904.0055.0	40	58.504.5055.0	22	95.502.0235.1	163	99.031.9999.9	168
57.904.0155.0	40	58.504.5055.6	22	95.502.0604.0	163	99.032.9999.9	168
57.904.0255.0	40	58.504.5155.0	22	95.502.0607.0	163	99.033.9999.9	168
57.904.0355.0	40	58.504.5155.6	22	95.502.0612.0	163	99.034.9999.9	168
57.904.0455.0	40	58.504.6155.0	60	95.502.0613.0	163	Z1.108.8453.0	153
57.904.0555.0	40	58.504.6955.1	25	95.502.0620.0	163	Z1.110.8855.0	109
57.904.0655.0	40	58.504.7055.0	25	95.502.0625.0	163	Z1.110.8855.6	109

# INDEX

PART NUMBER | PAGE



Z1.110.8855.7	109	Z2.803.5310.0	148	Z7.211.0327.0	62	Z7.255.0227.0	168
Z1.110.8955.0	109	Z2.803.6010.0	148	Z7.211.0327.0	63	Z7.255.4227.0	31
Z1.110.8955.6	109	Z2.803.6110.0	148	Z7.211.0327.0	65	Z7.255.4227.0	33
Z1.110.8955.7	109	Z2.803.6210.0	148	Z7.211.0427.0	65	Z7.255.4227.0	168
Z1.110.9055.0	109	Z4.242.5053.0	163	Z7.211.0527.0	62	Z7.255.4227.0	168
Z1.110.9055.6	109	Z4.242.5153.0	163	Z7.211.0527.0	62	Z7.255.4327.0	31
Z1.110.9055.7	109	Z4.242.6053.0	163	Z7.211.0527.0	63	Z7.255.4327.0	33
Z1.298.1053.0	30	Z4.242.6353.0	163	Z7.211.0527.0	65	Z7.255.4627.0	31
Z1.298.1053.0	102	Z4.242.8053.0	163	Z7.211.0627.0	38	Z7.255.4627.0	33
Z1.298.1153.0	30	Z4.243.2053.0	163	Z7.211.0627.0	65	Z7.255.8227.0	43
Z1.298.1153.0	102	Z4.243.2053.0	164	Z7.212.0227.0	66	Z7.255.8227.0	168
Z1.298.1253.0	30	Z4.243.8453.0	152	Z7.212.0327.0	66	Z7.255.8327.0	43
Z1.298.1253.0	102	Z4.243.8453.0	153	Z7.212.0427.0	66	Z7.255.8327.0	168
Z1.298.1353.0	30	Z5.511.3553.0	43	Z7.212.0527.0	66	Z7.255.8427.0	43
Z1.298.1353.0	102	Z5.511.3553.6	43	Z7.212.0627.0	66	Z7.255.8527.0	43
Z1.298.1653.0	30	Z5.511.3553.7	43	Z7.212.1227.0	45	Z7.255.8627.0	43
Z1.298.1653.0	102	Z5.511.3553.8	43	Z7.212.1327.0	45	Z7.256.8427.0	168
Z1.298.1753.0	30	Z5.511.3553.9	43	Z7.212.1427.0	45	Z7.256.8527.0	168
Z1.298.1753.0	102	Z5.515.3310.0	149	Z7.212.1527.0	45	Z7.256.8527.0	168
Z1.298.1853.0	30	Z5.515.3410.0	149	Z7.212.2027.0	45	Z7.260.0029.0	117
Z1.298.1853.0	102	Z5.516.2511.0	151	Z7.212.2227.0	45	Z7.260.0229.0	117
Z1.298.1953.0	30	Z5.516.2711.0	151	Z7.212.2327.0	45	Z7.260.0329.0	117
Z1.298.1953.0	102	Z5.516.2811.0	151	Z7.212.2427.0	45	Z7.260.0429.0	117
Z1.298.2053.0	102	Z5.519.0310.0	149	Z7.213.0227.0	67	Z7.260.0529.0	117
Z1.299.3055.0	31	Z5.519.0410.0	149	Z7.213.0327.0	67	Z7.260.1029.0	117
Z1.299.3055.0	103	Z5.522.5010.0	153	Z7.213.0427.0	67	Z7.261.1127.0	93
Z1.299.3155.0	31	Z5.522.7553.0	153	Z7.213.0527.0	67	Z7.261.1127.0	95
Z1.299.3155.0	103	Z5.522.8553.0	152	Z7.213.0627.0	67	Z7.261.1127.0	97
Z1.299.3255.0	31	Z5.523.5653.0	153	Z7.214.0227.0	66	Z7.261.1127.0	99
Z1.299.3255.0	103	Z5.523.5753.0	153	Z7.214.0327.0	66	Z7.261.1127.0	168
Z1.299.3355.0	31	Z5.523.9353.0	152	Z7.214.0427.0	66	Z7.261.1227.0	14
Z1.299.3355.0	103	Z5.523.9453.0	152	Z7.214.0527.0	66	Z7.261.1227.0	22
Z1.299.4055.0	31	Z5.553.2921.0	77	Z7.214.0627.0	66	Z7.261.1227.0	22
Z1.299.4055.0	63	Z5.553.2921.0	79	Z7.215.0027.0	65	Z7.261.1227.0	23
Z1.299.4055.0	103	Z5.553.2921.0	80	Z7.215.0227.0	65	Z7.261.1227.0	23
Z1.299.4155.0	31	Z5.553.2921.0	81	Z7.215.0327.0	65	Z7.261.1227.0	25
Z1.299.4155.0	63	Z5.553.2921.0	83	Z7.215.0427.0	65	Z7.261.1227.0	25
Z1.299.4155.0	103	Z5.553.2921.0	86	Z7.215.0527.0	65	Z7.261.1227.0	79
Z1.299.4255.0	31	Z5.553.2921.0	87	Z7.215.0627.0	65	Z7.261.1227.0	99
Z1.299.4255.0	63	Z5.553.2921.0	89	Z7.215.4027.0	56	Z7.261.1227.0	102
Z1.299.4255.0	103	Z5.553.2921.0	89	Z7.215.4027.0	57	Z7.261.1227.0	103
Z1.299.9753.0	15	Z5.553.2921.0	95	Z7.215.4027.0	57	Z7.261.1227.0	105
Z1.299.9753.0	77	Z5.553.2921.0	101	Z7.215.4227.0	56	Z7.261.1227.0	123
Z1.299.9753.0	79	Z5.553.2921.0	102	Z7.215.4227.0	57	Z7.261.1227.0	124
Z1.299.9753.0	95	Z5.553.2921.0	103	Z7.215.4227.0	57	Z7.261.1227.0	168
Z1.299.9753.0	101	Z5.553.2921.0	137	Z7.215.4327.0	56	Z7.261.1327.0	14
Z1.299.9753.0	109	Z5.553.2921.0	139	Z7.215.4327.0	57	Z7.261.1327.0	22
Z1.299.9753.0	137	Z5.553.2921.0	141	Z7.215.4327.0	57	Z7.261.1327.0	22
Z1.299.9753.0	139	Z5.553.2921.0	169	Z7.215.4627.0	56	Z7.261.1327.0	25
Z1.299.9753.0	169	Z5.553.2921.1	169	Z7.215.4627.0	57	Z7.261.1327.0	25
Z1.980.0040.0	148	Z5.553.2921.6	169	Z7.215.4627.0	57	Z7.261.1327.0	79
Z1.980.0253.0	149	Z5.553.3021.0	169	Z7.216.0227.0	67	Z7.261.1327.0	99
Z2.302.0421.0	21	Z7.211.0027.0	62	Z7.216.0327.0	67	Z7.261.1327.0	102
Z2.302.0621.0	21	Z7.211.0027.0	62	Z7.216.0427.0	67	Z7.261.1327.0	103
Z2.302.1321.0	148	Z7.211.0027.0	62	Z7.216.0527.0	67	Z7.261.1327.0	105
Z2.803.3010.0	148	Z7.211.0027.0	63	Z7.216.0627.0	67	Z7.261.1327.0	123
Z2.803.3110.0	148	Z7.211.0027.0	63	Z7.220.0227.0	38	Z7.261.1327.0	124
Z2.803.3210.0	148	Z7.211.0027.0	65	Z7.220.0227.0	38	Z7.261.1327.0	168
Z2.803.3310.0	148	Z7.211.0227.0	38	Z7.220.0627.0	38	Z7.261.1427.0	14
Z2.803.4010.0	148	Z7.211.0227.0	62	Z7.250.5227.0	47	Z7.261.1427.0	22
Z2.803.4110.0	148	Z7.211.0227.0	62	Z7.250.5227.0	47	Z7.261.1427.0	22
Z2.803.4210.0	148	Z7.211.0227.0	62	Z7.250.5327.0	47	Z7.261.1427.0	25
Z2.803.4310.0	148	Z7.211.0227.0	63	Z7.250.5327.0	47	Z7.261.1427.0	25
Z2.803.5010.0	148	Z7.211.0227.0	63	Z7.250.5427.0	47	Z7.261.1427.0	79
Z2.803.5110.0	148	Z7.211.0227.0	65	Z7.250.5427.0	47	Z7.261.1427.0	99
Z2.803.5210.0	148	Z7.211.0327.0	38	Z7.255.0227.0	168	Z7.261.1427.0	102

# INDEX

PART NUMBER | PAGE

Z7.261.1427.0	103	Z7.267.1227.6	28	Z7.280.6227.0	127	Z7.280.6627.0	168
Z7.261.1427.0	105	Z7.268.0227.0	75	Z7.280.6227.0	127	Z7.280.6727.0	77
Z7.261.1427.0	168	Z7.268.0227.0	90	Z7.280.6227.0	137	Z7.280.6727.0	101
Z7.261.1527.0	14	Z7.268.0227.0	90	Z7.280.6227.0	139	Z7.280.6727.0	109
Z7.261.1527.0	22	Z7.268.0227.0	168	Z7.280.6227.0	142	Z7.280.6727.0	111
Z7.261.1527.0	22	Z7.268.0327.0	75	Z7.280.6227.0	142	Z7.280.6727.0	139
Z7.261.1527.0	23	Z7.268.0327.0	168	Z7.280.6227.0	142	Z7.280.6727.0	168
Z7.261.1527.0	23	Z7.268.0427.0	75	Z7.280.6227.0	143	Z7.280.6827.0	77
Z7.261.1527.0	25	Z7.268.0427.0	168	Z7.280.6227.0	143	Z7.280.6827.0	101
Z7.261.1527.0	25	Z7.268.0527.0	75	Z7.280.6227.0	168	Z7.280.6827.0	109
Z7.261.1527.0	79	Z7.268.0527.0	90	Z7.280.6327.0	14	Z7.280.6827.0	111
Z7.261.1527.0	99	Z7.268.0527.0	90	Z7.280.6327.0	77	Z7.280.6827.0	139
Z7.261.1527.0	102	Z7.268.0527.0	168	Z7.280.6327.0	93	Z7.280.6827.0	168
Z7.261.1527.0	103	Z7.268.1027.0	75	Z7.280.6327.0	95	Z7.280.6927.0	77
Z7.261.1527.0	105	Z7.268.1027.0	90	Z7.280.6327.0	97	Z7.280.6927.0	101
Z7.261.1527.0	168	Z7.268.1027.0	90	Z7.280.6327.0	101	Z7.280.6927.0	109
Z7.261.1627.0	79	Z7.268.1027.0	168	Z7.280.6327.0	109	Z7.280.6927.0	111
Z7.261.1627.0	99	Z7.268.2027.0	75	Z7.280.6327.0	111	Z7.280.6927.0	139
Z7.261.1627.0	102	Z7.268.2027.0	90	Z7.280.6327.0	124	Z7.280.6927.0	168
Z7.261.1627.0	103	Z7.268.2027.0	90	Z7.280.6327.0	126	Z7.280.7027.0	14
Z7.261.1627.0	105	Z7.268.2027.0	168	Z7.280.6327.0	126	Z7.280.7027.0	23
Z7.261.1627.0	168	Z7.269.2923.0	65	Z7.280.6327.0	126	Z7.280.7027.0	77
Z7.261.1727.0	79	Z7.269.3023.0	66	Z7.280.6327.0	127	Z7.280.7027.0	93
Z7.261.1727.0	99	Z7.269.3123.0	66	Z7.280.6327.0	127	Z7.280.7027.0	95
Z7.261.1727.0	102	Z7.269.3223.0	67	Z7.280.6327.0	137	Z7.280.7027.0	97
Z7.261.1727.0	103	Z7.269.3423.0	67	Z7.280.6327.0	139	Z7.280.7027.0	101
Z7.261.1727.0	105	Z7.269.3523.0	65	Z7.280.6327.0	142	Z7.280.7027.0	109
Z7.261.1727.0	168	Z7.270.0227.0	27	Z7.280.6327.0	142	Z7.280.7027.0	111
Z7.261.1827.0	79	Z7.270.0227.0	28	Z7.280.6327.0	142	Z7.280.7027.0	124
Z7.261.1827.0	99	Z7.270.0327.0	27	Z7.280.6327.0	143	Z7.280.7027.0	126
Z7.261.1827.0	102	Z7.270.0327.0	28	Z7.280.6327.0	143	Z7.280.7027.0	126
Z7.261.1827.0	103	Z7.270.1227.0	27	Z7.280.6327.0	168	Z7.280.7027.0	126
Z7.261.1827.0	105	Z7.270.1227.0	28	Z7.280.6427.0	14	Z7.280.7027.0	127
Z7.261.1827.0	168	Z7.271.2227.0	56	Z7.280.6427.0	77	Z7.280.7027.0	127
Z7.261.1927.0	79	Z7.271.2327.0	56	Z7.280.6427.0	93	Z7.280.7027.0	137
Z7.261.1927.0	99	Z7.271.3227.0	56	Z7.280.6427.0	95	Z7.280.7027.0	139
Z7.261.1927.0	102	Z7.271.4227.0	39	Z7.280.6427.0	97	Z7.280.7027.0	142
Z7.261.1927.0	103	Z7.271.4327.0	39	Z7.280.6427.0	101	Z7.280.7027.0	142
Z7.261.1927.0	105	Z7.271.5227.0	39	Z7.280.6427.0	109	Z7.280.7027.0	142
Z7.261.1927.0	168	Z7.271.5227.0	62	Z7.280.6427.0	111	Z7.280.7027.0	143
Z7.261.2027.0	14	Z7.271.5227.0	62	Z7.280.6427.0	126	Z7.280.7027.0	143
Z7.261.2027.0	22	Z7.271.5227.0	62	Z7.280.6427.0	127	Z7.280.7027.0	168
Z7.261.2027.0	22	Z7.271.5227.0	63	Z7.280.6427.0	127	Z7.280.8027.0	14
Z7.261.2027.0	23	Z7.271.5227.0	63	Z7.280.6427.0	137	Z7.280.8027.0	23
Z7.261.2027.0	23	Z7.280.0227.0	29	Z7.280.6427.0	139	Z7.280.8027.0	77
Z7.261.2027.0	25	Z7.280.0327.0	29	Z7.280.6427.0	168	Z7.280.8027.0	93
Z7.261.2027.0	25	Z7.280.0627.0	29	Z7.280.6527.0	14	Z7.280.8027.0	95
Z7.261.2027.0	79	Z7.280.2227.0	24	Z7.280.6527.0	23	Z7.280.8027.0	97
Z7.261.2027.0	99	Z7.280.2227.0	37	Z7.280.6527.0	77	Z7.280.8027.0	101
Z7.261.2027.0	102	Z7.280.2327.0	24	Z7.280.6527.0	93	Z7.280.8027.0	109
Z7.261.2027.0	103	Z7.280.2327.0	37	Z7.280.6527.0	95	Z7.280.8027.0	111
Z7.261.2027.0	105	Z7.280.3227.0	24	Z7.280.6527.0	97	Z7.280.8027.0	137
Z7.261.2027.0	123	Z7.280.3227.0	37	Z7.280.6527.0	101	Z7.280.8027.0	139
Z7.261.2027.0	124	Z7.280.6227.0	14	Z7.280.6527.0	109	Z7.280.8027.0	142
Z7.261.2027.0	168	Z7.280.6227.0	23	Z7.280.6527.0	111	Z7.280.8027.0	142
Z7.267.0227.5	27	Z7.280.6227.0	77	Z7.280.6527.0	126	Z7.280.8027.0	142
Z7.267.0227.5	28	Z7.280.6227.0	93	Z7.280.6527.0	127	Z7.280.8027.0	143
Z7.267.0227.6	27	Z7.280.6227.0	95	Z7.280.6527.0	127	Z7.280.8027.0	143
Z7.267.0227.6	28	Z7.280.6227.0	97	Z7.280.6527.0	137	Z7.280.8027.0	168
Z7.267.0327.5	27	Z7.280.6227.0	101	Z7.280.6527.0	139	Z7.281.1227.0	39
Z7.267.0327.5	28	Z7.280.6227.0	109	Z7.280.6527.0	168	Z7.281.1327.0	39
Z7.267.0327.6	27	Z7.280.6227.0	111	Z7.280.6627.0	77	Z7.281.2227.0	39
Z7.267.0327.6	28	Z7.280.6227.0	124	Z7.280.6627.0	101	Z7.281.3227.0	38
Z7.267.1227.5	27	Z7.280.6227.0	126	Z7.280.6627.0	109	Z7.281.3327.0	38
Z7.267.1227.5	28	Z7.280.6227.0	126	Z7.280.6627.0	111	Z7.281.3627.0	38
Z7.267.1227.6	27	Z7.280.6227.0	126	Z7.280.6627.0	139	Z7.282.2227.0	46





# INDEX

PART NUMBER | PAGE

Z7.282.2327.0	46	Z7.284.7227.0	134
Z7.282.3227.0	46	Z7.284.7227.0	134
Z7.282.4227.0	124	Z7.284.7227.0	168
Z7.282.5227.0	14	Z7.284.7227.5	135
Z7.282.5227.0	80	Z7.284.7227.6	135
Z7.282.5227.0	87	Z7.284.7327.0	132
Z7.282.5227.0	141	Z7.284.7327.0	134
Z7.282.5227.0	168	Z7.284.7327.0	134
Z7.282.5327.0	14	Z7.284.7327.0	168
Z7.282.5327.0	80	Z7.284.7327.5	135
Z7.282.5327.0	87	Z7.284.7327.6	135
Z7.282.5327.0	141	Z7.284.7427.0	132
Z7.282.5427.0	14	Z7.284.7427.0	134
Z7.282.5427.0	80	Z7.284.7427.0	134
Z7.282.5427.0	87	Z7.284.7427.0	168
Z7.282.5427.0	141	Z7.284.7427.5	135
Z7.282.5527.0	14	Z7.284.7427.6	135
Z7.282.5527.0	80	Z7.284.9227.0	61
Z7.282.5527.0	87	Z7.284.9327.0	61
Z7.282.5527.0	141	Z7.284.9427.0	61
Z7.282.5527.0	168	Z7.284.9527.0	61
Z7.282.6229.0	43	Z7.285.2227.0	16
Z7.282.6329.0	43	Z7.285.2327.0	16
Z7.282.6429.0	43	Z7.285.2627.0	16
Z7.282.6529.0	43	Z7.285.3227.0	16
Z7.282.6629.0	43	Z7.285.4227.0	61
Z7.282.7229.0	43	Z7.285.4327.0	61
Z7.282.7329.0	43	Z7.285.4427.0	61
Z7.282.7429.0	43	Z7.285.4527.0	61
Z7.283.2227.0	46	Z7.285.6227.0	82
Z7.283.2227.0	47	Z7.285.6227.0	89
Z7.283.2227.0	61	Z7.285.6227.0	168
Z7.283.2327.0	46	Z7.285.6427.0	81
Z7.283.2327.0	47	Z7.285.6427.0	83
Z7.283.2327.0	61	Z7.285.6427.0	168
Z7.283.2427.0	61	Z7.286.3227.0	16
Z7.283.2527.0	61	Z7.286.3327.0	16
Z7.283.3227.0	46	Z7.286.3627.0	16
Z7.283.3227.0	47	Z7.287.0227.0	35
Z7.283.8227.0	15	Z7.287.0327.0	35
Z7.283.8227.0	81	Z7.287.0627.0	35
Z7.283.8227.0	89	Z7.287.1227.0	16
Z7.283.8227.0	123	Z7.287.1327.0	16
Z7.283.8227.0	125	Z7.311.1755.0	167
Z7.283.8227.0	168	Z7.311.2755.0	167
Z7.284.4227.0	15	Z7.311.7055.0	167
Z7.284.4227.0	82	Z7.409.5753.0	54
Z7.284.4227.0	82	Z7.409.5853.0	54
Z7.284.4227.0	89	Z7.409.5853.0	55
Z7.284.4227.0	123	Z7.409.5853.0	55
Z7.284.4227.0	125		
Z7.284.4227.0	125		
Z7.284.4227.0	168		
Z7.284.7027.0	132		
Z7.284.7027.0	134		
Z7.284.7027.0	134		
Z7.284.7027.0	168		
Z7.284.7027.5	135		
Z7.284.7027.6	135		
Z7.284.7127.0	132		
Z7.284.7127.0	134		
Z7.284.7127.0	134		
Z7.284.7127.0	168		
Z7.284.7127.5	135		
Z7.284.7127.6	135		
Z7.284.7227.0	132		



# CUSTOMIZED ASSEMBLY

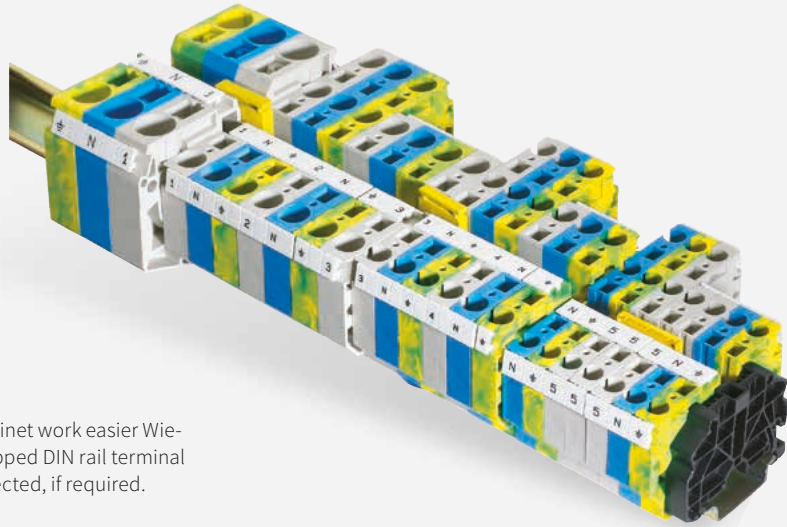

## TERMINAL BLOCK ASSEMBLIES

For those who want to make their control cabinet work easier Wieland Electric pre-assembles completely equipped DIN rail terminal block assemblies, even with the cables connected, if required.

## CABLE ASSEMBLIES

Individual cables tailored to your needs and combined with various components can be delivered for your project in all lengths.



## CONTROL AND DISTRIBUTION PANELS

Our value-add departments will gladly assist you in selecting individual Wieland components, or in laying out complete panels, which we can also build for you.

## INTERFACE MODULES – SOLUTION SPECIFIC CONNECTIVITY

Each control cabinet requires distribution functionality. In most cases this is accomplished with standard control panel wiring (0.5 mm or 1.5 mm fine stranded with ferrule) to standardized interfaces (d-sub or ribbon cables). Upon the customer's request Wieland Electric can design individual and customized solutions for all applications, too.

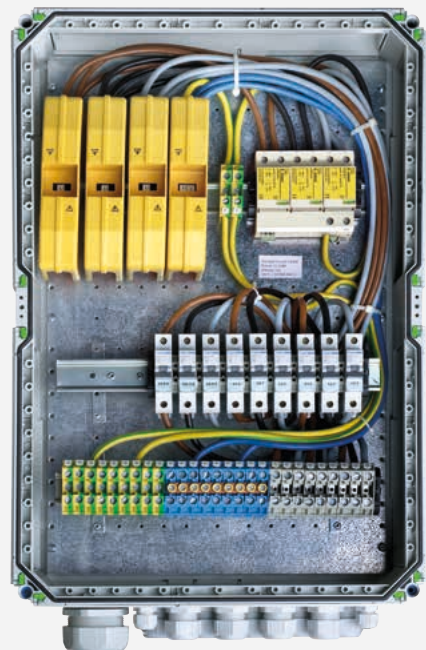
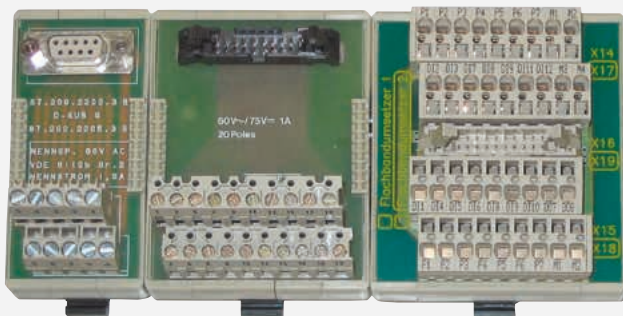



# YOUR CONTACT PARTNERS.



INDUSTRIAL AUTOMATION,  
ELECTROMECHANICS

Phone: **+49 951 9324-991**  
Mail: **AT.TS@wieland-electric.com**

BUILDING AND INSTALLATION  
TECHNOLOGY

Phone: **+49 951 9324-996**  
Mail: **BIT.TS@wieland-electric.com**

INDUSTRIAL AUTOMATION, ELECTRONICS

Phone: **+49 951 9324-995**  
Mail: **AT.TS@wieland-electric.com**

SAFETY TECHNOLOGY

Phone: **+49 951 9324-999**  
Mail: **safety@wieland-electric.com**



**WIELAND ON YouTube**  
FIND OUT MORE ABOUT  
OUR PRODUCTS



<https://www.youtube.com/user/WielandElectric>



OUR **SUBSIDIARIES**  
AND OUR SALES PARTNER



Contact your local partner:  
[www.wieland-electric.com](http://www.wieland-electric.com)



## ONLY ONE TIP AWAY.

**OUR WIELAND E-SHOP**  
EVERY PRODUCT - ANY TIME

In our online store you will find all the information about our products, prices, and technical data. Order easily and conveniently online, and check availability.

<https://eshop.wieland-electric.com>

Scan QR code – view  
products in the  
E-SHOP.





# wieland

## HEADQUARTERS

Wieland Electric GmbH  
Brennerstraße 10 – 14  
96052 Bamberg · Germany

---

Phone +49 951 9324-0  
Fax +49 951 9324-198  
info@wieland-electric.com

0500.1 S 11/18

Represented in over 70 countries worldwide:

[www.wieland-electric.com](http://www.wieland-electric.com)